

ARTESYN CSV1600BP

1600 Watts Distributed Power System



Advanced Energy's Artesyn CSV series bulk front end power AC-DC supply is designed for systems where scalability and density are requirements. With multiple power levels to choose from, this family provides designers with the ability to change the power supply to optimize according to system power consumption.

SPECIAL FEATURES

- 1600 W output power
- 1U power supply
- Active Power Factor Correction
- EN61000-3-2 Harmonic compliance
- Inrush current control
- 80PLUS® Platinum efficiency
- N+N Redundant
- Hot-pluggable
- Active current sharing
- PMBus® compliant
- Two-year warranty

SAFETY

- UL/cUL
- CB Test Certificate
- CE Mark
- KC
- CCC/CQC
- BSMI
- BIS
- TÜV

COMPLIANCE

- Conducted/Radiated EMI Class A Limits
- RoHS
- IEC 60950

DATA SHEET

Front-end Bulk Power

Total Output Power:

1600 W continuous at high line

Input Voltage:

180 to 264 Vac



ELECTRICAL SPECIFICATIONS

Input						
Input range	180 - 264 Vac: 1600 W					
Frequency	47 Hz to 63 Hz					
Efficiency	94.0% peak					
Max input current	8.7 A @ 200 Vac					
Inrush current	30 Apk					
Conducted EMI	Class A					
Radiated EMI	Class A					
Power factor	>0.9 beginning at 10% load					
Hold-up time	12 ms at full load					
Leakage current	0.575 mA					
Output						
	Main DC Output			Standby DC Output		
	MIN	NOM	MAX	MIN	NOM	MAX
Nominal setting	-0.20%	12.2	0.20%	-3.5%	12.0	+3.5%
Total output regulation range	11.6 V		12.8 V	11.4 V		12.6 V
Dynamic load regulation range	11.6 V		12.8 V	11.4 V		12.6 V
Output ripple			120 mVp-p			120 mVp-p
Output current	1.0 A ¹		131.2 A	0.0 A		2.5 A
Current sharing	Within ±10% of full load rating, starting at 30% of rated load			N/A		
Capacitive loading	1,000 µF		20,000 µF	50 µF		500 µF
Start-up from AC to output			3,000 ms			2,500 ms
Output rise time	5 ms		50 ms	1 ms		25 ms

¹ Minimum current for transient load response testing only. Unit is designed to operate and be within output regulation range at zero load.

Protections			
Main Output	MIN	NOM	MAX
Overcurrent protection ²	>100%		125%
Overvoltage protection ¹	13.4 V		
Undervoltage protection			10.0 V
Overtemperature protection		Yes	
Fan fault protection		Yes	
Standby Output			
Overcurrent protection ³	3.85 A		3.95 A
Overvoltage protection ³	13.4 V		
Undervoltage protection			10.0 V

¹ Latch mode

² THROTTLE warning of at least 1 second before latching off

³ Standby protection is auto-recovery

ELECTRICAL SPECIFICATIONS (CONTINUED)

LED Indicators			
	Input Good (Green)	Output Good (Green)	Fault (Yellow)
Output ON and OK	On	On	Off
Standby mode (input present, main output off) or zero output mode	On	Blinking 1 Hz	Off
No input/Input out of range	Off	Off	Off
OCP, or over-subscription fault, or OVP, or fan failure, or OTP	On	Off	On

ENVIRONMENTAL SPECIFICATIONS

Operating temperature	5 to 50 °C ¹
Operating altitude	up to 10,000 feet ¹
Operating relative humidity	+8% to 93%, non-condensing
Non-operating temperature	-40 to +60 °C
Shipping and storage relative humidity	+5% to 100%, including condensing
Non-operating altitude	up to 50,000 feet
Vibration and shock	Standard operating/non-operating random shock and vibration
RoHS compliance	Yes
MTBF	500 k hours at 40 °C, 70% load, nominal input
Operating life	Minimum of 5 years at typical conditions

¹ Allowable operation up to 60°C at 70% load. PSU ambient temperature derated at 1 °C per 600 ft above 3000 ft

ORDERING INFORMATION

Model Name	Ordering Part Number	Nominal Main Output	Standby Output	Airflow Direction
CSV1600BP-3	700-014190-1000	12.2 V @ 131.2 A	12 V @ 3.0 A	Standard (forward)

TIMING DIAGRAM

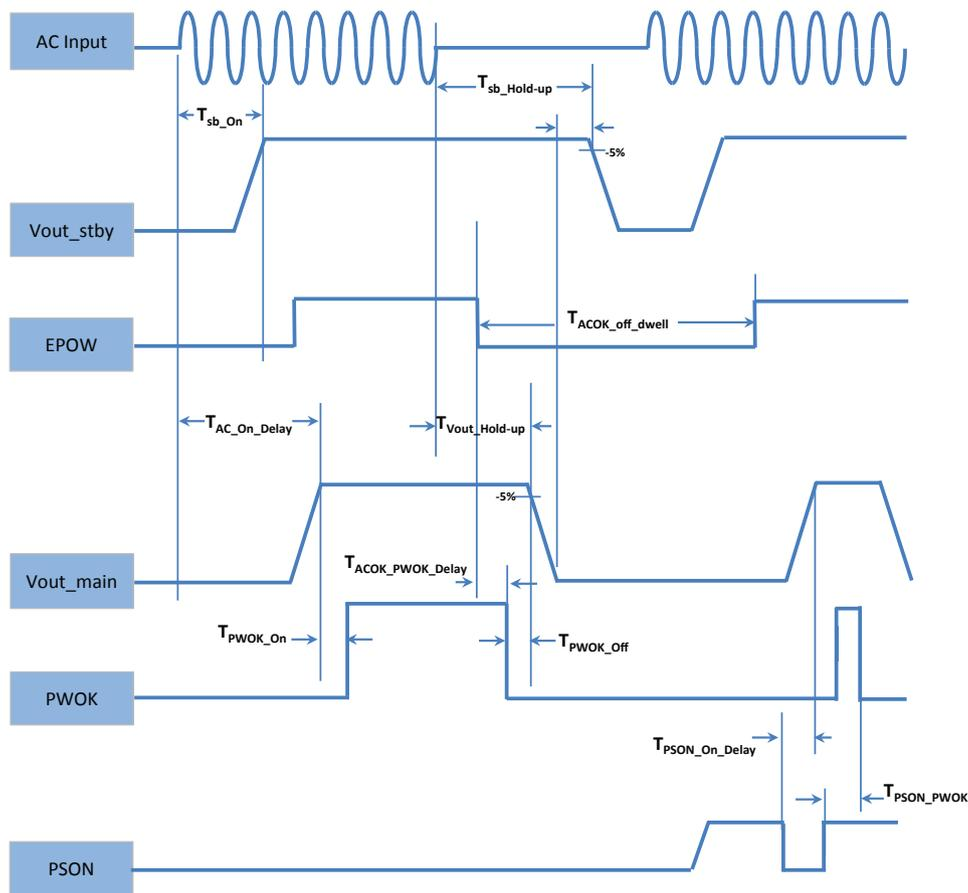

Timing Specifications				
	Description	Min	Max	Unit
T _{sb_On}	Delay from AC being applied to standby output being within regulation		2500	ms
T _{Vout_rise}	Rise time of output voltage going from 10% to 90% of the nominal regulation	1	50	ms
T _{AC_On_Delay}	Delay from AC being applied to main output being within regulation		3000	ms
T _{PWOK_On}	Delay from output voltages within regulation limits to PWOK assertion	180	220	ms
T _{ACOK_PWOK_Delay}	Delay from ACOK going low to deassertion of PWOK	6		ms
T _{Vout_Hold-up}	Delay from loss of AC to main output being within regulation	12		ms
T _{sb_Hold-up}	Delay from loss of AC to standby output being within regulation	50	1000	ms
T _{PWOK_Off}	Delay from deassertion of PWOK to output falling out of regulation	2		ms
T _{PSON_PWOK}	Delay from deassertion of PSON to deassertion of PWOK		1	ms
T _{PSON_On_Delay}	Delay from PSON assertion to output being within regulation	5	100	ms

MECHANICAL OUTLINE

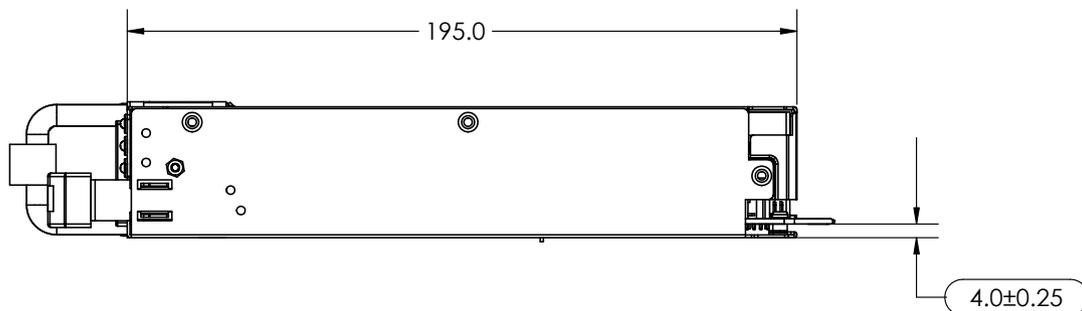
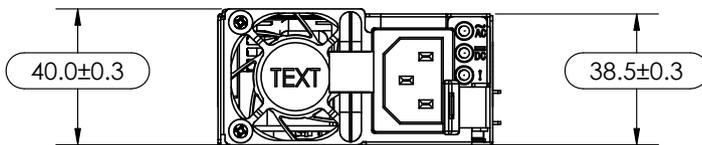
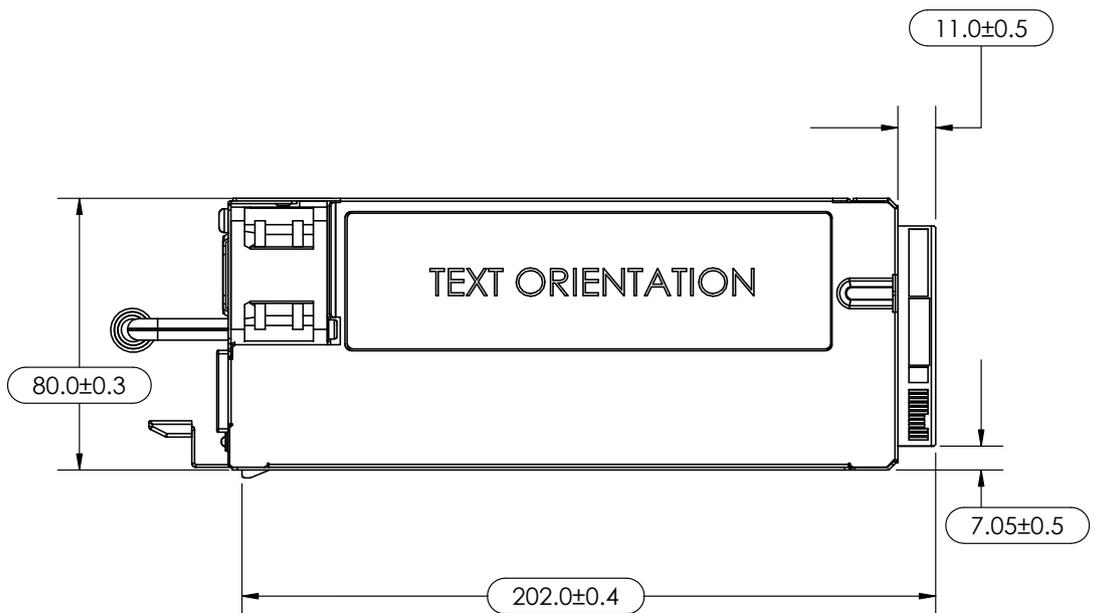

DIMENSION AND TOLERANCE NEED TO BE HELD AT THE EDGE OF THE STANDOFF LOCATIONS ONLY

CONNECTOR DEFINITIONS

Output connector part number	Card-edge
Mating connector part number	FCI Amphenol HPCE 10122238-320424FLF

Power Supply Output Card Edge (Top Side)

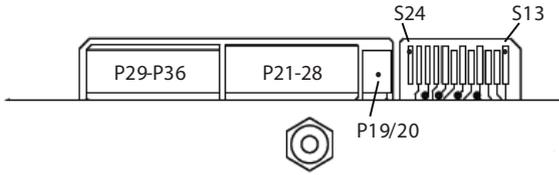

Power Supply Output Card Edge (Bottom Side)

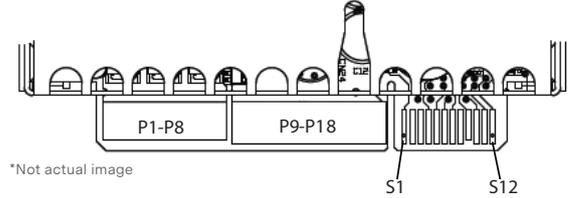

Output Connector Pin Configuration			
S1	Reserved	S13	SMBUS_RESET
S2	Reserved	S14	Reserved
S3	+Vsense	S15	ADDRESS
S4	PSKILL	S16	PSON
S5	Reserved	S17	PSON
S6	PWOK	S18	ACOK
S7	PRESENT	S19	Reserved
S8	SMB_ALERT#	S20	THROTTLE
S9	ISHARE	S21	Reserved
S10	RETURN	S22	-Vsense
S11	SDA	S23	Reserved
S12	SCL	S24	Reserved
P1-P8	Vo	P29-P36	Vo
P9-P18	RTN	P21-P28	RTN
		P19-P20	VSB

Power Supply Addressing (pin S15)		
Resistance (pull-down at system side, 1% tol or better)	Voltage (nom)	Hex Address
OPEN	12.00 V	D0
280 k	10.49 V	D2
212 k	9.01 V	D4
68.1 k	7.55 V	D6
40.2 k	6.00 V	D8
23.7 k	4.45 V	DA
13.3 k	2.98 V	DC
5.76 k	1.50 V	DE



For international contact information,
visit advancedenergy.com.

powersales@aei.com (Sales Support)
productsupport.ep@aei.com (Technical Support)
+1 888 412 7832

ABOUT ADVANCED ENERGY

Advanced Energy (AE) has devoted more than three decades to perfecting power for its global customers. AE designs and manufactures highly engineered, precision power conversion, measurement and control solutions for mission-critical applications and processes.

Our products enable customer innovation in complex applications for a wide range of industries including semiconductor equipment, industrial, manufacturing, telecommunications, data center computing, and medical. With deep applications know-how and responsive service and support across the globe, we build collaborative partnerships to meet rapid technological developments, propel growth for our customers, and innovate the future of power.

PRECISION | POWER | PERFORMANCE

Specifications are subject to change without notice. Not responsible for errors or omissions. ©2020 Advanced Energy Industries, Inc. All rights reserved. Advanced Energy®, AE® and Artesyn™ are U.S. trademarks of Advanced Energy Industries, Inc.