

CE EMC TEST REPORT

for

DC /DC Power Converter

Model: ERM01 、ERM04 Series & ERM00 、ERM02 Series

Brand: **ARTESYN™**
EMBEDDED TECHNOLOGIES

Test Report Number:
T160519N02-E1

Issued to:

Artesyn Embedded Technologies

16th Floor, Lu Plaza 2 Wing Yip Street, Kwun Tong, Kowloon, Hong Kong

Issued by:

Compliance Certification Services Inc.

Tainan Lab.

No.8,Jiucengling, Xinhua Dist., Tainan City
712, Taiwan (R.O.C.)

TEL: 886-6-5802201

FAX: 886-6-5802202

Issued Date: March 1, 2017



Note: This report shall not be reproduced except in full, without the written approval of Compliance Certification Services Inc. This document may be altered or revised by Compliance Certification Services Inc. personnel only, and shall be noted in the revision section of the document. The client should not use it to claim product endorsement by TAF, NIST or any government agencies. The test results in the report only apply to the tested sample.

REVISION HISTORY

Rev.	Issue Date	Revisions	Effect Page	Revised By
00	March 1, 2017	Initial Issue	ALL	Eva Lin

TABLE OF CONTENTS

1 TEST CERTIFICATION.....	4
2 TEST RESULT SUMMARY	5
3 EUT DESCRIPTION.....	6
4 TEST METHODOLOGY	16
4.1. DECISION OF FINAL TEST MODE.....	16
4.2. EUT SYSTEM OPERATION	16
5 SETUP OF EQUIPMENT UNDER TEST	17
5.1. DESCRIPTION OF SUPPORT UNITS.....	17
5.2. CONFIGURATION OF SYSTEM UNDER TEST	17
6 FACILITIES AND ACCREDITATIONS	18
6.1. FACILITIES	18
6.2. ACCREDITATIONS	18
6.3. MEASUREMENT UNCERTAINTY.....	19
7 EMISSION TEST.....	20
7.1. CONDUCTED EMISSION MEASUREMENT	20
7.2. CONDUCTED EMISSION MEASUREMENT AT ANALOGUE/DIGITAL DATA PORTS ...	39
7.3. RADIATED EMISSION MEASUREMENT.....	42
7.4. HARMONICS CURRENT MEASUREMENT	63
7.5. VOLTAGE FLUCTUATION AND FLICKER MEASUREMENT	65
8 IMMUNITY TEST	67
8.1. GENERAL DESCRIPTION	67
8.2. GENERAL PERFORMANCE CRITERIA DESCRIPTION.....	68
8.3. ELECTROSTATIC DISCHARGE (ESD)	69
8.4. RADIATED, RADIO-FREQUENCY, ELECTROMAGNETIC FIELD (RS)	78
8.5. ELECTRICAL FAST TRANSIENT (EFT)	82
8.6. SURGE IMMUNITY TEST	85
8.7. CONDUCTED RADIO FREQUENCY DISTURBANCES (CS).....	88
8.8. POWER FREQUENCY MAGNETIC FIELD	91
8.9. VOLTAGE DIPS & VOLTAGE INTERRUPTIONS	95
9 PHOTOGRAPHS OF THE TEST CONFIGURATION	97
APPENDIX 1 - PHOTOGRAPHS OF EUT.....	A1

1 TEST CERTIFICATION

Product:	DC /DC Power Converter	
Model:	ERM01 、ERM04 Series & ERM00 、ERM02 Series	
Brand:		
Applicant:	Artesyn Embedded Technologies 16th Floor, Lu Plaza 2 Wing Yip Street, Kwun Tong, Kowloon, Hong Kong	
Tested:	May 03, 2016 ~ May 12, 2016	
Applicable Standards:	EN 55032: 2012+AC: 2013, Class A	EN 55024: 2010 IEC 61000-4-2: 2008 IEC 61000-4-3: 2010 IEC 61000-4-4: 2012 IEC 61000-4-5: 2014 IEC 61000-4-6: 2013 IEC 61000-4-8: 2009

Deviation from Applicable Standard
None

The above equipment was tested by Compliance Certification Services Inc. for compliance with the requirements of technical standards specified above under the EMC Directive 2014/30/EU. The results of testing in this report apply only to the product/system, which was tested. Other similar equipment will not necessarily produce the same results due to production tolerance and measurement uncertainties.

Approved by:



Jeter Wu
Assistant Manager

Reviewed by:

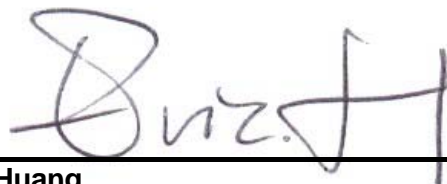

Eric Huang
Assistant Section Manager

2 TEST RESULT SUMMARY

EMISSION			
Standard	Item	Result	Remarks
EN 55032: 2012+AC: 2013	Conducted (Power Port)	PASS	Meet Class A limit
	Conducted (Analogue/Digital Data Ports)	N/A	No requirement
	Radiated (Below 1GHz)	PASS	Meet Class A limit
	Radiated (Above 1GHz)	N/A	No requirement
EN 61000-3-2: 2014	Harmonic current emissions	N/A	No requirement
EN 61000-3-3: 2013	Voltage fluctuations & flicker	N/A	No requirement

IMMUNITY [EN 55024: 2010]			
Standard	Item	Result	Remarks
IEC 61000-4-2: 2008	ESD	PASS	Meets the requirements of Performance Criterion A
IEC 61000-4-3: 2010	RS	PASS	Meets the requirements of Performance Criterion A
IEC 61000-4-4: 2012	EFT	PASS	Meets the requirements of Performance Criterion A
IEC 61000-4-5: 2014	Surge	PASS	Meets the requirements of Performance Criterion A
IEC 61000-4-6: 2013	CS	PASS	Meets the requirements of Performance Criterion A
IEC 61000-4-8: 2009	PFMF	PASS	Meets the requirements of Performance Criterion A
IEC 61000-4-11: 2004	Voltage dips & voltage variations	N/A	Meets the requirements of Voltage Dips: 1) >95% reduction Performance Criterion --- 2) 30% reduction Performance Criterion --- Voltage Interruptions: 1) >95% reduction Performance Criterion ---

Note:

1. The statements of test result on the above are decided by the request of test standard only; the measurement uncertainties are not factored into this compliance determination.
2. The information of measurement uncertainty is available upon the customer's request.

3 EUT DESCRIPTION

Product	DC /DC Power Converter
Model	ERM01 、ERM04 Series & ERM00 、ERM02 Series
Brand Name	
Applicant	Artesyn Embedded Technologies
Housing material	Plastics
Identify Number	T160519N02-E1
Received Date	May 19, 2016
EUT Power Rating	See Below
EUT Size(L*W*H)	5.5 * 3.0 * 2.0 (cm)

I/O PORT

I/O PORT TYPES	Q'TY	TESTED WITH
1. DC IN	1	DC Power Supply
2. DC OUT	1	R-Load

Note:

- Client consigns only eight model samples to test
(Model Number: **ERM00CC18-HS, ERM02A18-HS, ERM00CC110-HS, ERM02A110-HS, ERM01CC18-HS, ERM04A18-HS, ERM01CC110-HS, ERM04A110-HS**). Therefore, the testing Lab. just guarantees the unit, which has been tested.
- For more details, please refer to the User's manual of the EUT.

3. To add a series model is for business necessary. The different of the each model is shown as below:

Model Number	Input Voltage (Range)	Output Voltage
	VDC	VDC
<u>ERM00、ERM02 Series</u>		
ERM02A18	24 (9~36)	5
ERM00B18		12
ERM00C18		15
ERM00H18		24
ERM00B18		±12
ERM00C18		±15
ERM02A36	48 (18~75)	5
ERM00B36		12
ERM00C36		15
ERM00H36		24
ERM00BB36		±12
ERM00CC36		±15
ERM02A110	110 (40~160)	5
ERM00B110		12
ERM00C110		15
ERM00H110		24
ERM00BB110		±12
ERM00CC110		±15

<u>ERM01 \ ERM04 Series</u>		
ERM04A18	24 (9~36)	5
ERM01B18		12
ERM01C18		15
ERM01H18		24
ERM01BB18		±12
ERM01CC18		±15
ERM04A36	48 (18~75)	5
ERM01B36		12
ERM01C36		15
ERM01H36		24
ERM01BB36		±12
ERM01CC36		±15
ERM04A110	110 (40~160)	5
ERM01B110		12
ERM01C110		15
ERM01H110		24
ERM01BB110		±12
ERM01CC110		±15

Order Code Table	
Standard	With heatsink
<u>ERM00 - ERM02 Series</u>	
ERM02A18	ERM02A18-HS
ERM00B18	ERM00B18-HS
ERM00C18	ERM00C18-HS
ERM00H18	ERM00H18-HS
ERM00B18	ERM00BB18-HS
ERM00C18	ERM00CC18-HS
ERM02A36	ERM02A36-HS
ERM00B36	ERM00B36-HS
ERM00C36	ERM00C36-HS
ERM00H36	ERM00H36-HS
ERM00BB36	ERM00BB36-HS
ERM00CC36	ERM00CC36-HS
ERM02A110	ERM02A110-HS
ERM00B110	ERM00B110-HS
ERM00C110	ERM00C110-HS
ERM00H110	ERM00H110-HS
ERM00BB110	ERM00BB110-HS
ERM00CC110	ERM00CC110-HS

<u>ERM01 \ ERM04 Series</u>	
ERM04A18	ERM04A18-HS
ERM01B18	ERM01B18-HS
ERM01C18	ERM01C18-HS
ERM01H18	ERM01H18-HS
ERM01BB18	ERM01BB18-HS
ERM01CC18	ERM01CC18-HS
ERM04A36	ERM04A36-HS
ERM01B36	ERM01B36-HS
ERM01C36	ERM01C36-HS
ERM01H36	ERM01H36-HS
ERM01BB36	ERM01BB36-HS
ERM01CC36	ERM01CC36-HS
ERM04A110	ERM04A110-HS
ERM01B110	ERM01B110-HS
ERM01C110	ERM01C110-HS
ERM01H110	ERM01H110-HS
ERM01BB110	ERM01BB110-HS
ERM01CC110	ERM01CC110-HS

Order Code Table	
Package Specifications with "A" Pinning	With heatsink
<u>ERM00 · ERM02 Series</u>	
ERM02A18B	ERM02A18B-HS
ERM00B18B	ERM00B18B-HS
ERM00C18B	ERM00C18B-HS
ERM00H18B	ERM00H18B-HS
ERM00BB18B	ERM00BB18B-HS
ERM00CC18B	ERM00CC18B-HS
ERM02A36B	ERM02A36B-HS
ERM00B36B	ERM00B36B-HS
ERM00C36B	ERM00C36B-HS
ERM00H36B	ERM00H36B-HS
ERM00BB36B	ERM00BB36B-HS
ERM00CC36B	ERM00CC36B-HS
ERM02A110B	ERM02A110B-HS
ERM00B110B	ERM00B110B-HS
ERM00C110B	ERM00C110B-HS
ERM00H110B	ERM00H110B-HS
ERM00BB110B	ERM00BB110B-HS
ERM00CC110B	ERM00CC110B-HS

<u>ERM01 \ ERM04 Series</u>	
ERM04A18B	ERM04A18B-HS
ERM01B18B	ERM01B18B-HS
ERM01C18B	ERM01C18B-HS
ERM01H18B	ERM01H18B-HS
ERM01BB18B	ERM01BB18B-HS
ERM01CC18B	ERM01CC18B-HS
ERM04A36B	ERM04A36B-HS
ERM01B36B	ERM01B36B-HS
ERM01C36B	ERM01C36B-HS
ERM01H36B	ERM01H36B-HS
ERM01BB36B	ERM01BB36B-HS
ERM01CC36B	ERM01CC36B-HS
ERM04A110B	ERM04A110B-HS
ERM01B110B	ERM01B110B-HS
ERM01C110B	ERM01C110B-HS
ERM01H110B	ERM01H110B-HS
ERM01BB110B	ERM01BB110B-HS
ERM01CC110B	ERM01CC110B-HS

(1) Conducted & Radiated Solution :

External Filter meets Radiated EMI EN 55032 & EN 55022, class A ; FCC part 15 ,level A.

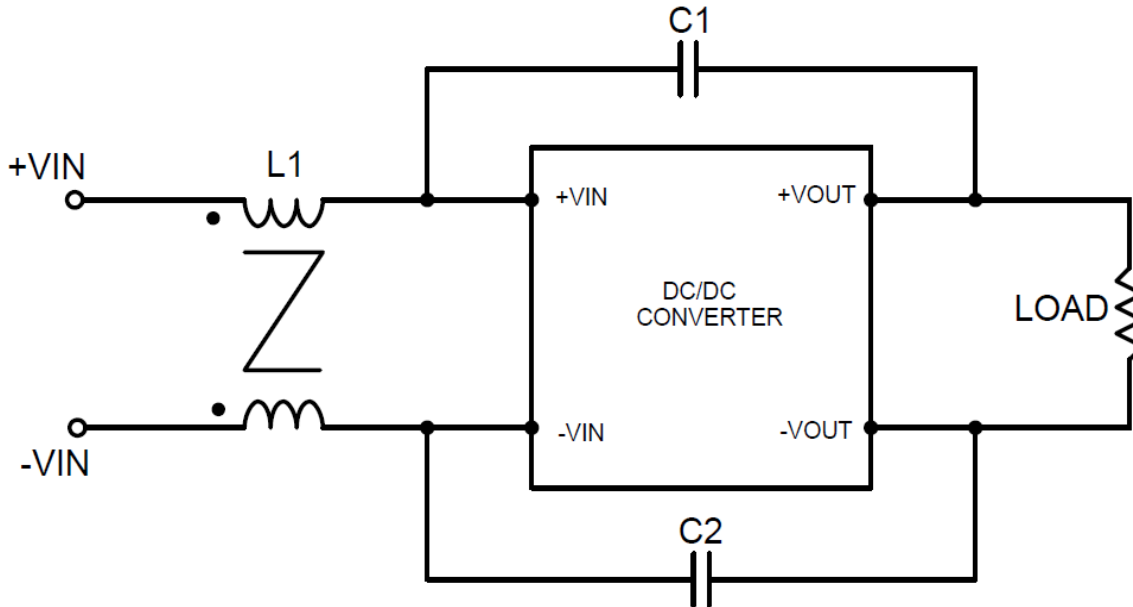

Class	Model	C1	C2	L1
Class A	ERM00XX18X; ERM02XX18X	---	2200pF Y1 Cap.	1mH/2A, 744821201
	ERM00XX36X; ERM02XX36X	47µF/100V/1210 X7R MLCC	2200pF Y1 Cap.	5mH/1A, 744821150
	ERM00XX110X; ERM02XX110X	---	2200pF Y1 Cap.	5mH/1A, 744821150
	ERM01XX18X; ERM04XX18X; ERM01XX36X; ERM04XX36X; ERM01XX110X; ERM04XX110X	2200pF Y1 Cap.	2200pF Y1 Cap.	175µH/10A, 74482210002

(2) EFT & Surge Solution :

To meet EN61000-4-4 & EN61000-4-5, an external capacitor across the input pins is required. Suggested capacitor as below:

Model	Suggested capacitor
ERM00XX18X; ERM02XX18X	CHEMI-CON KY Series 390uF/63V
ERM01XX18X; ERM04XX18X;	CHEMI-CON KY Series 390uF/63V

(3)Package Specifications :

Package Specifications																						
<p>Mechanical Dimensions</p> <p>The drawing shows a rectangular package with a bottom view and a side view. The bottom view shows six pins (1-6) and dimensions: 7.62 [0.30], 5.08 [0.20], 10.16 [0.40] for pin spacing; 3.3 [0.13] for pin 6 offset; 1.85 [0.07] for pin 6 height; 10.16 [0.40], 10.16 [0.40], 2.54 [0.10] for pin 1-3 spacing; 25.4 [1.00] for total width; 20.32 [0.80], 50.8 [2.00] for height; and 5.5 [0.22], 11.0 [0.43] for side view dimensions. The side view shows a diameter of $\varnothing 1.00$ [0.04].</p>	<p>Pin Connections</p> <table border="1"> <thead> <tr> <th>Pin</th> <th>Single Output</th> <th>Dual Output</th> </tr> </thead> <tbody> <tr> <td>1</td> <td>+Vin</td> <td>+Vin</td> </tr> <tr> <td>2</td> <td>-Vin</td> <td>-Vin</td> </tr> <tr> <td>3</td> <td>Remote On/Off</td> <td>Remote On/Off</td> </tr> <tr> <td>4</td> <td>+Vout</td> <td>+Vout</td> </tr> <tr> <td>5</td> <td>Trim</td> <td>Common</td> </tr> <tr> <td>6</td> <td>-Vout</td> <td>-Vout</td> </tr> </tbody> </table> <ul style="list-style-type: none"> ▶ All dimensions in mm (inches) ▶ Tolerance: X.X±0.5 (X.XX±0.02) X.XX±0.25 (X.XXX±0.01) ▶ Pin diameter ⇔ 1.0 ±0.05 (0.04±0.002) 	Pin	Single Output	Dual Output	1	+Vin	+Vin	2	-Vin	-Vin	3	Remote On/Off	Remote On/Off	4	+Vout	+Vout	5	Trim	Common	6	-Vout	-Vout
Pin	Single Output	Dual Output																				
1	+Vin	+Vin																				
2	-Vin	-Vin																				
3	Remote On/Off	Remote On/Off																				
4	+Vout	+Vout																				
5	Trim	Common																				
6	-Vout	-Vout																				

Package Specifications with "A" Pinning (order code suffix A)																						
<p>Mechanical Dimensions</p> <p>The drawing shows a rectangular package with a bottom view and a side view. The bottom view shows six pins (1-6) and dimensions: 10.16 [0.40], 5.08 [0.20], 5.08 [0.20] for pin spacing; 1.85 [0.07] for pin 6 height; 10.16 [0.40], 10.16 [0.40], 2.54 [0.10] for pin 1-3 spacing; 25.4 [1.00] for total width; 45.72 [1.80], 50.8 [2.00] for height; and 5.5 [0.22], 11.0 [0.43] for side view dimensions. The side view shows a diameter of $\varnothing 1.00$ [0.04].</p>	<p>Pin Connections</p> <table border="1"> <thead> <tr> <th>Pin</th> <th>Single Output</th> <th>Dual Output</th> </tr> </thead> <tbody> <tr> <td>1</td> <td>+Vin</td> <td>+Vin</td> </tr> <tr> <td>2</td> <td>-Vin</td> <td>-Vin</td> </tr> <tr> <td>3</td> <td>Remote On/Off</td> <td>Remote On/Off</td> </tr> <tr> <td>4</td> <td>+Vout</td> <td>+Vout</td> </tr> <tr> <td>5</td> <td>-Vout</td> <td>Common</td> </tr> <tr> <td>6</td> <td>Trim</td> <td>-Vout</td> </tr> </tbody> </table> <ul style="list-style-type: none"> ▶ All dimensions in mm (inches) ▶ Tolerance: X.X±0.5 (X.XX±0.02) X.XX±0.25 (X.XXX±0.01) ▶ Pin diameter ⇔ 1.0 ±0.05 (0.04±0.002) 	Pin	Single Output	Dual Output	1	+Vin	+Vin	2	-Vin	-Vin	3	Remote On/Off	Remote On/Off	4	+Vout	+Vout	5	-Vout	Common	6	Trim	-Vout
Pin	Single Output	Dual Output																				
1	+Vin	+Vin																				
2	-Vin	-Vin																				
3	Remote On/Off	Remote On/Off																				
4	+Vout	+Vout																				
5	-Vout	Common																				
6	Trim	-Vout																				

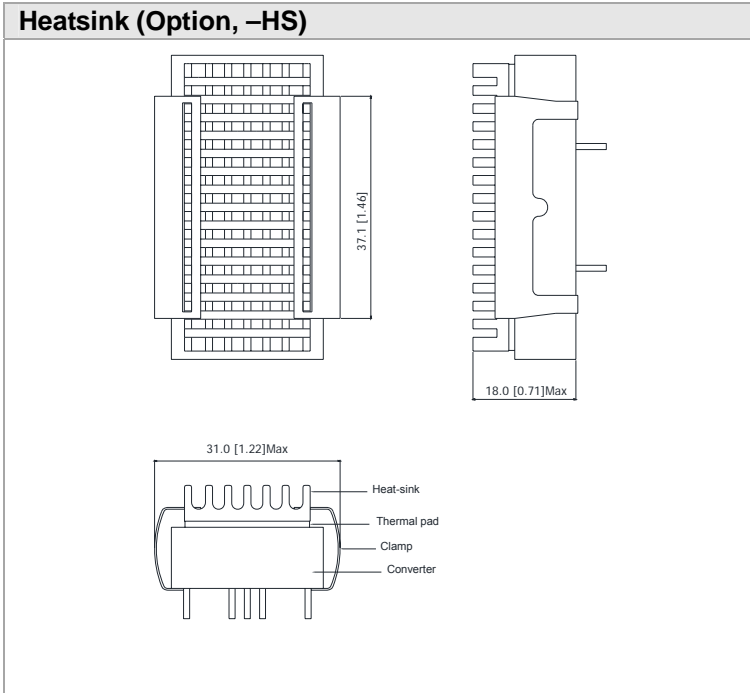

Physical Characteristics	
Heatsink Material	: Aluminum
Finish	: Black Anodized Coating
Weight	: 9g

► The advantages of adding a heatsink are:

1. To improve heat dissipation and increase the stability and reliability of the DC/DC converters at high operating temperatures.
2. To increase operating temperature of the DC/DC converter, please refer to Derating Curve.

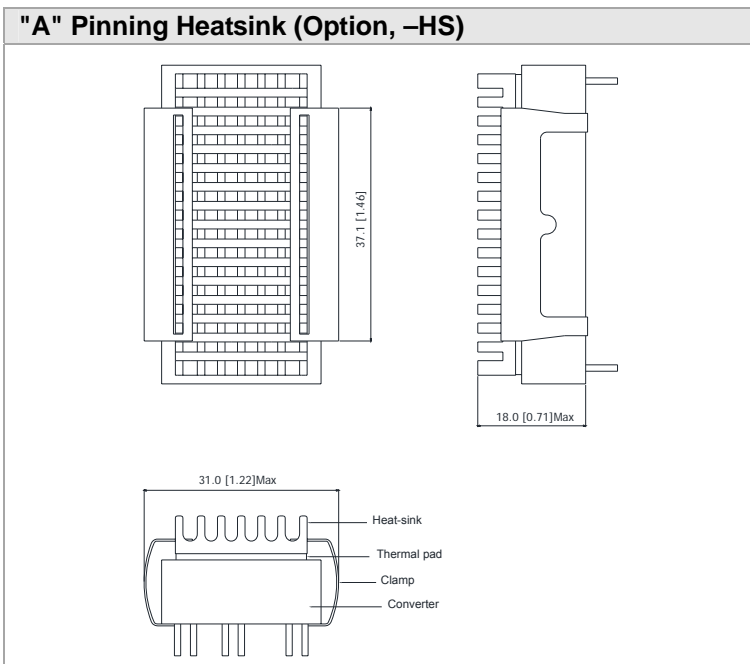

4 TEST METHODOLOGY

4.1. DECISION OF FINAL TEST MODE

The EUT was tested together with the above additional components, and a configuration, which produced the worst emission levels, was selected and recorded in this report.

The test configuration/ modes are as the following:

Conduction (Power port) Modes: (Full Load)

1.	ERM00CC18-HS	5.	ERM01CC18-HS
2.	ERM02A18-HS	6.	ERM04A18-HS
3.	ERM00CC110-HS	7.	ERM01CC110-HS
4.	ERM02A110-HS	8.	ERM04A110-HS

Conduction (Analogue/Digital Data Ports) Modes

1.	Non
----	-----

Radiation Modes: (Below 1GHz) (Full Load)

1.	ERM00CC18-HS	5.	ERM01CC18-HS
2.	ERM02A18-HS	6.	ERM04A18-HS
3.	ERM00CC110-HS	7.	ERM01CC110-HS
4.	ERM02A110-HS	8.	ERM04A110-HS

Radiation Modes: (Above 1GHz) (Full Load)

1.	Non
----	-----

Immunity Modes: (Full Load)

1.	ERM02A18-HS	2.	ERM04A18-HS
----	-------------	----	-------------

4.2. EUT SYSTEM OPERATION

1. Setup a whole system for test as shown on setup diagram.
2. Turn on power and check function.
3. Start to test by test mode.

5 SETUP OF EQUIPMENT UNDER TEST

5.1. DESCRIPTION OF SUPPORT UNITS

The EUT has been tested as an independent unit together with other necessary accessories or support units. The following support units or accessories were used to form a representative test configuration during the tests.

Peripherals Devices:

No.	Product	Manufacturer	Model No.	Certify No.	Signal cable
1	R-Load	N/A	44.77Ω	DOC	For Model: ERM00CC18-HS 、 ERM00CC110-HS
1	R-Load	N/A	2.5Ω	DOC	For Model: ERM02A18-HS 、 ERM02A110-HS
1	R-Load	N/A	88.93Ω	DOC	For Model: ERM01CC18-HS 、 ERM01CC110-HS
1	R-Load	N/A	1.25Ω	DOC	For Model: ERM04A18-HS 、 ERM04A110-HS

No.	Signal cable description	
A	DC IN cable	Unshielded, 0.3m, 2pcs.
B	DC OUT cable	Unshielded, 0.15m, 2pcs.

Note:

1. All the equipment/cables were placed in the worst-case configuration to maximize the emission during the test.
2. Grounding was established in accordance with the manufacturer's requirements and conditions for the intended use.

5.2. CONFIGURATION OF SYSTEM UNDER TEST

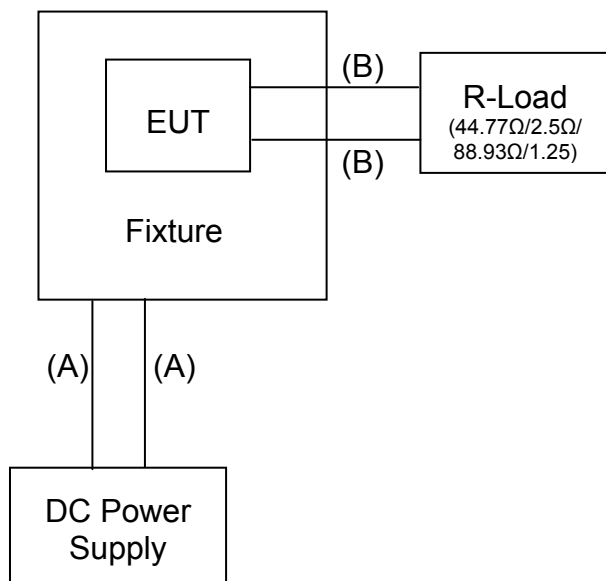

6 FACILITIES AND ACCREDITATIONS

6.1. FACILITIES

All measurement facilities used to collect the measurement data are located at CCS Taiwan Tainan Lab. and Xindian Lab. at

- No.8, Jiucengling, Xinhua Dist., Tainan City 712, Taiwan (R.O.C.)
- Xindian Lab. at No.163-1, Jhongsheng Rd., Xindian Dist., New Taipei City, 23151 Taiwan.

The sites are constructed in conformance with the requirements of ANSI C63.4 and CISPR Publication 22. All receiving equipment conforms to CISPR 16-1-1, CISPR 16-1-2, CISPR 16-1-3, CISPR 16-1-4 and CISPR 16-1-5.

6.2. ACCREDITATIONS

Our laboratories are accredited and approved by the following accreditation body according to ISO/IEC 17025.

Taiwan	TAF
---------------	-----

The measuring facility of laboratories has been authorized or registered by the following approval agencies.

Canada	Industry Canada
Germany	TUV NORD
Taiwan	BSMI
USA	FCC

Copies of granted accreditation certificates are available for downloading from our web site, <http://www.ccsrf.com>

6.3. MEASUREMENT UNCERTAINTY

Where relevant, the following measurement uncertainty levels have been estimated for tests performed on the EUT as specified in CISPR 16-4-2:

Measurement		Frequency	Uncertainty
Power Line Conducted Emission		9kHz~30MHz	±1.39dB
Conduction Emission	ISN	150kHz~30MHz	±2.56dB
	T-ISN	150kHz~30MHz	±2.56dB
Radiated Emission (10m)	Test Site : OATS-5	30 MHz ~200 MHz	±4.04dB
		200 MHz ~1000 MHz	±3.78dB
	Test Site : OATS-6	30 MHz ~200 MHz	±3.27dB
		200 MHz ~1000 MHz	±2.68dB
	Test Site : OATS-7	30 MHz ~200 MHz	±3.56dB
		200 MHz ~1000 MHz	±3.25dB
Radiated Emission (3m)	Test Site : OATS-5	30 MHz ~200 MHz	±3.45dB
		200 MHz ~1000 MHz	±2.55dB
	Test Site : OATS-6	30 MHz ~200 MHz	±3.55dB
		200 MHz ~1000 MHz	±2.35dB
	Test Site : OATS-7	30 MHz ~200 MHz	±3.55dB
		200 MHz ~1000 MHz	±2.33dB

This uncertainty represents an expanded uncertainty expressed at approximately the 95% confidence level using a coverage factor of k=2.

Consistent with industry standard (e.g. CISPR 22: 2008+I3: 2012, clause 11, Measurement Uncertainty) determining compliance with the limits shall be based on the results of the compliance measurement. Consequently the measured emissions being less than the maximum allowed emission result in this being a compliant test or passing test.

The acceptable measurement uncertainty value without requiring revision of the compliance statement is based on conducted and radiated emissions being less than U_{CISPR} which is 3.6dB and 5.2dB respectively. CCS values (called U_{Lab} in CISPR 16-4-2) is less than U_{CISPR} as shown in the table above. Therefore, MU need not be considered for compliance.

7 EMISSION TEST

7.1. CONDUCTED EMISSION MEASUREMENT

7.1.1. LIMITS

FREQUENCY (MHz)	Class A (dBuV)		Class B (dBuV)	
	Quasi-peak	Average	Quasi-peak	Average
0.15 - 0.5	79	66	66 - 56	56 - 46
0.50 - 5.0	73	60	56	46
5.0 - 30.0	73	60	60	50

Note:

1. The lower limit shall apply at the transition frequencies.
2. The limit decreases in line with the logarithm of the frequency in the range of 0.15 to 0.50 MHz.
3. All emanations from a class A/B digital device or system, including any network of conductors and apparatus connected thereto, shall not exceed the level of field strengths specified above.

7.1.2. TEST INSTRUMENTS

Conducted Emission room #1				
Name of Equipment	Manufacturer	Model	Serial Number	Calibration Due
BNC Coaxial Cable	CCS	BNC50	11	12/04/2016
EMI Test Receiver	R&S	ESCS 30	100348	12/03/2016
LISN	SCHWARZBECK	NNLK8130	8130124	10/27/2016
LISN	Schwarzbeck	NSLK 8127	8127526	08/23/2016
Pulse Limiter	R&S	ESH3-Z2	100116	12/04/2016
Software	e-3 (5.04211j)			

Note: The calibration interval of the above test instruments is 12 months and the calibrations are traceable to NML/ROC and NIST/USA.

7.1.3. TEST PROCEDURES

Procedure of Preliminary Test

The EUT and Support equipment, if needed, was set up as per the test configuration to simulate typical usage per the user's manual. When the EUT is a tabletop system, a wooden table with a height of 0.8 meters is used and is placed on the ground plane as per EN 55032 (see Test Facility for the dimensions of the ground plane used). When the EUT is a floor standing equipment, it is placed on the ground plane, which has a 15 cm non-conductive covering to insulate the EUT from the ground plane.

All I/O cables were positioned to simulate typical actual usage as per EN 55032.

The test equipment EUT installed received main power, through a Line Impedance Stabilization Network (LISN), which supplied power source and was grounded to the ground plane.

All support equipment power received from a second LISN.

The EUT test program was started. Emissions were measured on each current carrying line of the EUT using an EMI Test Receiver connected to the LISN powering the EUT.

The Receiver scanned from 150kHz to 30MHz for emissions in each of the test modes.

During the above scans, the emissions were maximized by cable manipulation.

The test mode(s) described in Item 4.1 were scanned during the preliminary test.

After the preliminary scan, we found the test mode described in Item 4.1 producing the highest emission level.

The EUT configuration and cable configuration of the above highest emission levels were recorded for reference of the final test.

Procedure of Final Test

EUT and support equipment were set up on the test bench as per the configuration with highest emission level in the preliminary test.

A scan was taken on both power lines, Line 1 and Line 2, recording at least the six highest emissions. Emission frequency and amplitude were recorded into a computer in which correction factors were used to calculate the emission level and compare reading to the applicable limit.

The test data of the worst-case condition(s) was recorded.

7.1.4. TEST SETUP

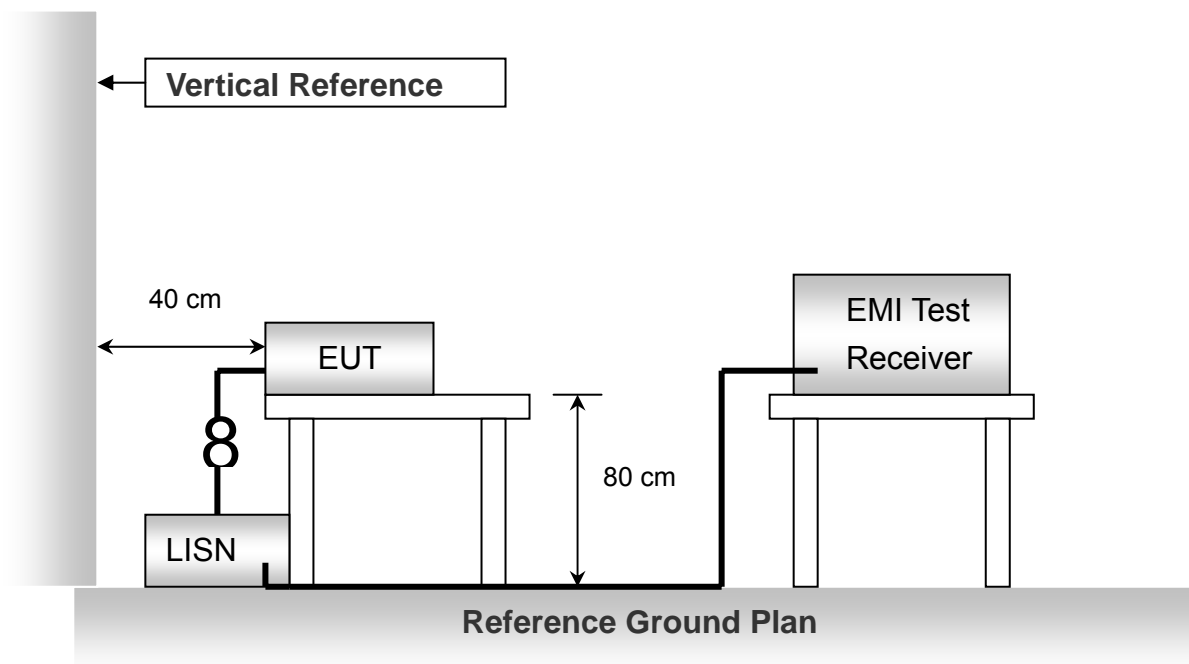

For the actual test configuration, please refer to the related item – Photographs of the Test Configuration.

7.1.5. DATA SAMPLE

Freq. (MHz)	LISN Factor (dB)	Cable Loss (dB)	Meter Reading (dBuV)	Measured Level (dBuV)	Limits (dBuV)	Over Limits (dBuV)	Detector
x.xx	9.6	0.1	15.7	25.4	46	-20.6	QP

- Freq. = Emission frequency in MHz
- LISN Factor = Insertion loss of LISN and Pulse Limiter
- Cable Loss = Insertion loss of Cable (LISN to EMI Tester Receiver)
- Meter Reading = Uncorrected Analyzer/Receiver reading
- Measured Level = Read Level + Factor
- Limit = Limit stated in standard
- Over Limit = Reading in reference to limit
- Peak = Peak Reading
- QP = Quasi-peak Reading
- AV = Average Reading

Calculation Formula

1. Measured Level (dBuV) = LISN Factor (dB) + Cable Loss (dB)+ Meter Reading (dBuV)
2. Over Limit (dBuV) = Measured Level (dBuV) – Limits (dBuV)

7.1.6. TEST RESULTS

Model No.	ERM00CC18-HS	Test Mode	Full Load
Environmental Conditions	26°C, 56% RH	Resolution Bandwidth	9 kHz
Tested by	Peter Chu		

LINE

(The chart below shows the highest readings taken from the final data.)

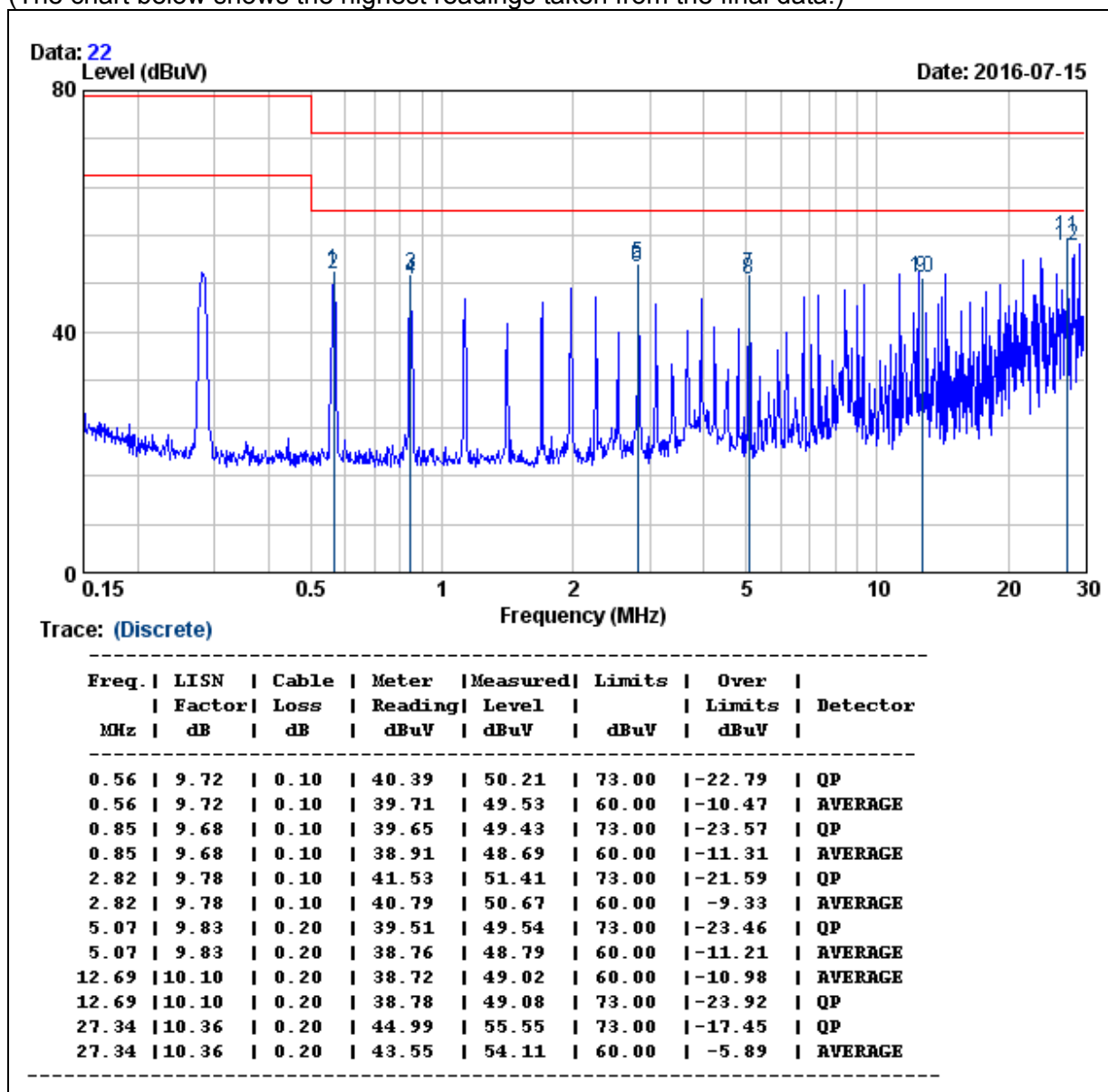

Note: 1. Level (dBUV) = Read Level (dBUV) + LISN Factor (dB) + Cable Loss (dB)
2. Over Limit value (dB) = Level (dBUV) – Limit Line (dBUV)

Model No.	ERM00CC18-HS	Test Mode	Full Load
Environmental Conditions	26°C, 56% RH	Resolution Bandwidth	9 kHz
Tested by	Peter Chu		

NEUTRAL

(The chart below shows the highest readings taken from the final data.)

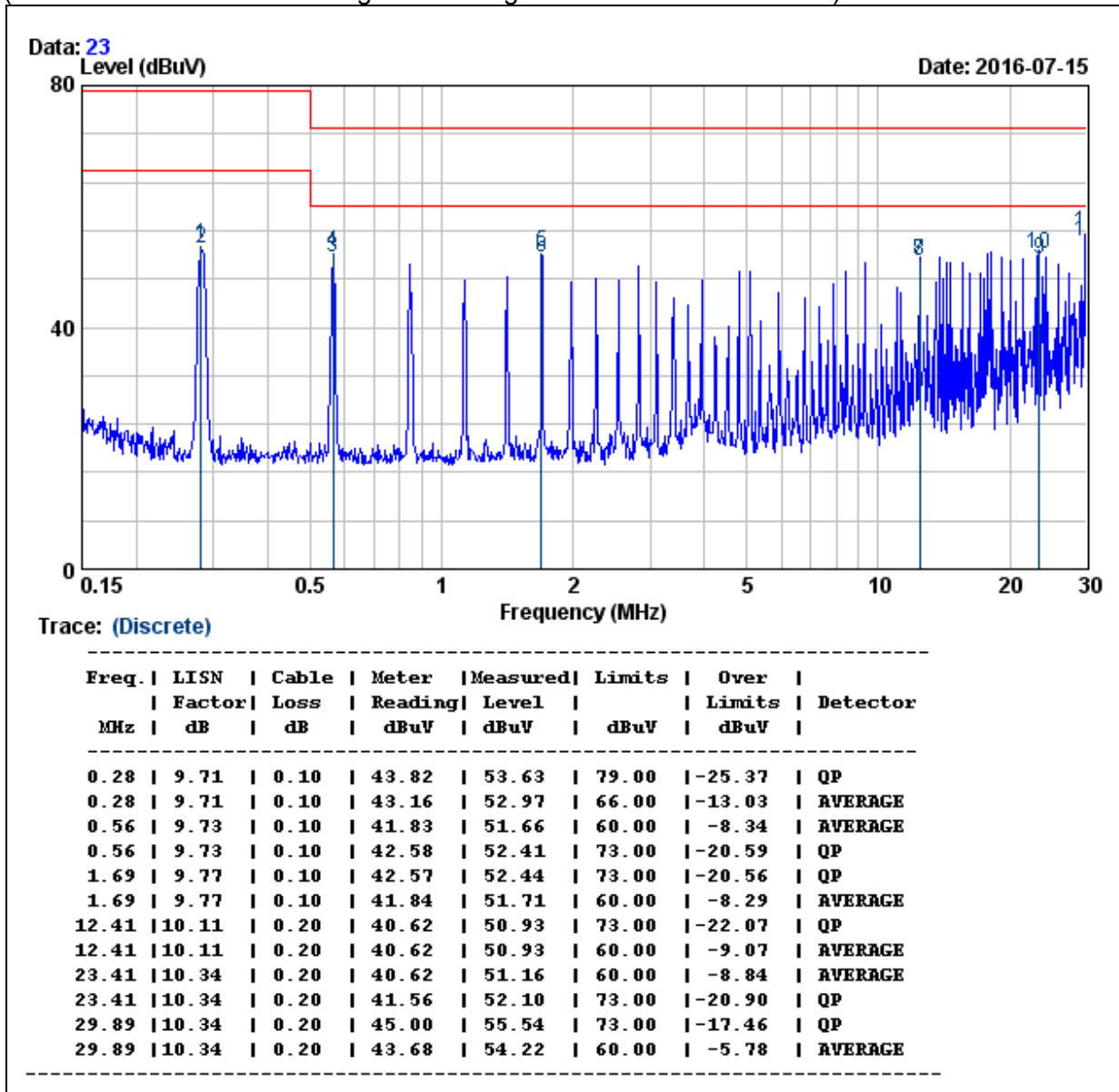

Note: 1. Level (dBUV) = Read Level (dBUV) + LISN Factor (dB) + Cable Loss (dB)
2. Over Limit value (dB) = Level (dBUV) – Limit Line (dBUV)

Model No.	ERM02A18-HS	Test Mode	Full Load
Environmental Conditions	26°C, 56% RH	Resolution Bandwidth	9 kHz
Tested by	Peter Chu		

LINE

(The chart below shows the highest readings taken from the final data.)

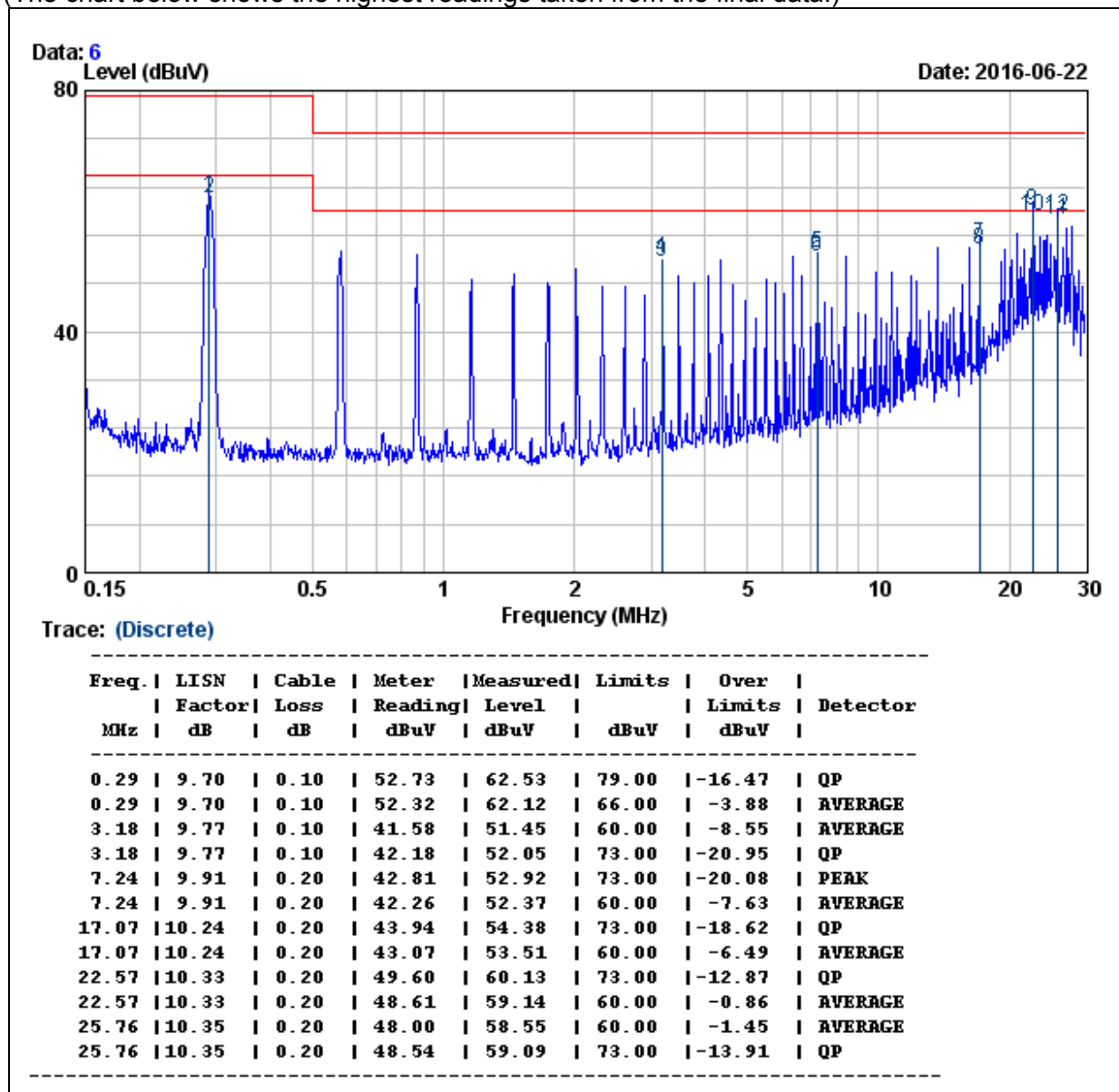

Note: 1. Level (dBUV) = Read Level (dBUV) + LISN Factor (dB) + Cable Loss (dB)
2. Over Limit value (dB) = Level (dBUV) – Limit Line (dBUV)

Model No.	ERM02A18-HS	Test Mode	Full Load
Environmental Conditions	26°C, 56% RH	Resolution Bandwidth	9 kHz
Tested by:	Peter Chu		

NEUTRAL

(The chart below shows the highest readings taken from the final data.)

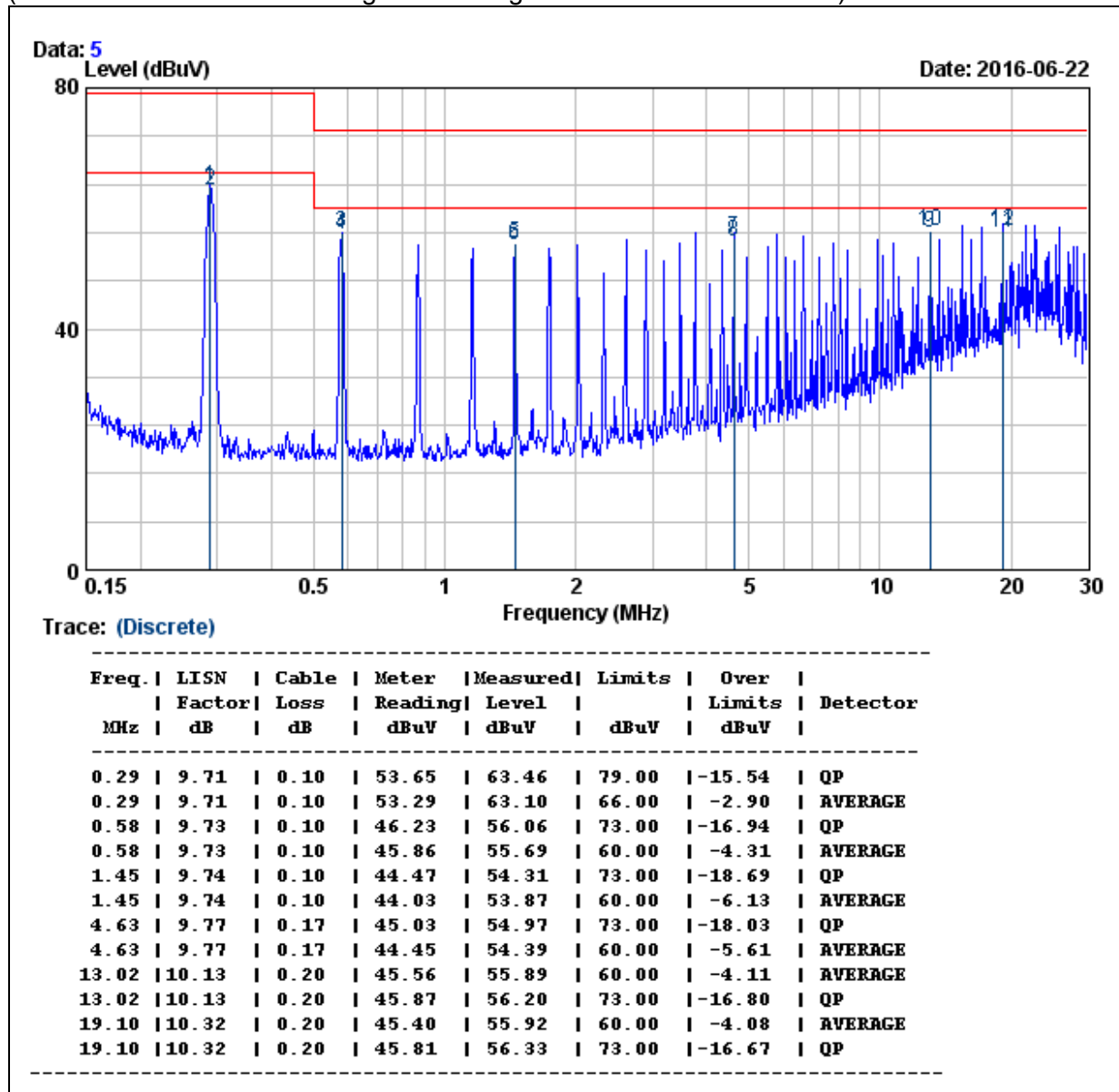

Note: 1. Level (dBUV) = Read Level (dBUV) + LISN Factor (dB) + Cable Loss (dB)
2. Over Limit value (dB) = Level (dBUV) – Limit Line (dBUV)

Model No.	ERM00CC110-HS	Test Mode	Full Load
Environmental Conditions	26°C, 56% RH	Resolution Bandwidth	9 kHz
Tested by	Peter Chu		

LINE

(The chart below shows the highest readings taken from the final data.)

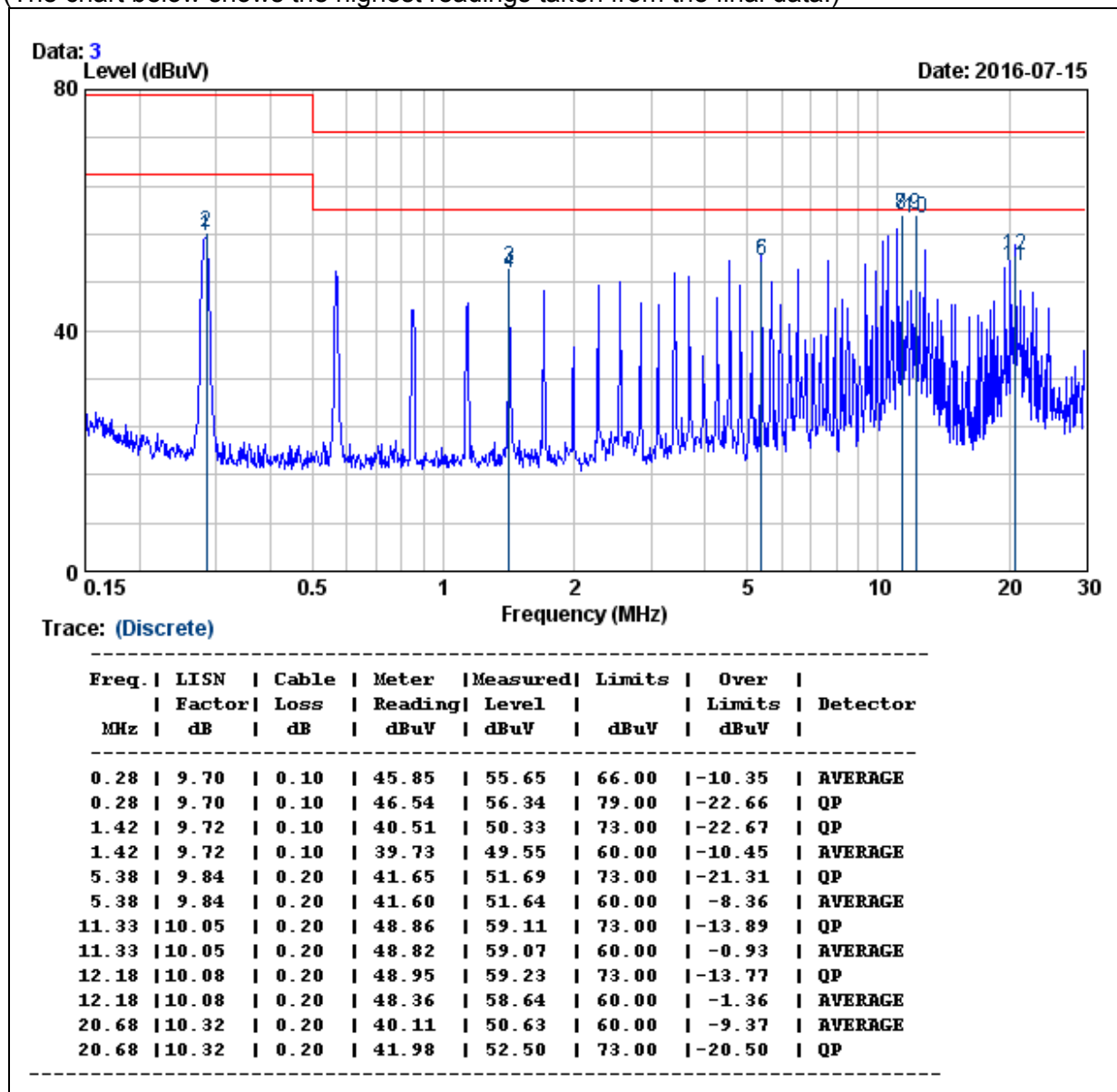

- Note: 1. Level (dBUV) = Read Level (dBUV) + LISN Factor (dB) + Cable Loss (dB)
2. Over Limit value (dB) = Level (dBUV) – Limit Line (dBUV)

Model No.	ERM00CC110-HS	Test Mode	Full Load
Environmental Conditions	26°C, 56% RH	Resolution Bandwidth	9 kHz
Tested by:	Peter Chu		

NEUTRAL

(The chart below shows the highest readings taken from the final data.)

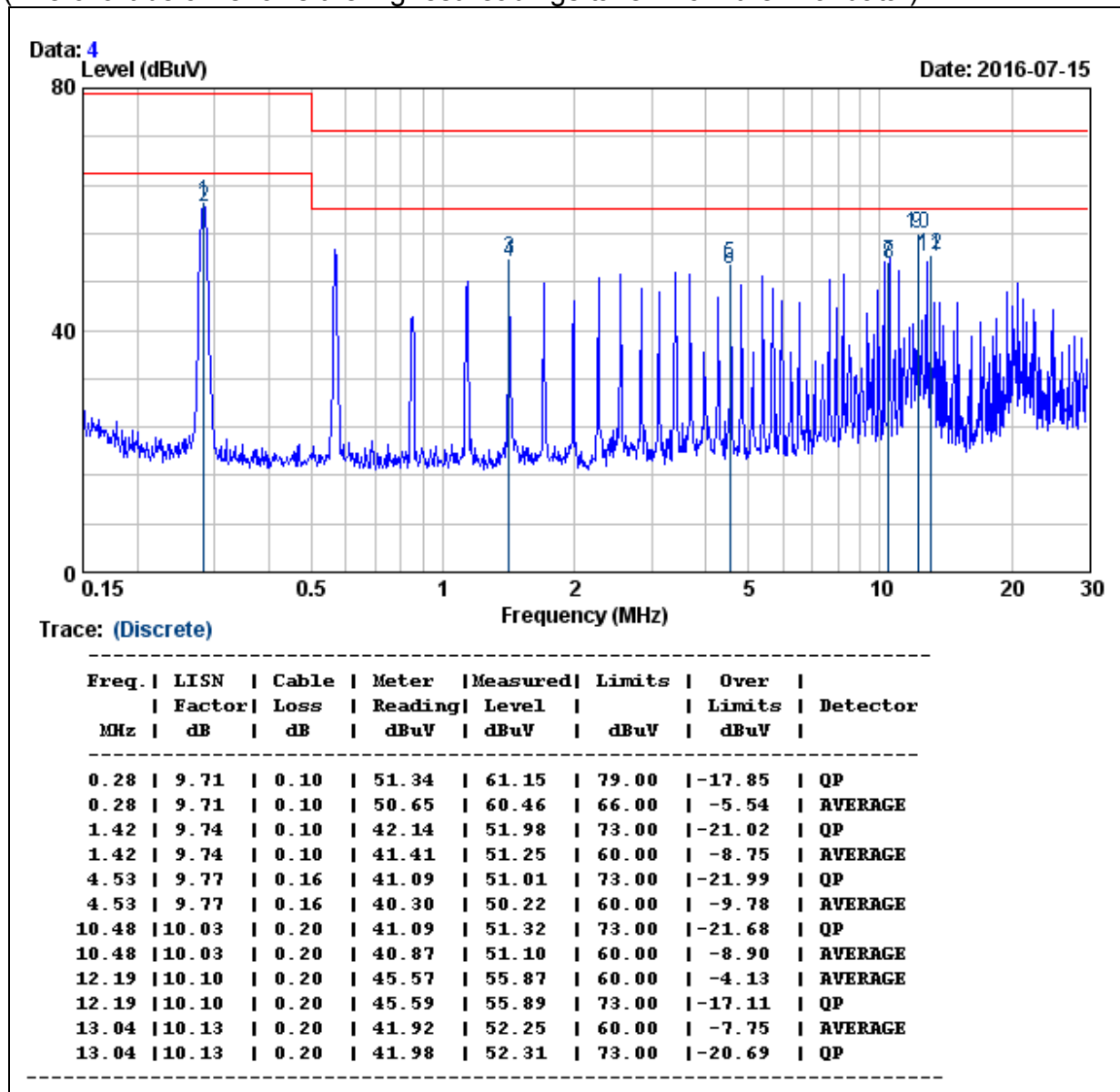

Note: 1. Level (dBuV) = Read Level (dBuV) + LISN Factor (dB) + Cable Loss (dB)
2. Over Limit value (dB) = Level (dBuV) – Limit Line (dBuV)

Model No.	ERM02A110-HS	Test Mode	Full Load
Environmental Conditions	26°C, 56% RH	Resolution Bandwidth	9 kHz
Tested by	Peter Chu		

LINE

(The chart below shows the highest readings taken from the final data.)

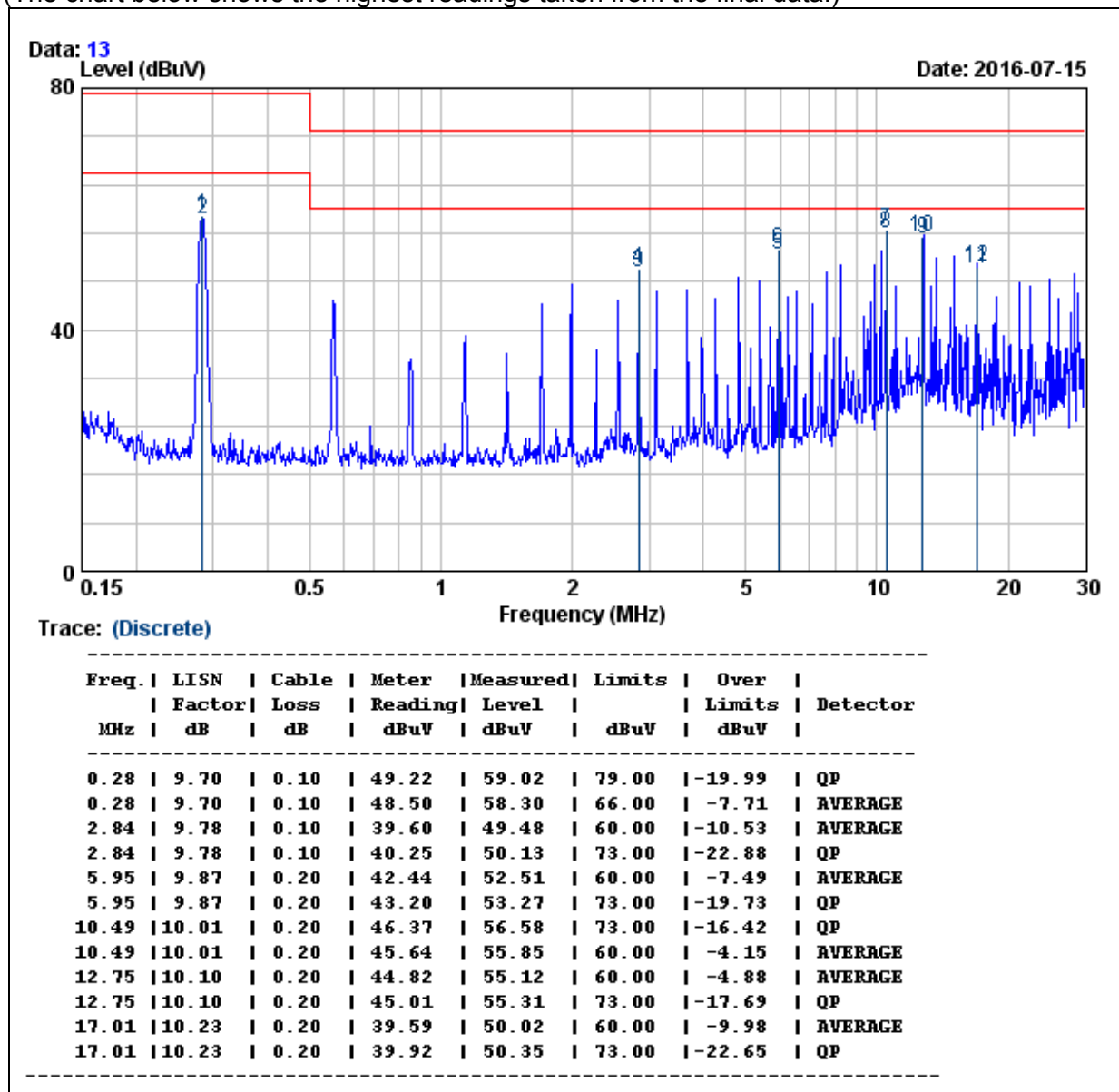

- Note: 1. Level (dBUV) = Read Level (dBUV) + LISN Factor (dB) + Cable Loss (dB)
2. Over Limit value (dB) = Level (dBUV) – Limit Line (dBUV)

Model No.	ERM02A110-HS	Test Mode	Full Load
Environmental Conditions	26°C, 56% RH	Resolution Bandwidth	9 kHz
Tested by:	Peter Chu		

NEUTRAL

(The chart below shows the highest readings taken from the final data.)

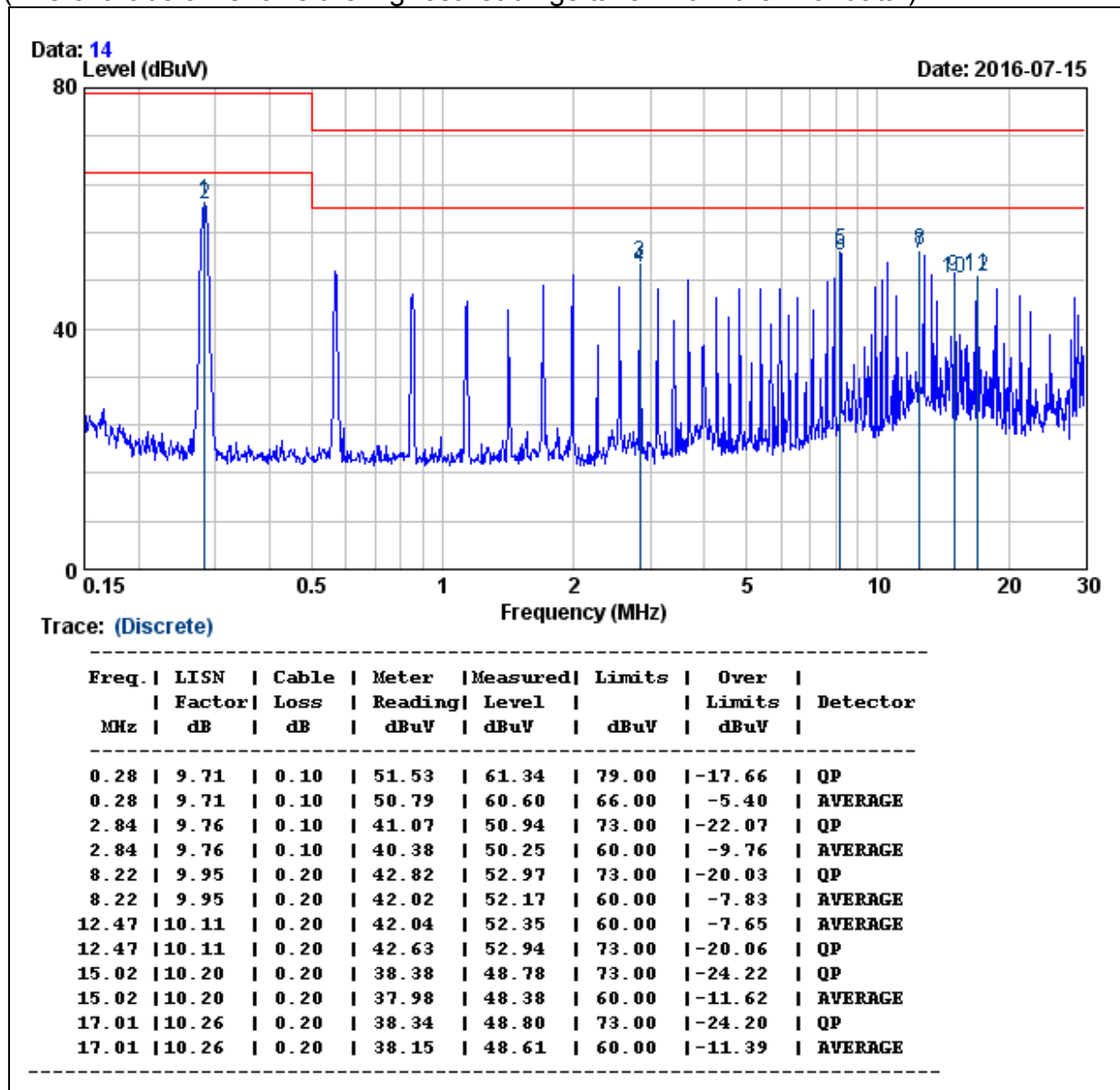

Note: 1. Level (dBUV) = Read Level (dBUV) + LISN Factor (dB) + Cable Loss (dB)
2. Over Limit value (dB) = Level (dBUV) – Limit Line (dBUV)

Model No.	ERM01CC18-HS	Test Mode	Full Load
Environmental Conditions	26°C, 56% RH	Resolution Bandwidth	9 kHz
Tested by	Peter Chu		

LINE

(The chart below shows the highest readings taken from the final data.)

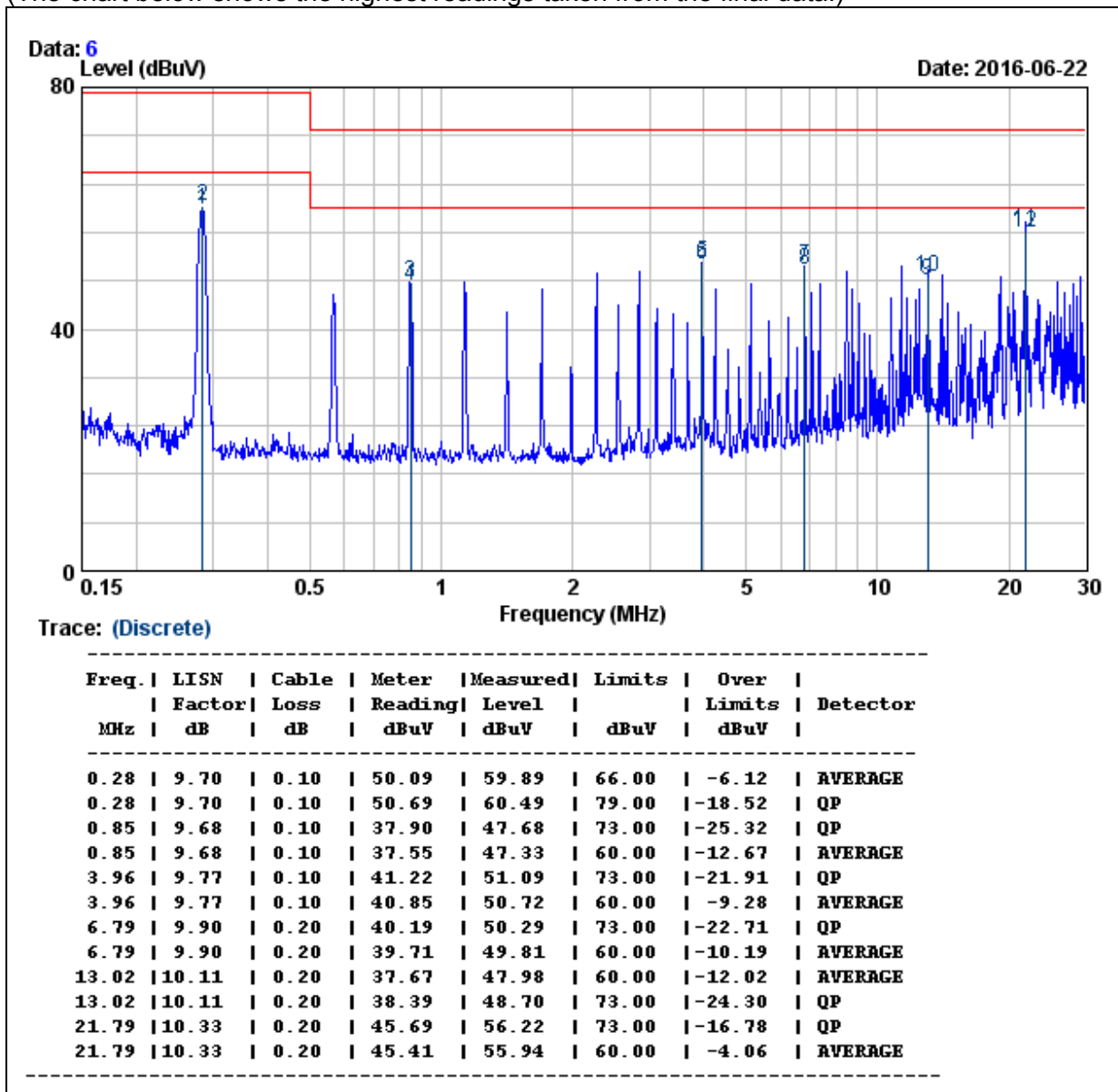

Note: 1. Level (dBuV) = Read Level (dBuV) + LISN Factor (dB) + Cable Loss (dB)
2. Over Limit value (dB) = Level (dBuV) – Limit Line (dBuV)

Model No.	ERM01CC18-HS	Test Mode	Full Load
Environmental Conditions	26°C, 56% RH	Resolution Bandwidth	9 kHz
Tested by	Peter Chu		

NEUTRAL

(The chart below shows the highest readings taken from the final data.)

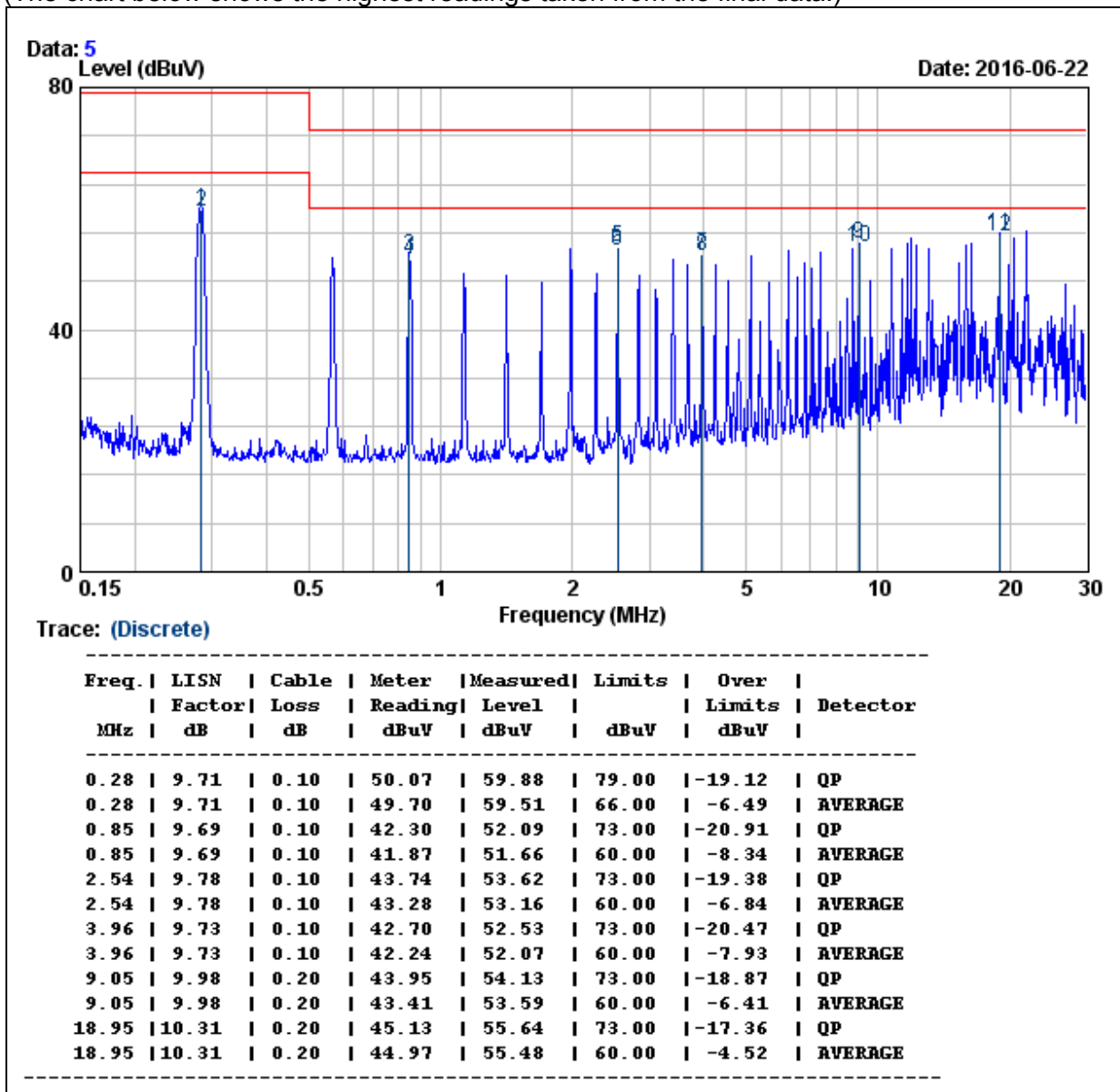

Note: 1. Level (dBUV) = Read Level (dBUV) + LISN Factor (dB) + Cable Loss (dB)
2. Over Limit value (dB) = Level (dBUV) – Limit Line (dBUV)

Model No.	ERM04A18-HS	Test Mode	Full Load
Environmental Conditions	26°C, 56% RH	Resolution Bandwidth	9 kHz
Tested by	Peter Chu		

LINE

(The chart below shows the highest readings taken from the final data.)

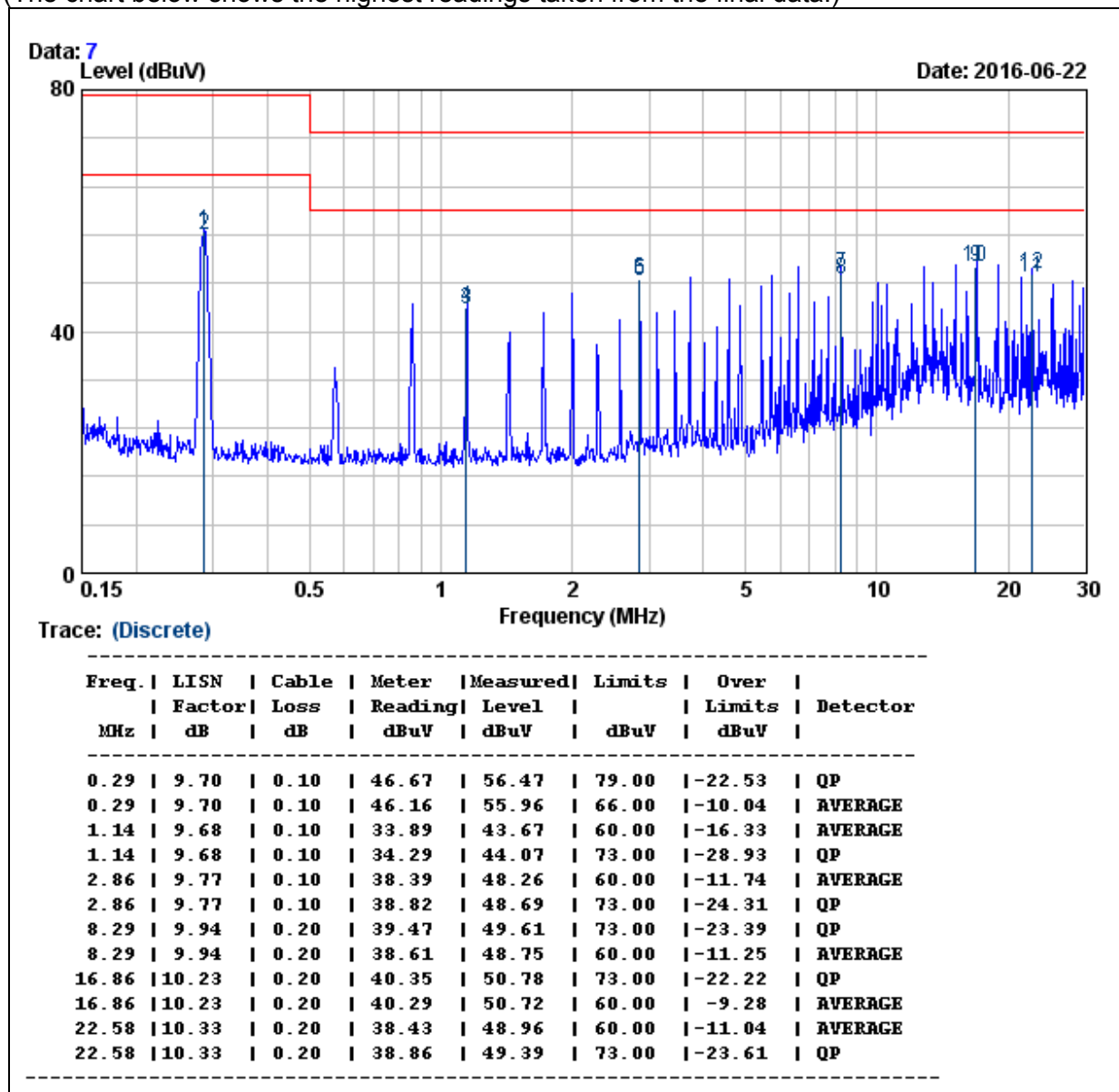

Note: 1. Level (dBuV) = Read Level (dBuV) + LISN Factor (dB) + Cable Loss (dB)
2. Over Limit value (dB) = Level (dBuV) – Limit Line (dBuV)

Model No.	ERM04A18-HS	Test Mode	Full Load
Environmental Conditions	26°C, 56% RH	Resolution Bandwidth	9 kHz
Tested by:	Peter Chu		

NEUTRAL

(The chart below shows the highest readings taken from the final data.)

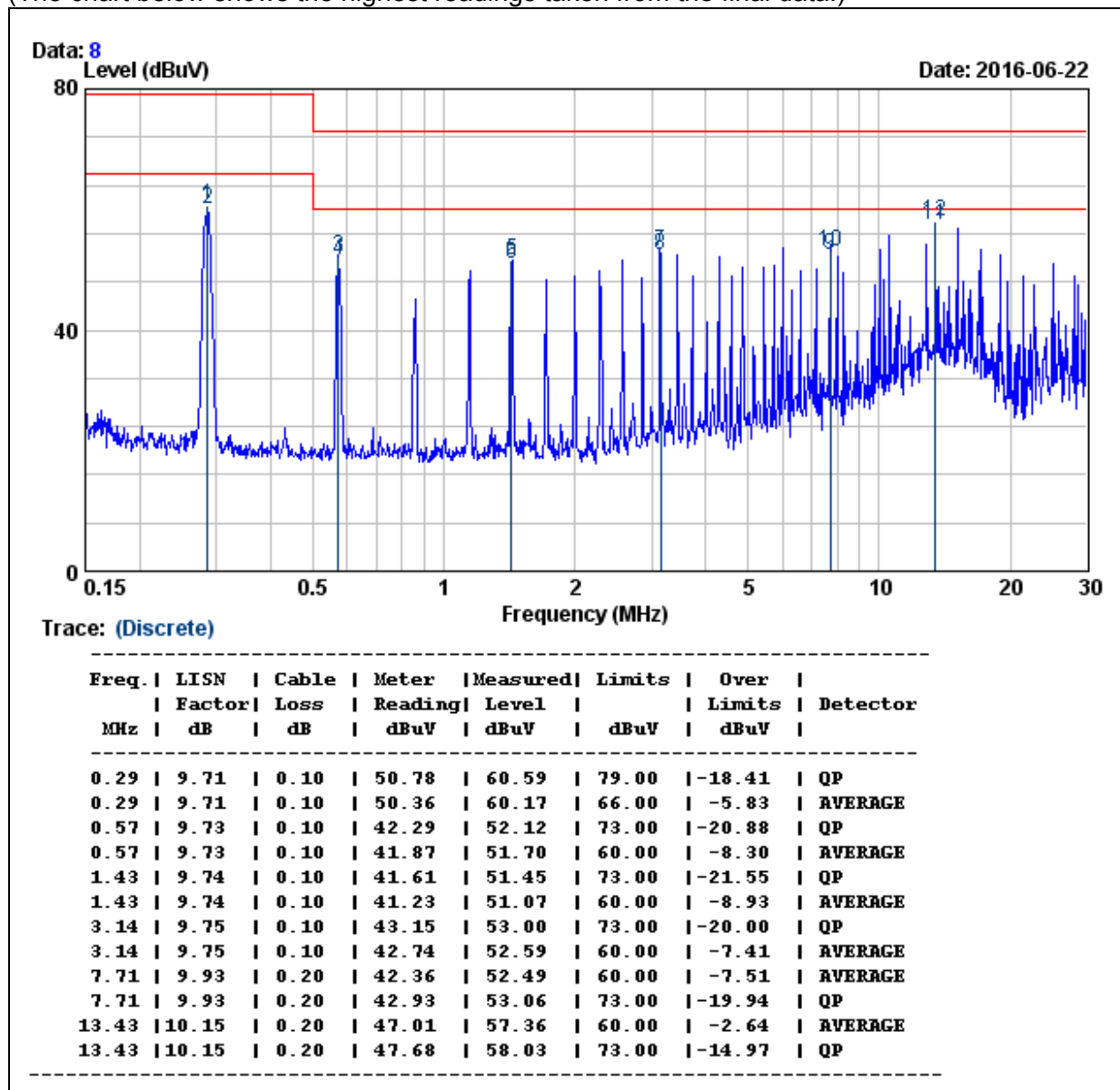

Note: 1. Level (dBUV) = Read Level (dBUV) + LISN Factor (dB) + Cable Loss (dB)
2. Over Limit value (dB) = Level (dBUV) – Limit Line (dBUV)

Model No.	ERM01CC110-HS	Test Mode	Full Load
Environmental Conditions	26°C, 56% RH	Resolution Bandwidth	9 kHz
Tested by	Peter Chu		

LINE

(The chart below shows the highest readings taken from the final data.)

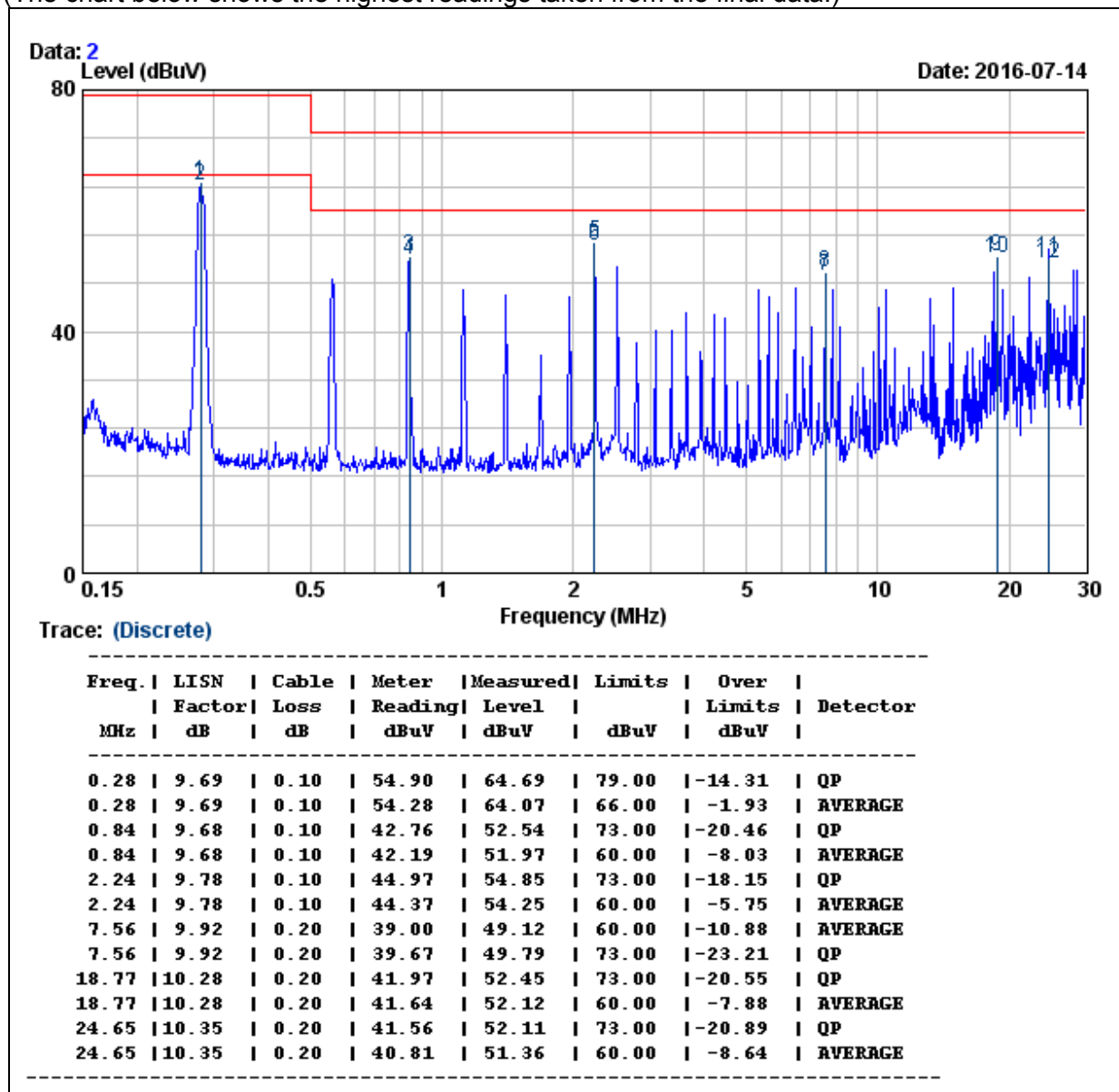

- Note: 1. Level (dBuV) = Read Level (dBuV) + LISN Factor (dB) + Cable Loss (dB)
2. Over Limit value (dB) = Level (dBuV) – Limit Line (dBuV)

Model No.	ERM01CC110-HS	Test Mode	Full Load
Environmental Conditions	26°C, 56% RH	Resolution Bandwidth	9 kHz
Tested by:	Peter Chu		

NEUTRAL

(The chart below shows the highest readings taken from the final data.)

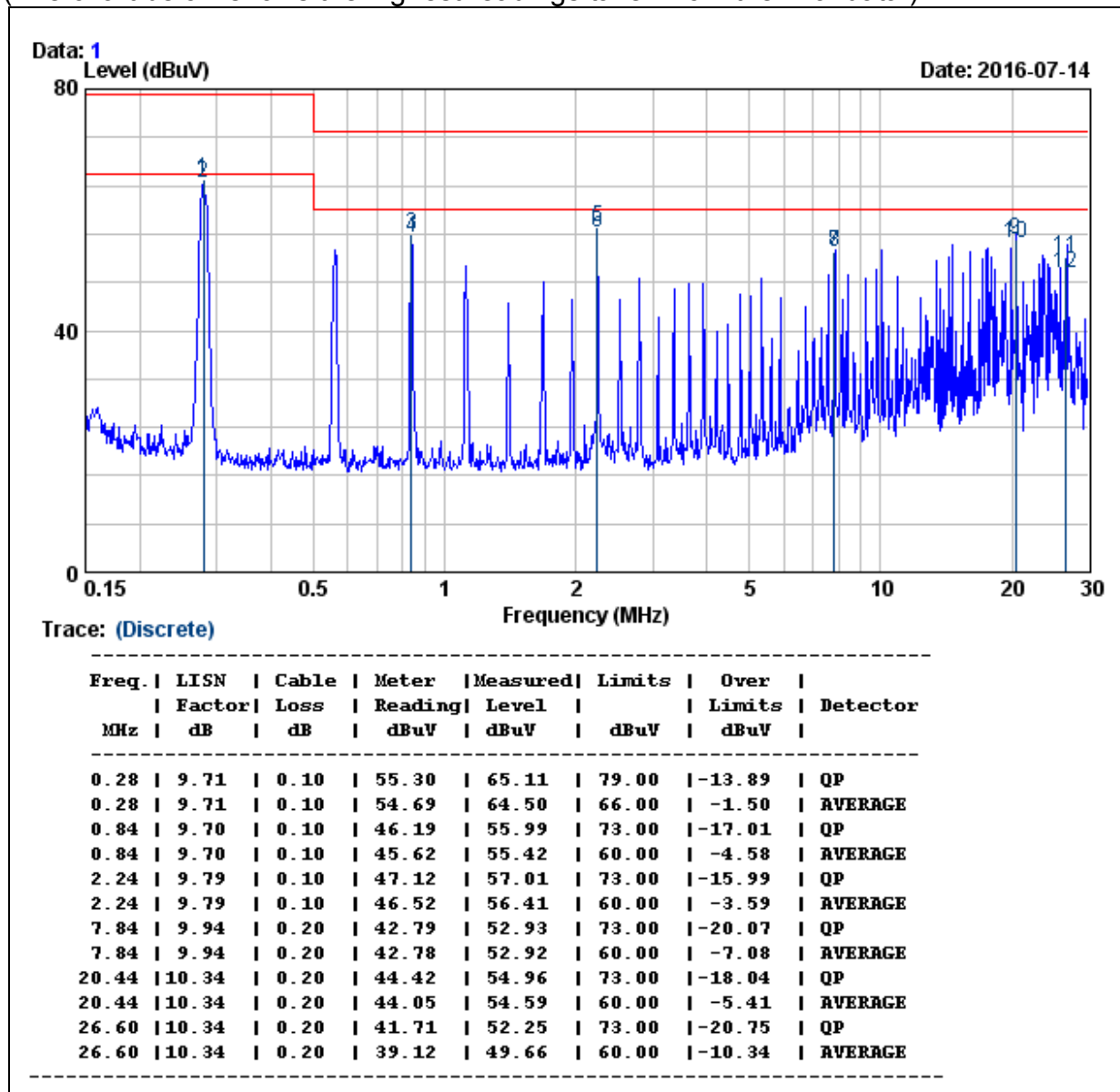

Note: 1. Level (dBuV) = Read Level (dBuV) + LISN Factor (dB) + Cable Loss (dB)
2. Over Limit value (dB) = Level (dBuV) – Limit Line (dBuV)

Model No.	ERM04A110-HS	Test Mode	Full Load
Environmental Conditions	26°C, 56% RH	Resolution Bandwidth	9 kHz
Tested by	Peter Chu		

LINE

(The chart below shows the highest readings taken from the final data.)

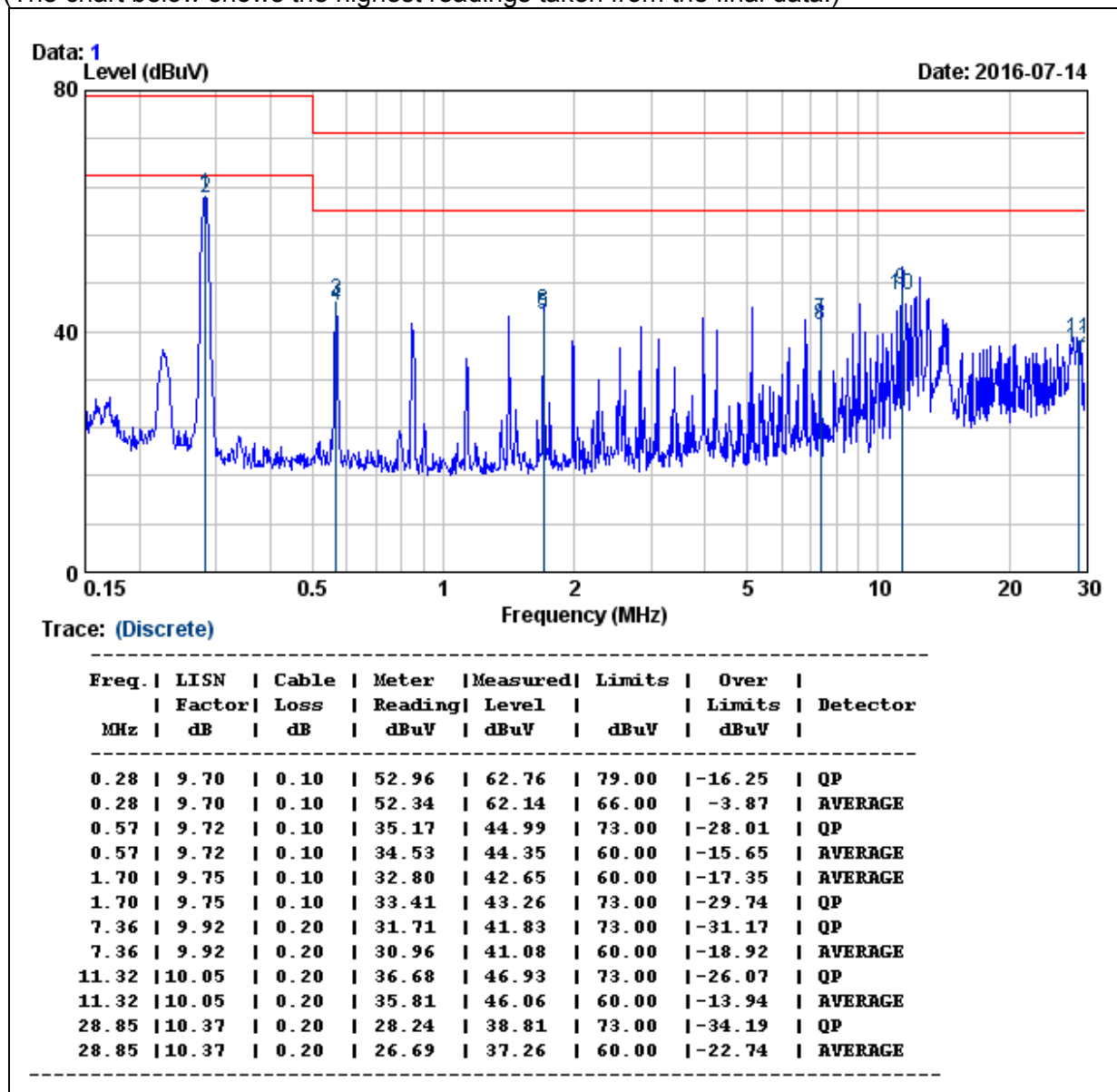

- Note:
- Level (dBUV) = Read Level (dBUV) + LISN Factor (dB) + Cable Loss (dB)
 - Over Limit value (dB) = Level (dBUV) – Limit Line (dBUV)

Model No.	ERM04A110-HS	Test Mode	Full Load
Environmental Conditions	26°C, 56% RH	Resolution Bandwidth	9 kHz
Tested by:	Peter Chu		

NEUTRAL

(The chart below shows the highest readings taken from the final data.)

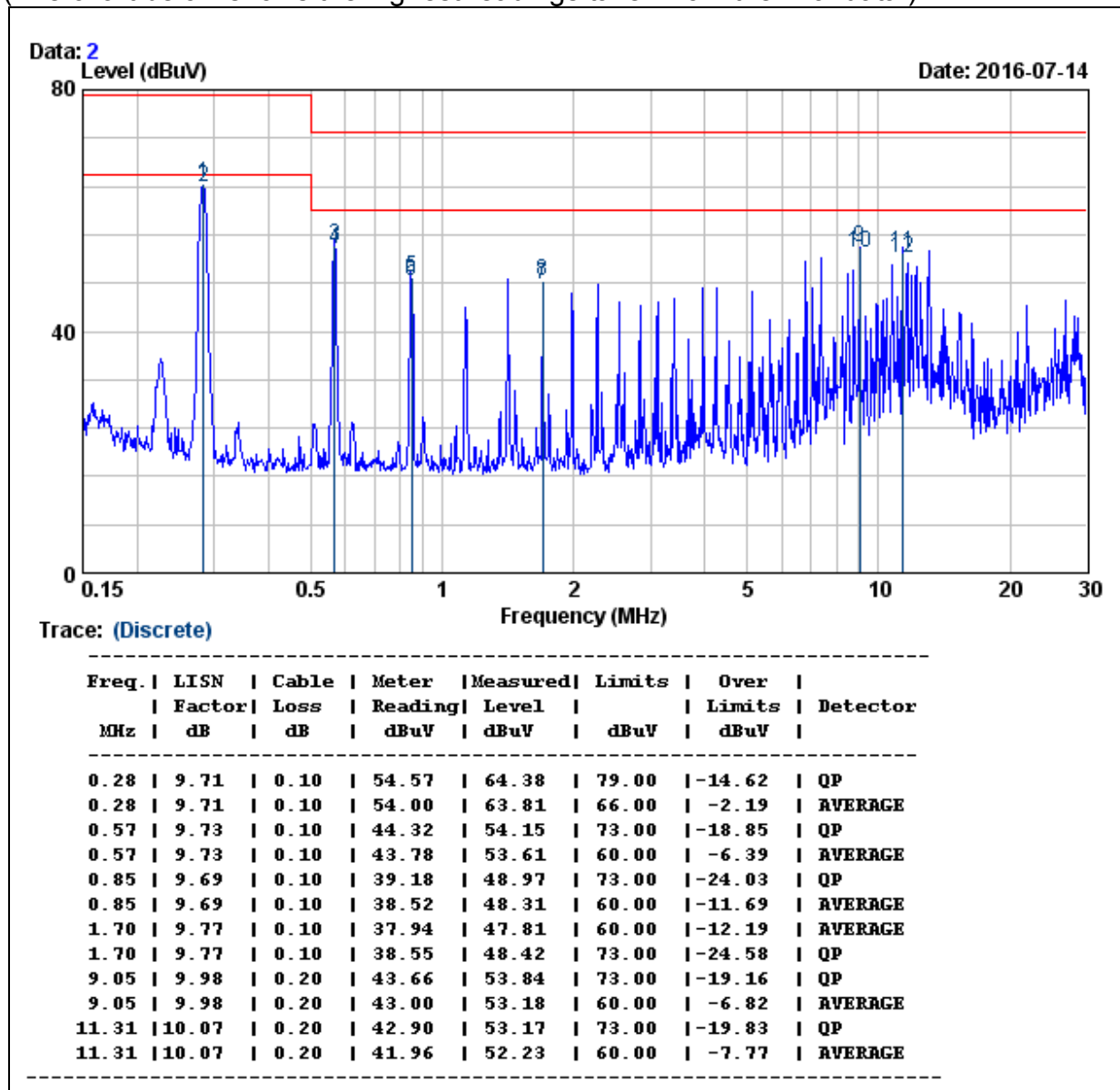

Note: 1. Level (dBUV) = Read Level (dBUV) + LISN Factor (dB) + Cable Loss (dB)
2. Over Limit value (dB) = Level (dBUV) – Limit Line (dBUV)

7.2. CONDUCTED EMISSION MEASUREMENT AT ANALOGUE/DIGITAL DATA PORTS

7.2.1. LIMITS

For Class A Equipment

FREQUENCY (MHz)	Voltage Limit (dBuV)		Current Limit (dBuA)	
	Quasi-peak	Average	Quasi-peak	Average
0.15 ~ 0.5	97 ~ 87	84 ~ 74	53 ~ 43	40 ~ 30
0.5 ~ 30.0	87	74	43	30

Note: The limits decrease linearly with the logarithm of the frequency in the range 0.15 MHz to 0.5 MHz.

For Class B Equipment

FREQUENCY (MHz)	Voltage Limit (dBuV)		Current Limit (dBuA)	
	Quasi-peak	Average	Quasi-peak	Average
0.15 - 0.5	84 ~ 74	74 ~ 64	40 ~ 30	30 ~ 20
0.5 - 30.0	74	64	30	20

Note: The limits decrease linearly with the logarithm of the frequency in the range 0.15 MHz to 0.5 MHz.

7.2.2. TEST INSTRUMENTS

Conducted Emission room # 1				
Name of Equipment	Manufacturer	Model	Serial Number	Calibration Due
BNC Coaxial Cable	CCS	BNC50	11	12/04/2016
EMI Test Receiver	R&S	ESCS 30	100348	12/03/2016
Four BALACED PAIR ISN	FCC	F-071115-1057-1-09	111130	11/08/2016
LISN	SCHWARZBECK	NNLK8130	8130124	10/27/2016
LISN	Schwarzbeck	NSLK 8127	8127526	08/23/2016
Pulse Limiter	R&S	ESH3-Z2	100116	12/04/2016
Software	e-3 (5.04211j)			

Note:

1. The calibration interval of the above test instruments is 12 months and the calibrations are traceable to NML/ROC and NIST/USA.
2. N.C.R = No Calibration Request.

7.2.3. TEST PROCEDURE

Selecting ISN for unscreened cable or a current probe for screened cable to take measurement.

The port of the EUT was connected to the remote side support equipment through the ISN/Current Probe and communication in normal condition.

Making a overall range scan by using the test receiver controlled by controller and record at least six highest emissions for showing in the test report.

Emission frequency and amplitude were recorded into a computer in which correction factors were used to calculate the emission level and compare reading to the applicable limit.

In case of measuring on the screened cable, the current limit shall be applied; otherwise the voltage limit should be applied.

The following test modes was scanned during the preliminary test:

N/A

After the preliminary scan, we found the following test mode(s) producing the highest emission level and test data of the worst case was recorded.

N/A

7.2.4. TEST SETUP

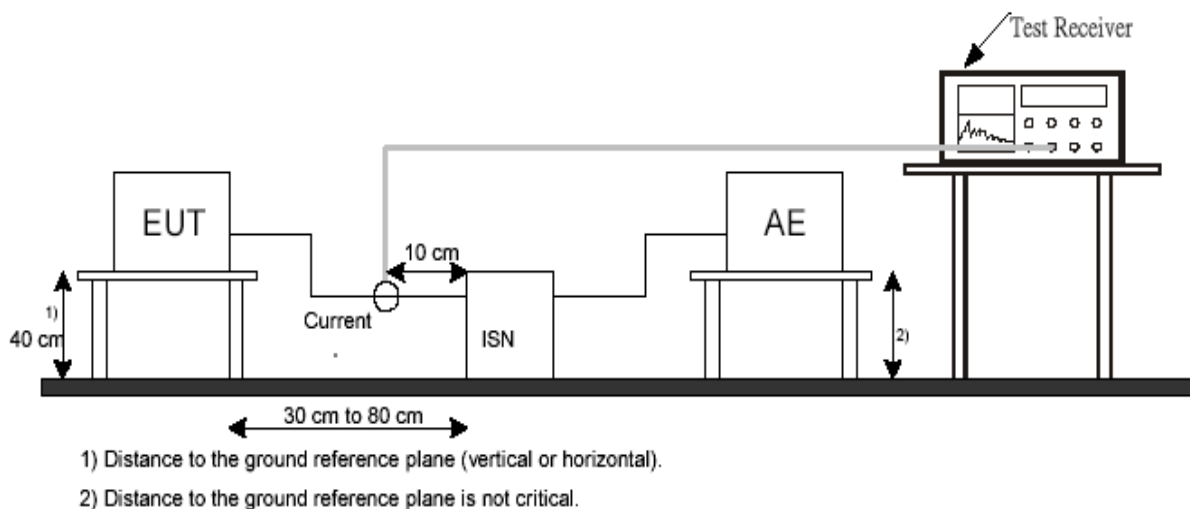

For the actual test configuration, please refer to the related item – Photographs of the Test Configuration.

7.2.5. DATA SAMPLE

Freq. (MHz)	LISN Factor (dB)	Cable Loss (dB)	Meter Reading (dBuV)	Measured Level (dBuV)	Limits (dBuV)	Over Limits (dBuV)	Detector
x.xx	9.71	0.02	37.17	46.9	66	-19.10	QP

- Freq. = Emission frequency in MHz
- LISN Factor = Insertion loss of ISN and Pulse Limiter
- Cable loss = Insertion loss of of Cable (ISN to EMI Tester Receiver)
- Meter Reading = Uncorrected Analyzer/Receiver reading
- Measured Level = Read Level + Factor
- Limit = Limit stated in standard
- Over Limit = Reading in reference to limit
- Peak = Peak Reading
- QP = Quasi-peak Reading
- AV = Average Reading

Calculation Formula

Over Limit (dB) = Level (dBuV) – Limit (dBuV)

7.2.6. TEST RESULTS

※Note: Not applicable, the EUT doesn't have LAN Port or Modem port.

7.3. RADIATED EMISSION MEASUREMENT

7.3.1. LIMITS

Below 1GHz

FREQUENCY (MHz)	dBuV/m (At 10m)	
	Class A	Class B
30 ~ 230	40	30
230 ~ 1000	47	37

Note: The lower limit shall apply at the transition frequencies.

Above 1GHz

FREQUENCY (MHz)	Class A (dBuV/m) (At 3m)		Class B (dBuV/m) (At 3m)	
	Average	Peak	Average	Peak
1000 ~ 3000	56	76	50	70
3000 ~ 6000	60	80	54	74

Note: The lower limit shall apply at the transition frequencies.

According to EN55032:2012+AC:2013, the measurement frequency range shown in the following table:

Highest frequency generated or used within the EUT or on which the EUT operates or tunes (MHz)	Upper frequency of measurement range (MHz)
Less than 108	1000
108-500	2000
500-1000	5000
Above 1000	5 times of the highest frequency or 6GHz, whichever is less

7.3.2. TEST INSTRUMENTS

Open Area Test Site # 5

Open Area Test Site # 5				
Name of Equipment	Manufacturer	Model	Serial Number	Calibration Due
Bi-Log Antenna	Sunol	JB1	A070506-1	01/24/2017
EMI Test Receiver	R&S	ESCI 7	100856	11/18/2016
Type N coaxial cable	Suhner	RG_214_U/2X	5	12/02/2016
Software	e3 (5.04211j)			

Open Area Test Site # 7

Open Area Test Site # 7				
Name of Equipment	Manufacturer	Model	Serial Number	Calibration Due
Bi-Log Antenna	Sunol	JB1	A013105-1	08/09/2016
EMI Test Receiver	R&S	ESCI	101336	03/21/2017
Type N coaxial cable	Suhner	RG_214_U/2X	7	12/02/2016
Software	e3 (5.04211j)			

Above 1GHz Used				
Name of Equipment	Manufacturer	Model	Serial Number	Calibration Due
EXA Spectrum Analyzer	KEYSIGHT	N9010A	MY54430216	04/29/2017
Horn Antenna	Com-Power	AH-118	071032	01/20/2017
Pre-Amplifier	EMCI	EMC012645	980098	01/17/2017

Note:

1. The calibration interval of the above test instruments is 12 months and the calibrations are traceable to NML/ROC and NIST/USA.
2. N.C.R. = No Calibration Request.

7.3.3. TEST PROCEDURE

Procedure of Preliminary Test

The equipment was set up as per the test configuration to simulate typical usage per the user's manual. When the EUT is a tabletop system, a wooden turntable with a height of 0.8 meters is used which is placed on the ground plane. When the EUT is a floor standing equipment, it is placed on the ground plane which has a 15 cm non-conductive covering to insulate the EUT from the ground plane.

Support equipment, if needed, was placed as per EN 55032.

All I/O cables were positioned to simulate typical usage as per EN 55032.

The EUT received power source from the outlet socket under the turntable. All support equipment power received from another socket under the turntable.

The antenna was placed at 10/3 meter away from the EUT as stated in EN 55032. The antenna connected to the Spectrum Analyzer via a cable and at times a pre-amplifier would be used.

The Analyzer / Receiver quickly scanned from 30MHz to 6000MHz. The EUT test program was started. Emissions were scanned and measured rotating the EUT to 360 degrees and positioning the antenna 1 to 4 meters above the ground plane, in both the vertical and the horizontal polarization, to maximize the emission reading level.

The test mode(s) described in Item 4.1 were scanned during the preliminary test:

After the preliminary scan, we found the test mode described in Item 4.1 producing the highest emission level.

The EUT and cable configuration, antenna position, polarization and turntable position of the above highest emission level were recorded for the final test.

Procedure of Final Test

EUT and support equipment were set up on the turntable as per the configuration with highest emission level in the preliminary test.

The Analyzer / Receiver scanned from 30MHz to 6000MHz. Emissions were scanned and measured rotating the EUT to 360 degrees, varying cable placement and positioning the antenna 1 to 4 meters above the ground plane, in both the vertical and the horizontal polarization, to maximize the emission reading level.

Recorded at least the six highest emissions. Emission frequency, amplitude, antenna position, polarization and turntable position were recorded into a computer in which correction factors were used to calculate the emission level and compare reading to the applicable limit and only Q.P. reading is presented.

The test data of the worst-case condition(s) was recorded.

7.3.4. TEST SETUP

Below 1 GHz

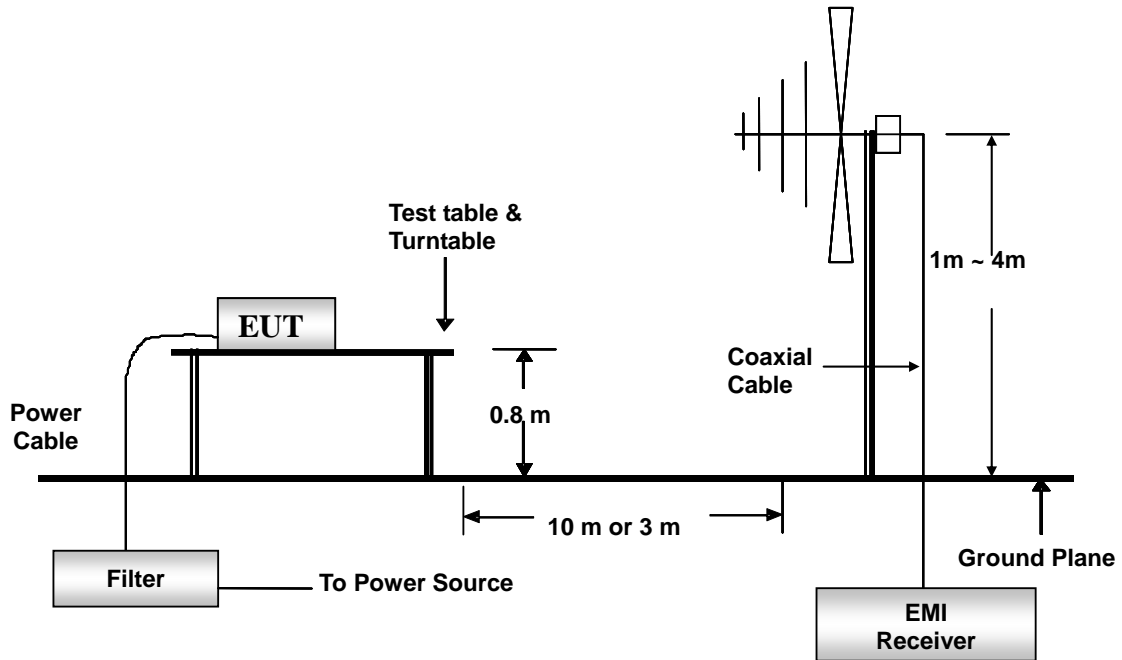

Above 1 GHz

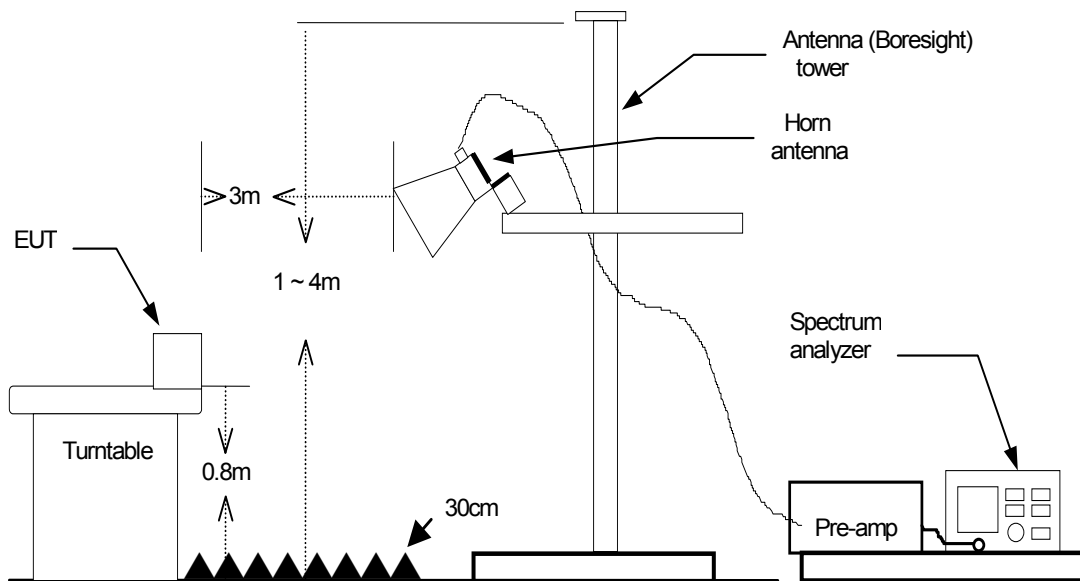

For the actual test configuration, please refer to the related item – Photographs of the Test Configuration.

7.3.5. DATA SAMPLE

Freq. (MHz)	Reading (dBuV/m)	Antenna Factor (dB)	Cable loss (dB)	Measure level (dBuV/m)	Limit (dBu/m)	Over limit (dBuV/m)	Detector
x.xx	24.48	7.33	1.50	33.31	40	-6.69	QP

- Freq. = Emission frequency in MHz
- Reading = Uncorrected Analyzer/Receiver reading
- Antenna Factor = Antenna Factor
- Cable loss = Insertion loss of cable
- Measure level = Reading + Factor
- Limit = Limit stated in standard
- Over limit = Measure level – Limit
- Peak = Peak Reading
- QP = Quasi-peak Reading
- AV = Average Reading

Calculation Formula

Over limit (dBuV/m) = Result (dBuV/m) – Limit (dBuV/m)

Above 1GHz

Freq. (MHz)	Reading (dBμV)	AF (dBμV)	C loss (dB)	Pre-amp (dB)	Filter (dB)	Level (dBμV/m)	Limit (dBμV/m)	Margin (dB)	Mark (P/Q/A)
XXXX. XX	56.00	25.14	2.07	41.77	0.72	42.16	70.00	-27.84	P

- Freq. = Emission frequency in MHz
- Reading = Uncorrected Analyzer/Receiver reading
- AF = Antenna Factor
- C loss = Insertion loss of cable
- Pre-amp = Pre-amplifier Gain
- Filter = Insertion loss of filter
- Level = Reading+AF+C loss-Pre-amp+Filter
- Limit = Limit stated in standard
- Margin = Reading in reference to limit
- Mark: P = Peak Reading
Q = Quasi-peak Reading
A = Average Reading

Calculation Formula

Margin (dB) =Level (dBuV/m) – Limit (dBuV/m)

7.3.6. TEST RESULTS

Below 1GHz

Model No.	ERM00CC18-HS	Test Mode	Full Load
Environmental Conditions	26.8°C, 54% RH	Resolution Bandwidth	120 kHz
Antenna Pole	Vertical	Antenna Distance	10m
Detector Function	Quasi-peak.	Tested by	Weici Lo

(The chart below shows the highest readings taken from the final data.)

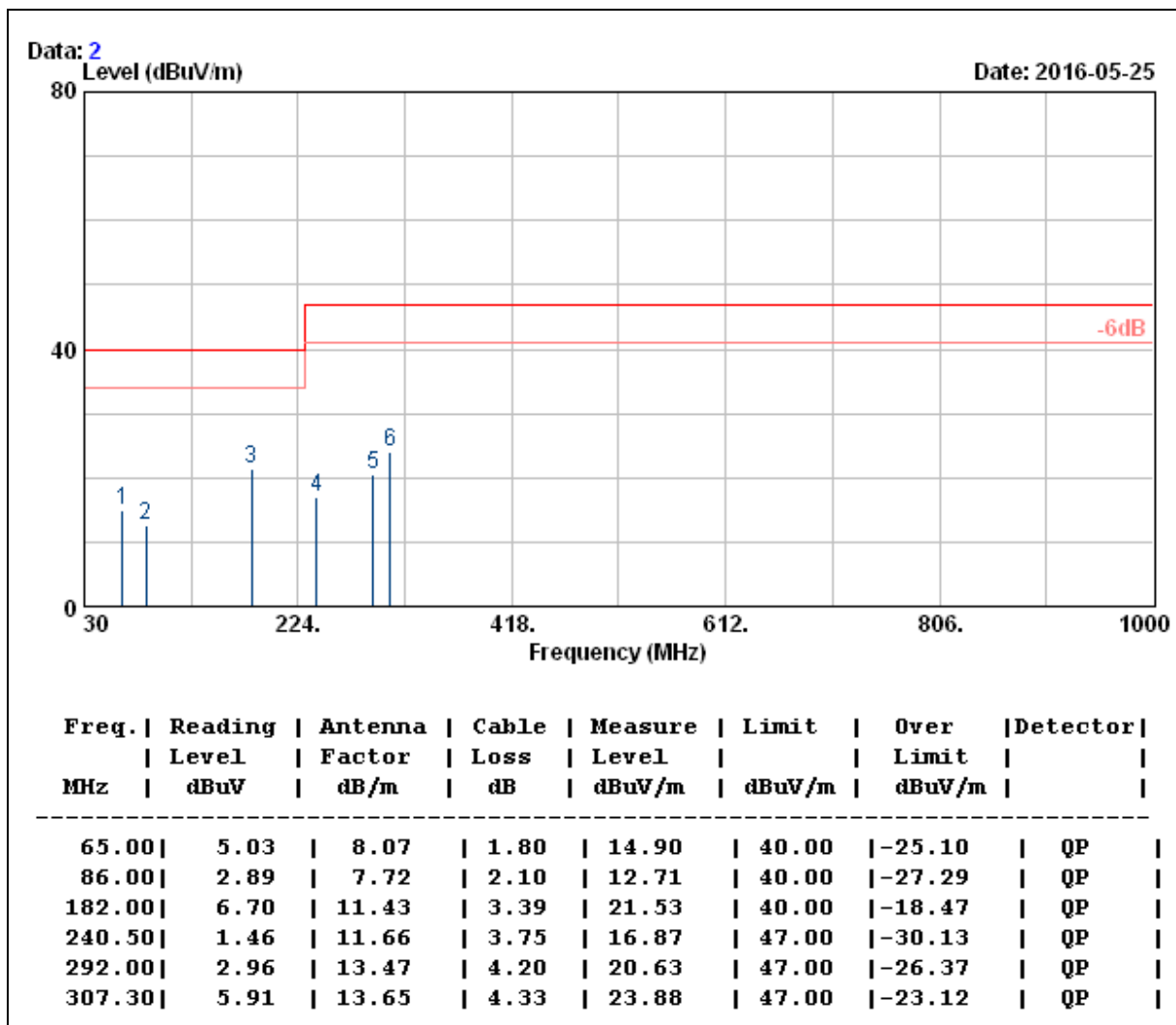

Note: 1.Level (dBuV/m) = Read Level (dBuV) + Antenna Factor (dB/m) + Cable loss (dB)
2.Over Limit value (dB) = Level (dBuV/m)-Limit Line(dBuV/m)

Model No.	ERM00CC18-HS	Test Mode	Full Load
Environmental Conditions	26.8°C, 54% RH	Resolution Bandwidth	120 kHz
Antenna Pole	Horizontal	Antenna Distance	10m
Detector Function	Quasi-peak.	Tested by	Weici Lo

(The chart below shows the highest readings taken from the final data.)

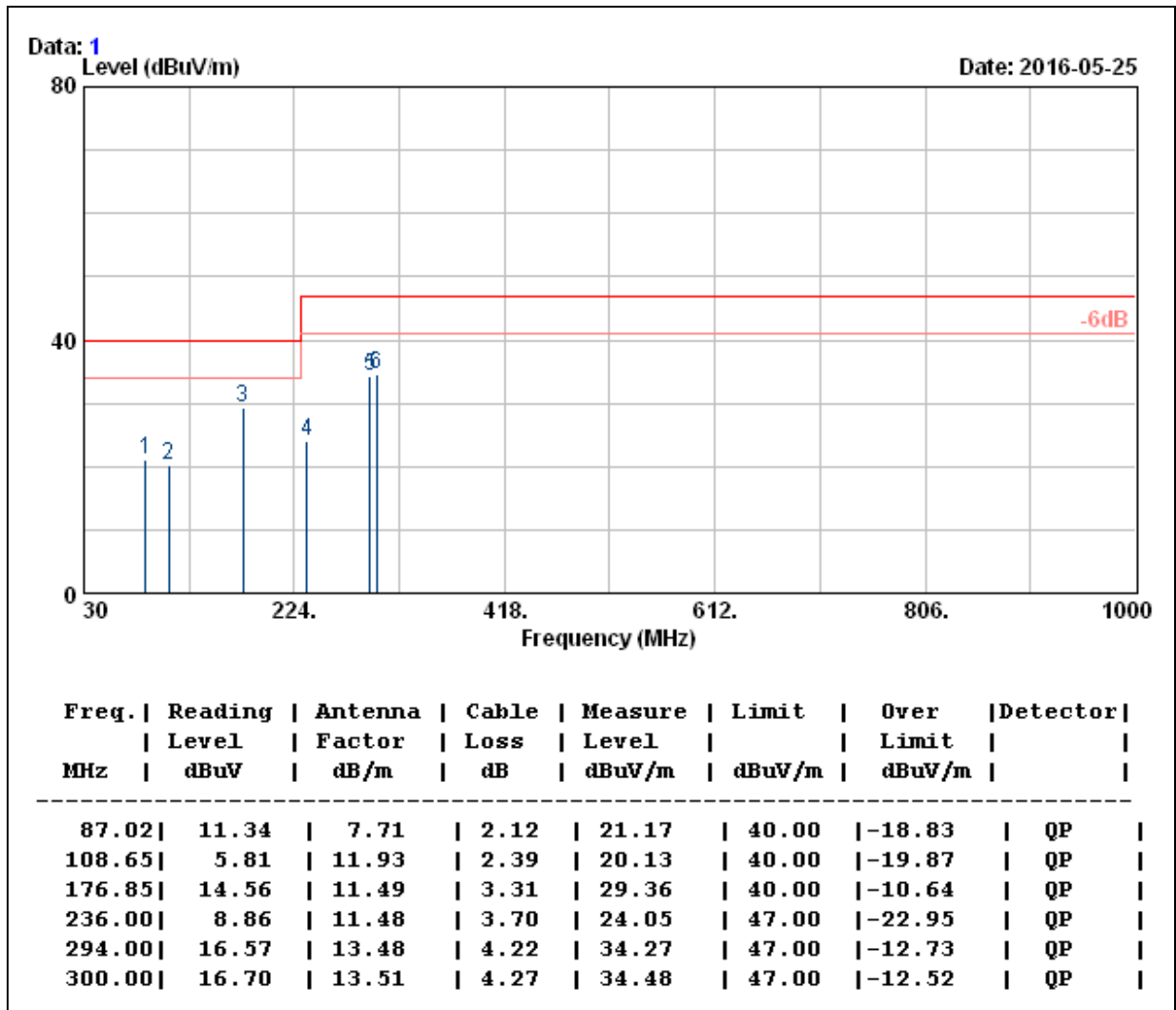

Note: 1.Level (dBuV/m) = Read Level (dBuV) + Antenna Factor (dB/m) + Cable loss (dB)
2.Over Limit value (dB) = Level (dBuV/m)-Limit Line(dBuV/m)

Model No.	ERM02A18-HS	Test Mode	Full Load
Environmental Conditions	26.8°C, 54% RH	Resolution Bandwidth	120 kHz
Antenna Pole	Vertical	Antenna Distance	10m
Detector Function:	Quasi-peak.	Tested By	Weici Lo

(The chart below shows the highest readings taken from the final data.)

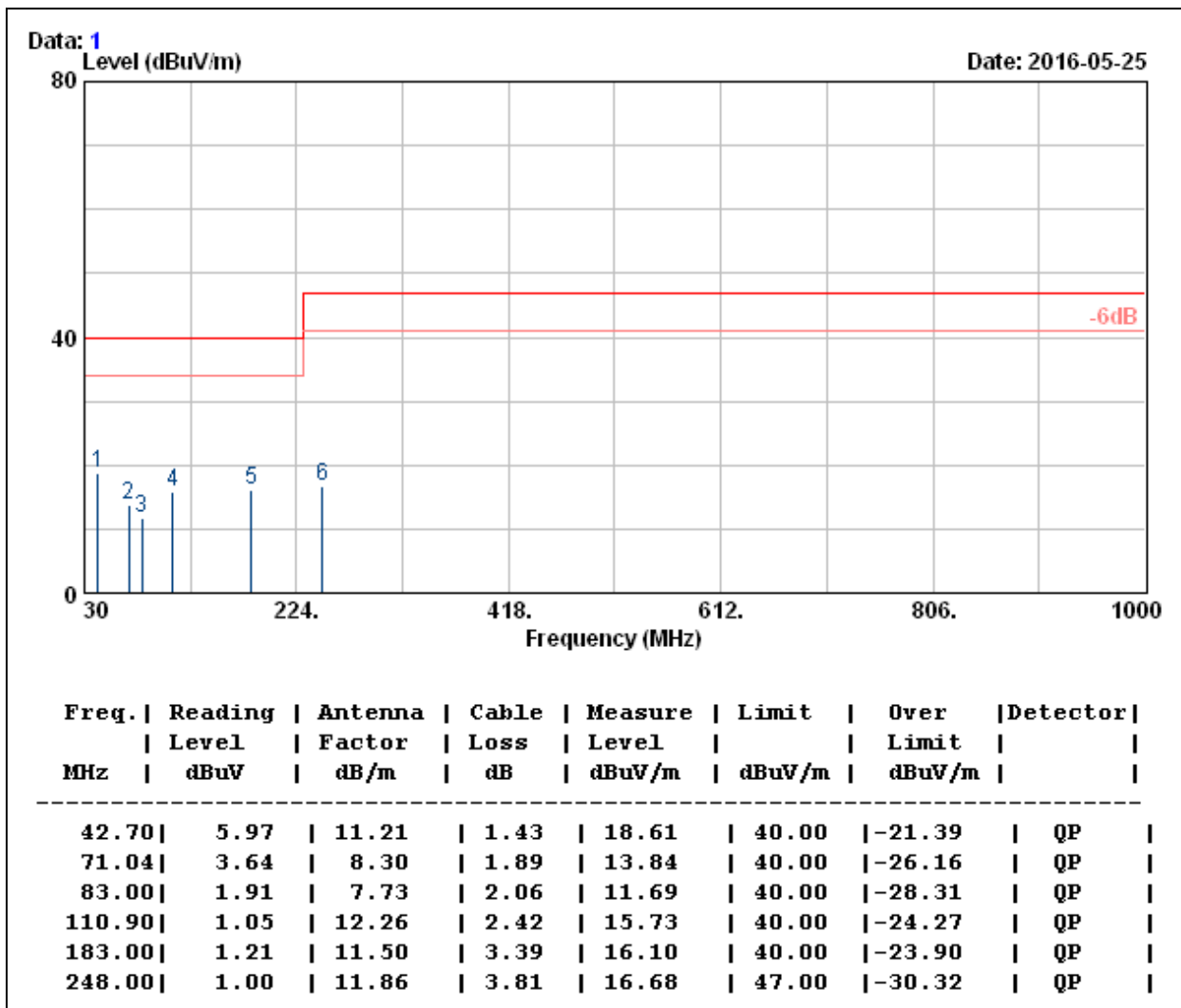

Note: 1.Level (dBuV/m) = Read Level (dBuV) + Antenna Factor (dB/m) + Cable loss (dB)
2.Over Limit value (dB) = Level (dBuV/m)-Limit Line(dBuV/m)

Model No.	ERM02A18-HS	Test Mode	Full load
Environmental Conditions	26.8°C, 54% RH	Resolution Bandwidth	120 kHz
Antenna Pole	Horizontal	Antenna Distance	10m
Detector Function	Quasi-peak.	Tested By	Weici Lo

(The chart below shows the highest readings taken from the final data.)

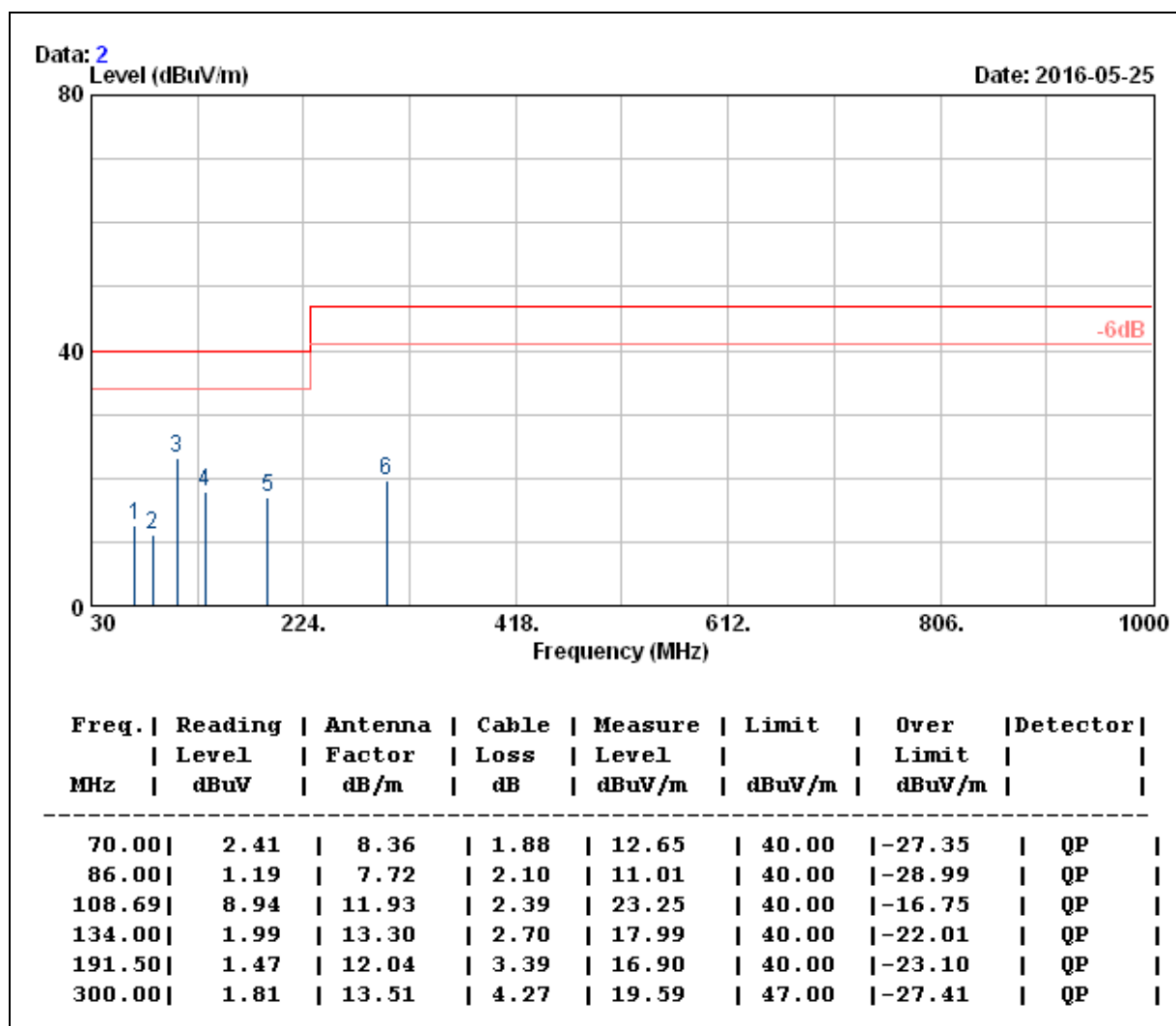

Note: 1. Level (dBuV/m) = Read Level (dBuV) + Antenna Factor (dB/m) + Cable loss (dB)
2. Over Limit value (dB) = Level (dBuV/m) - Limit Line (dBuV/m)

Model No.	ERM00CC110-HS	Test Mode	Full load
Environmental Conditions	26.8°C, 54% RH	Resolution Bandwidth	120 kHz
Antenna Pole	Vertical	Antenna Distance	10m
Detector Function:	Quasi-peak.	Tested By	Weici Lo

(The chart below shows the highest readings taken from the final data.)

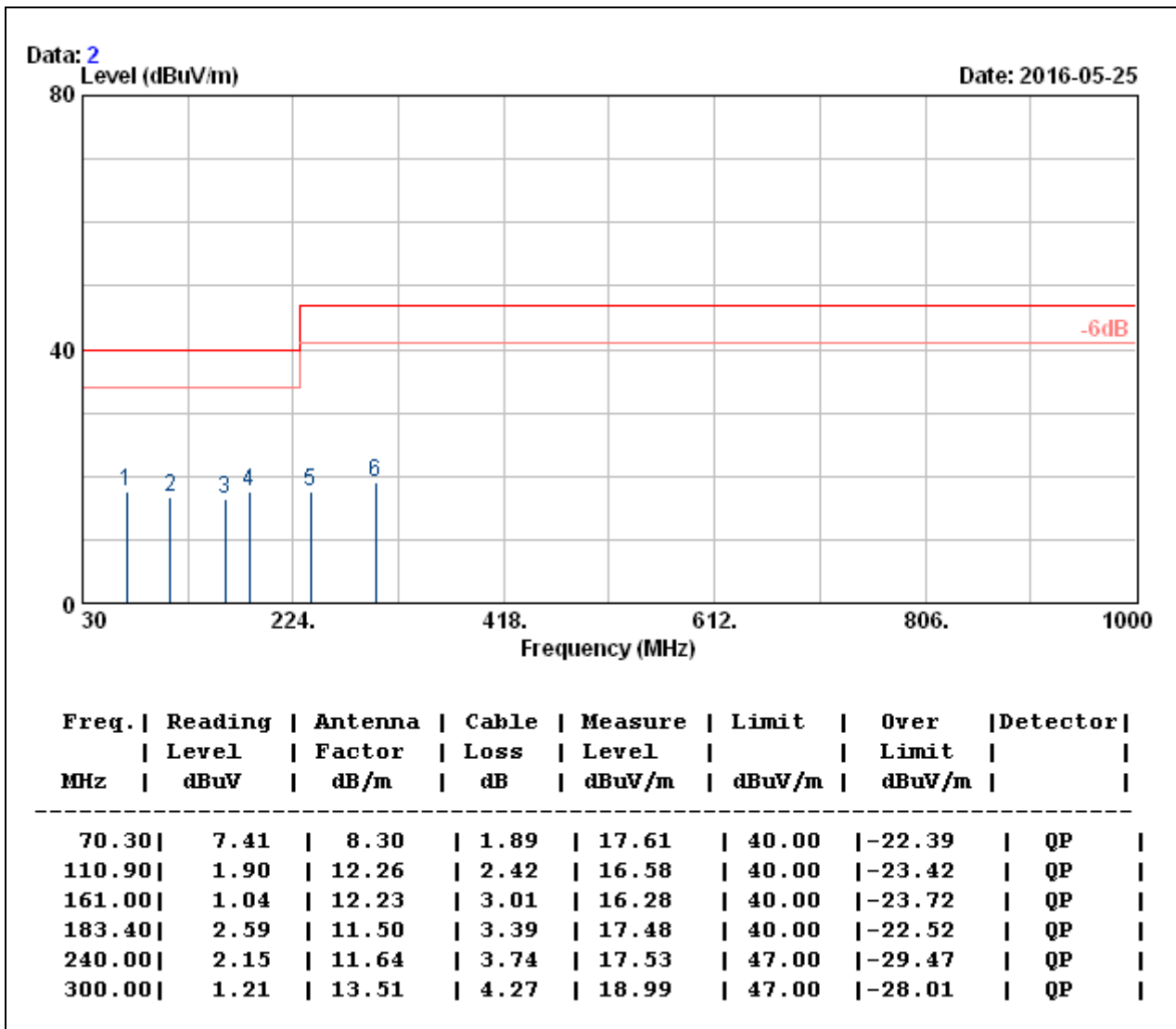

Note: 1. Level (dBuV/m) = Read Level (dBuV) + Antenna Factor (dB/m) + Cable loss (dB)
2. Over Limit value (dB) = Level (dBuV/m) - Limit Line (dBuV/m)

Model No.	ERM00CC110-HS	Test Mode	Full load
Environmental Conditions	26.8°C, 54% RH	Resolution Bandwidth	120 kHz
Antenna Pole	Horizontal	Antenna Distance	10m
Detector Function	Quasi-peak.	Tested By	Weici Lo

(The chart below shows the highest readings taken from the final data.)

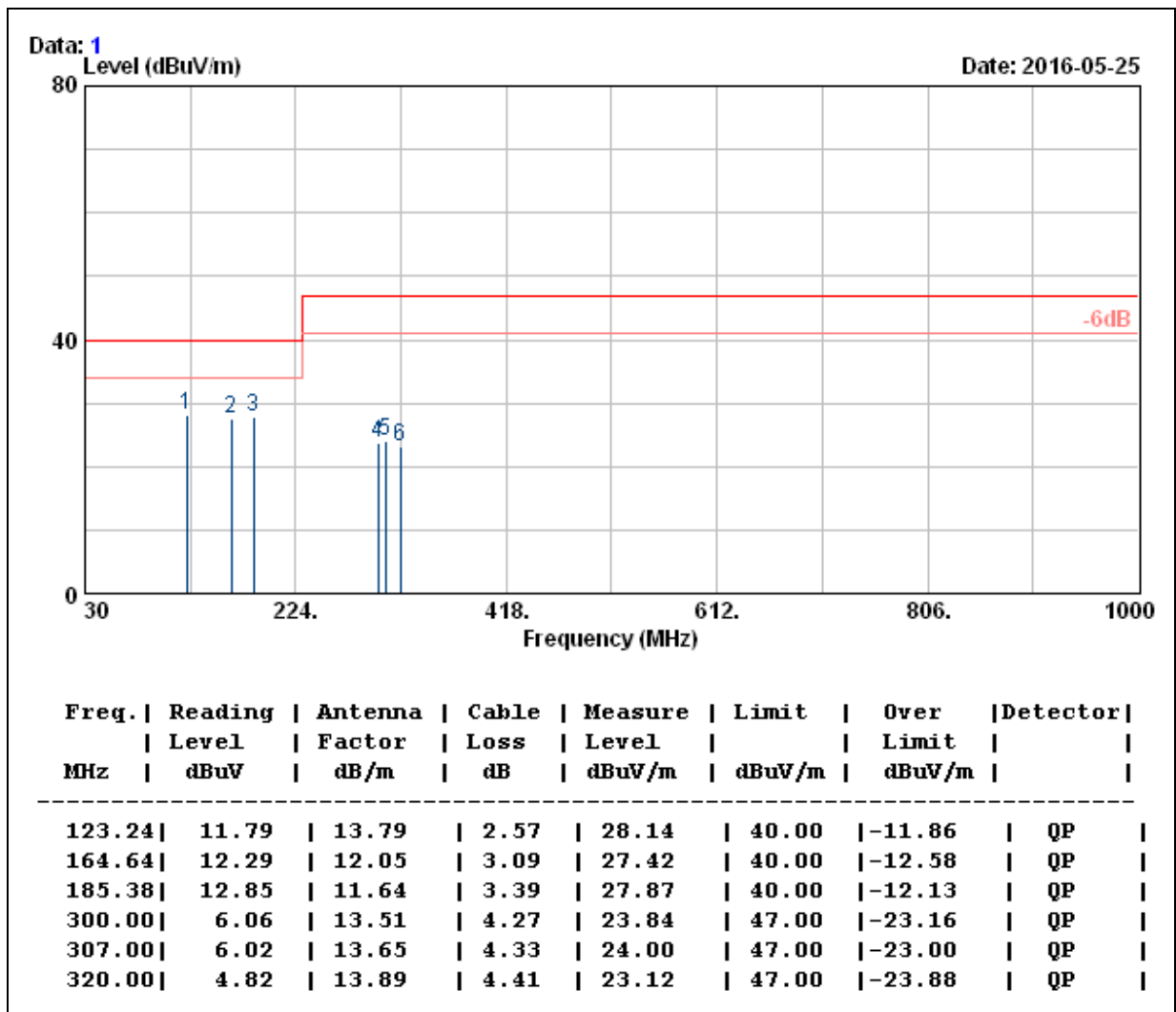

- Note: 1.Level (dBuV/m) = Read Level (dBuV) + Antenna Factor (dB/m) + Cable loss (dB)
- 2.Over Limit value (dB) = Level (dBuV/m)-Limit Line(dBuV/m)

Model No.	ERM02A110-HS	Test Mode	Full load
Environmental Conditions	26.8°C, 54% RH	Resolution Bandwidth	120 kHz
Antenna Pole	Vertical	Antenna Distance	10m
Detector Function:	Quasi-peak.	Tested By	Weici Lo

(The chart below shows the highest readings taken from the final data.)

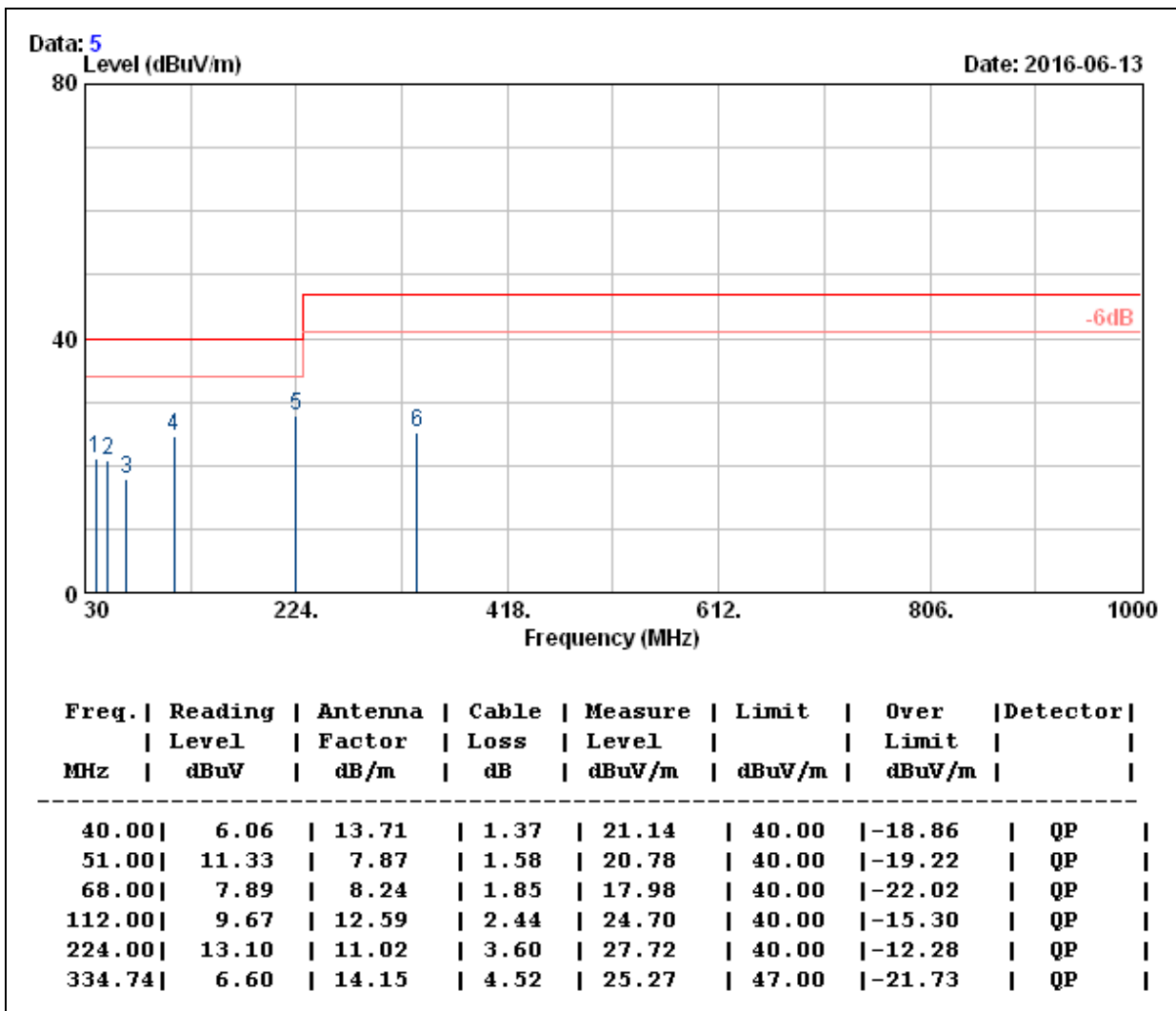

Note: 1.Level (dBUV/m) = Read Level (dBUV) + Antenna Factor (dB/m) + Cable loss (dB)
2.Over Limit value (dB) = Level (dBUV/m)-Limit Line(dBUV/m)

Model No.	ERM02A110-HS	Test Mode	Full load
Environmental Conditions	26.8°C, 54% RH	Resolution Bandwidth	120 kHz
Antenna Pole	Horizontal	Antenna Distance	10m
Detector Function	Quasi-peak.	Tested By	Weici Lo

(The chart below shows the highest readings taken from the final data.)

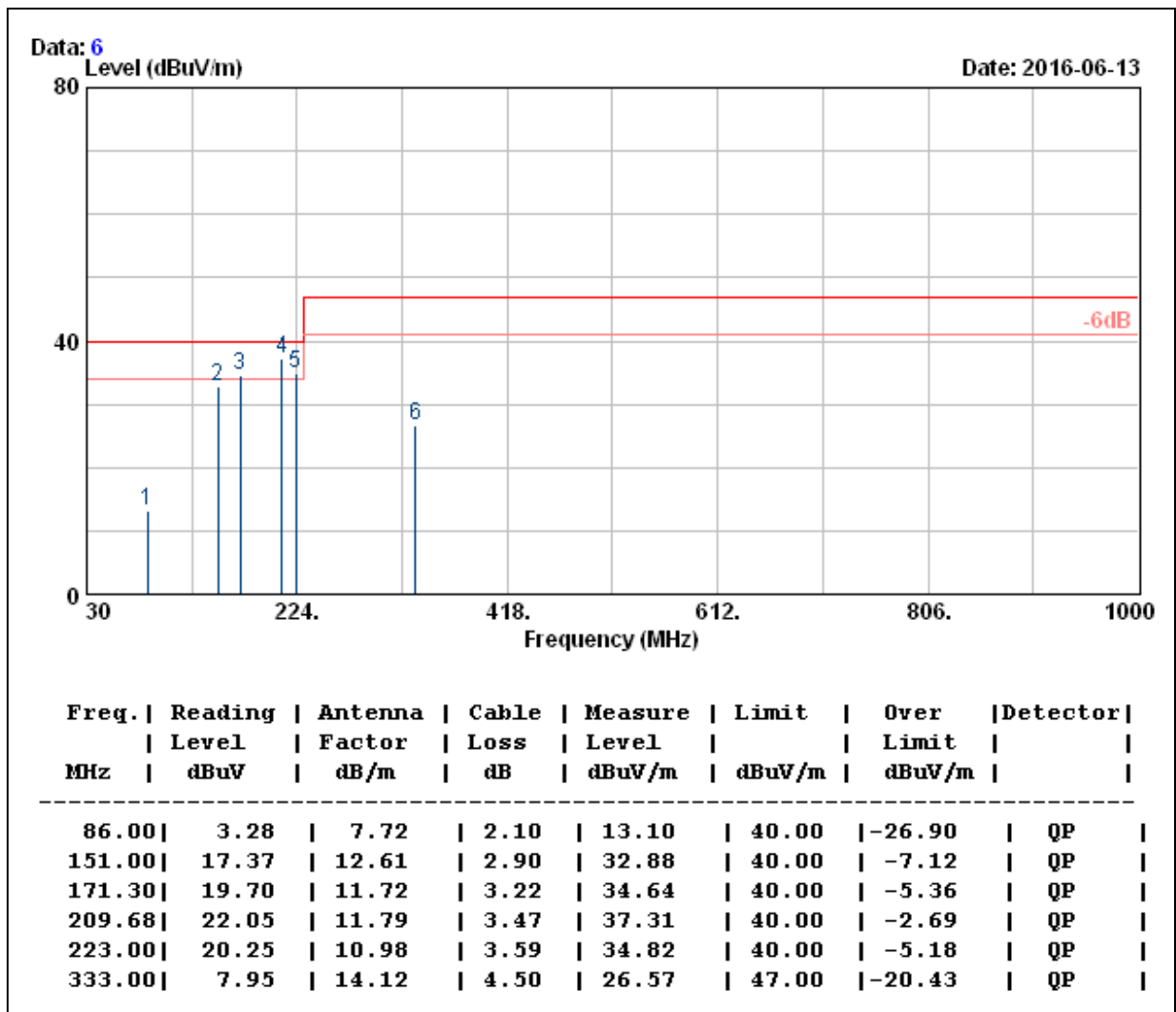

- Note: 1.Level (dBuV/m) = Read Level (dBuV) + Antenna Factor (dB/m) + Cable loss (dB)
- 2.Over Limit value (dB) = Level (dBuV/m)-Limit Line(dBuV/m)

Model No.	ERM01CC18-HS	Test Mode	Full Load
Environmental Conditions	26.8°C, 54% RH	Resolution Bandwidth	120 kHz
Antenna Pole	Vertical	Antenna Distance	10m
Detector Function	Quasi-peak.	Tested by	Weici Lo

(The chart below shows the highest readings taken from the final data.)

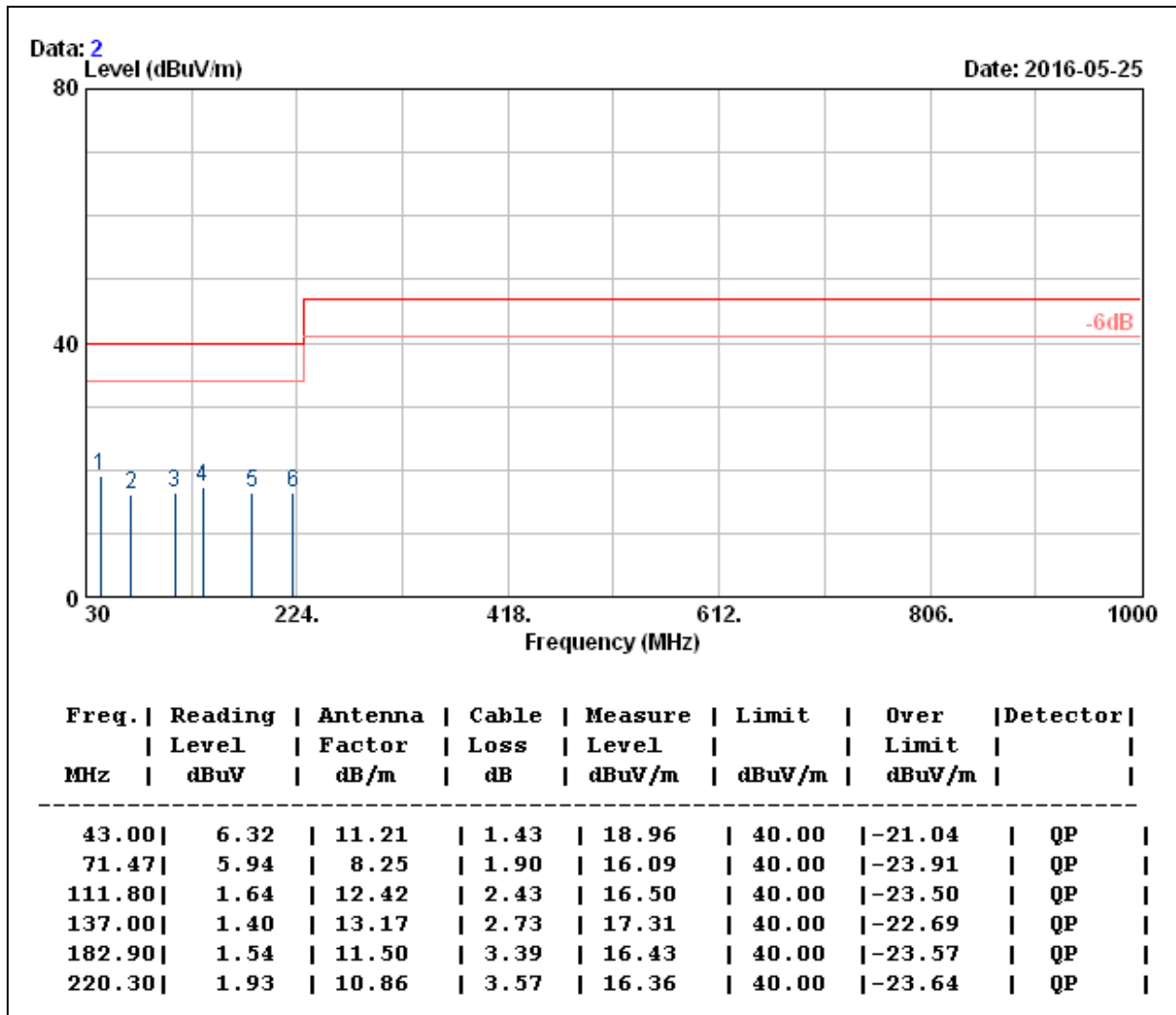

Note: 1.Level (dBuV/m) = Read Level (dBuV) + Antenna Factor (dB/m) + Cable loss (dB)
2.Over Limit value (dB) = Level (dBuV/m)-Limit Line(dBuV/m)

Model No.	ERM01CC18-HS	Test Mode	Full Load
Environmental Conditions	26.8°C, 54% RH	Resolution Bandwidth	120 kHz
Antenna Pole	Horizontal	Antenna Distance	10m
Detector Function	Quasi-peak.	Tested by	Weici Lo

(The chart below shows the highest readings taken from the final data.)

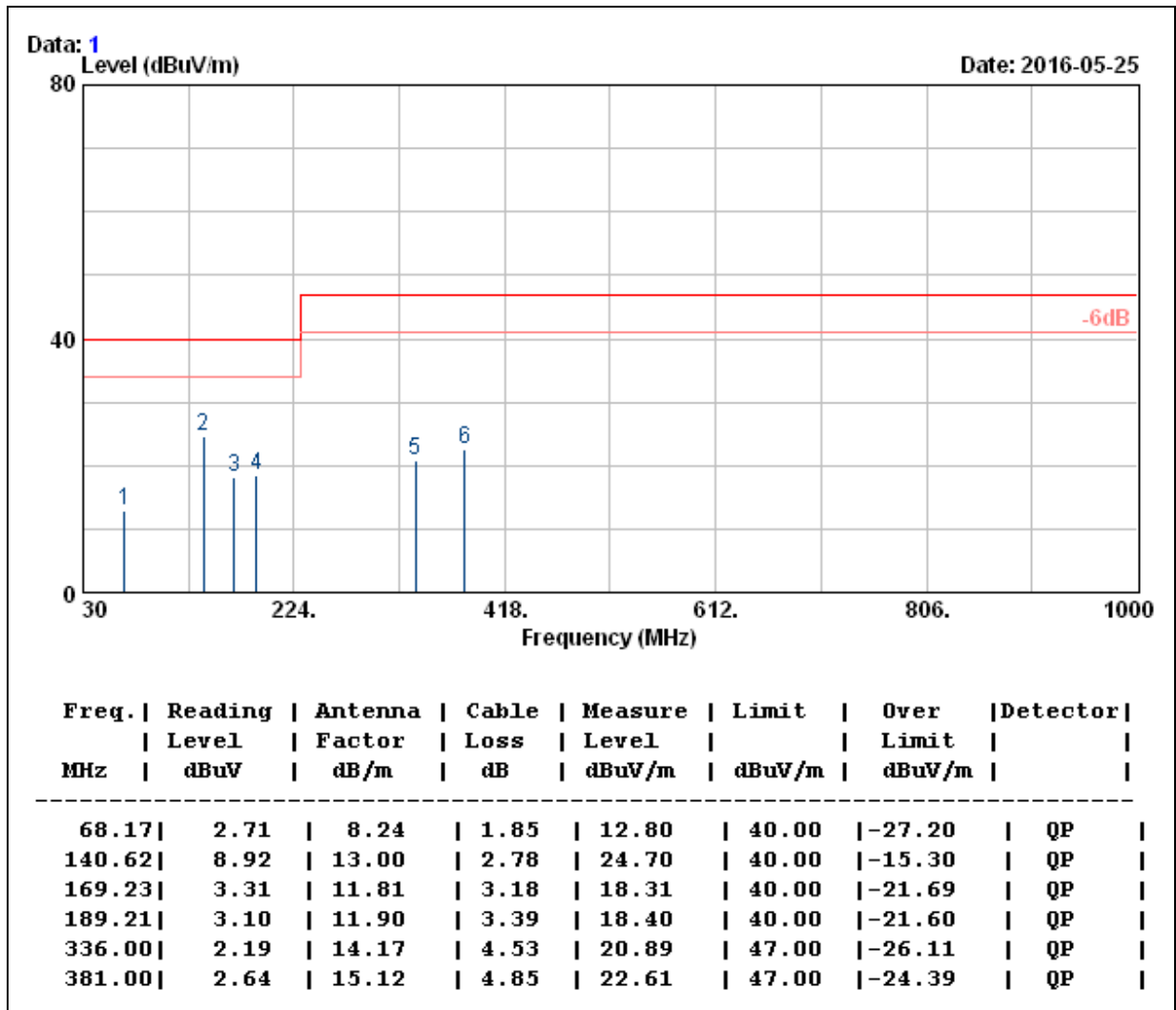

Note: 1.Level (dBuV/m) = Read Level (dBuV) + Antenna Factor (dB/m) + Cable loss (dB)
2.Over Limit value (dB) = Level (dBuV/m)-Limit Line(dBuV/m)

Model No.	ERM04A18-HS	Test Mode	Full Load
Environmental Conditions	26.8°C, 54% RH	Resolution Bandwidth	120 kHz
Antenna Pole	Vertical	Antenna Distance	10m
Detector Function:	Quasi-peak.	Tested By	Weici Lo

(The chart below shows the highest readings taken from the final data.)

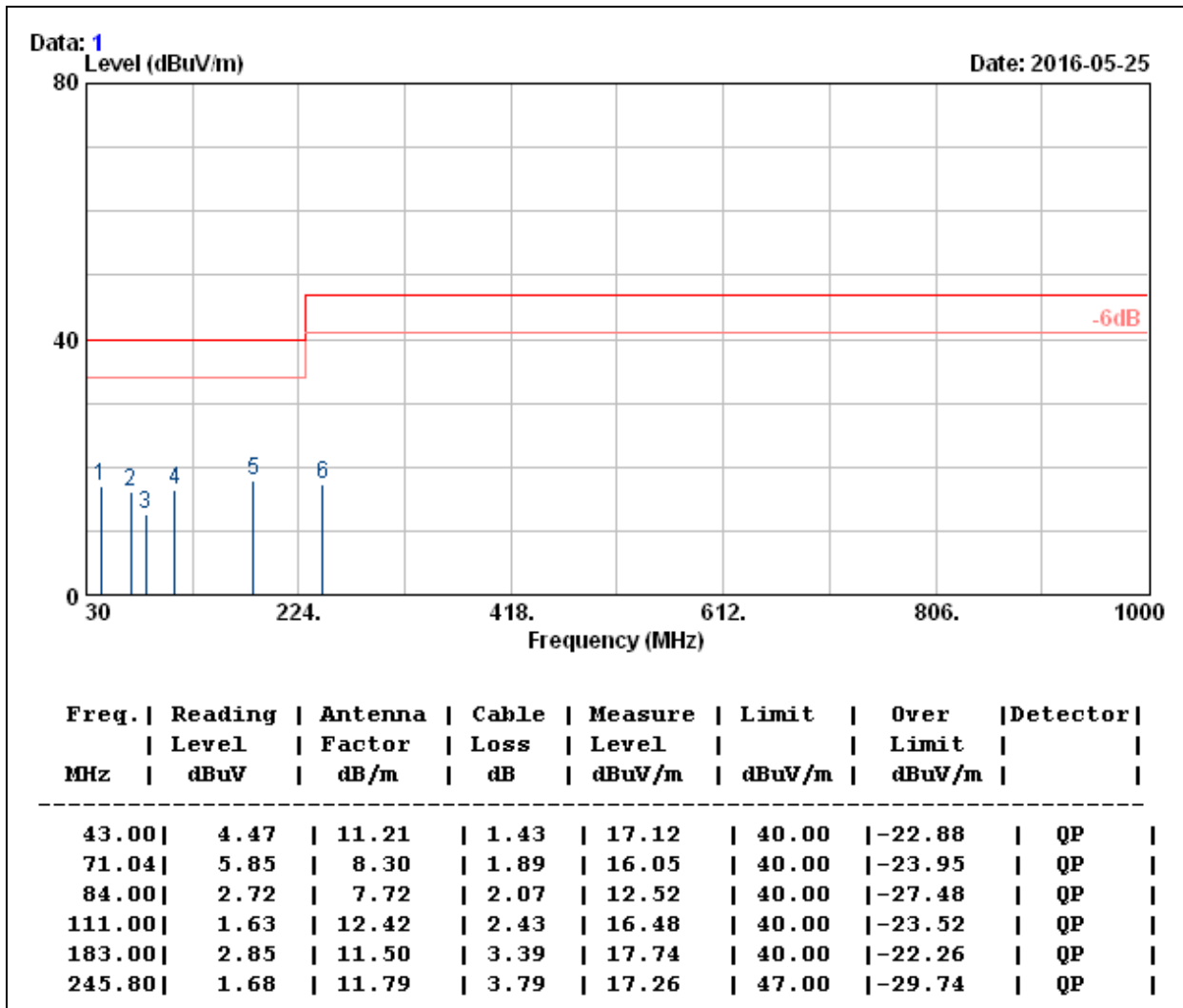

Note: 1.Level (dBuV/m) = Read Level (dBuV) + Antenna Factor (dB/m) + Cable loss (dB)

2.Over Limit value (dB) = Level (dBuV/m)-Limit Line(dBuV/m)

Model No.	ERM04A18-HS	Test Mode	Full load
Environmental Conditions	26.8°C, 54% RH	Resolution Bandwidth	120 kHz
Antenna Pole	Horizontal	Antenna Distance	10m
Detector Function	Quasi-peak.	Tested By	Weici Lo

(The chart below shows the highest readings taken from the final data.)

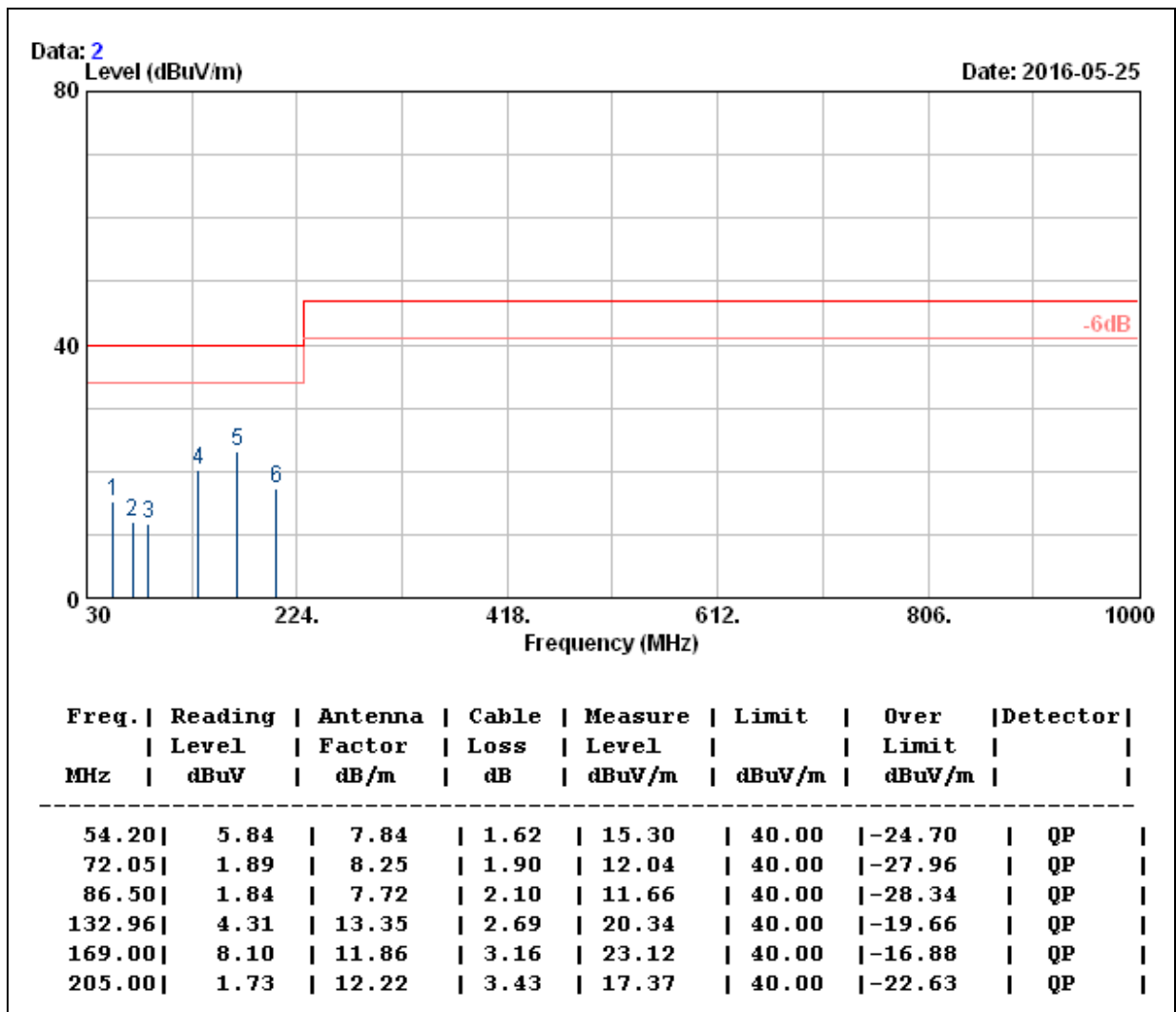

Note: 1.Level (dBuV/m) = Read Level (dBuV) + Antenna Factor (dB/m) + Cable loss (dB)

2.Over Limit value (dB) = Level (dBuV/m)-Limit Line(dBuV/m)

Model No.	ERM01CC110-HS	Test Mode	Full load
Environmental Conditions	26.8°C, 54% RH	Resolution Bandwidth	120 kHz
Antenna Pole	Vertical	Antenna Distance	10m
Detector Function:	Quasi-peak.	Tested By	Weici Lo

(The chart below shows the highest readings taken from the final data.)

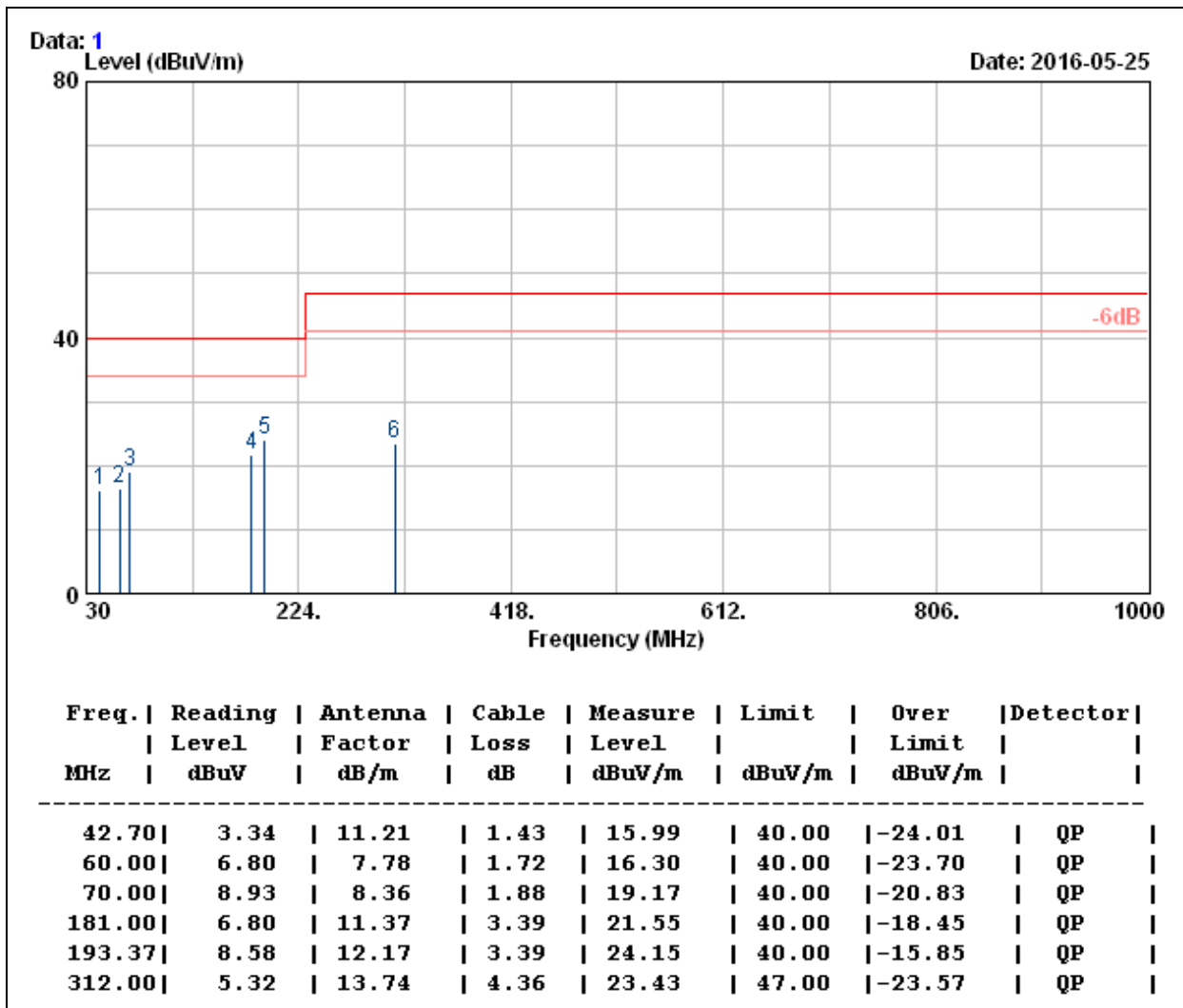

- Note: 1. Level (dBuV/m) = Read Level (dBuV) + Antenna Factor (dB/m) + Cable loss (dB)
2. Over Limit value (dB) = Level (dBuV/m) - Limit Line (dBuV/m)

Model No.	ERM01CC110-HS	Test Mode	Full load
Environmental Conditions	26.8°C, 54% RH	Resolution Bandwidth	120 kHz
Antenna Pole	Horizontal	Antenna Distance	10m
Detector Function	Quasi-peak.	Tested By	Weici Lo

(The chart below shows the highest readings taken from the final data.)

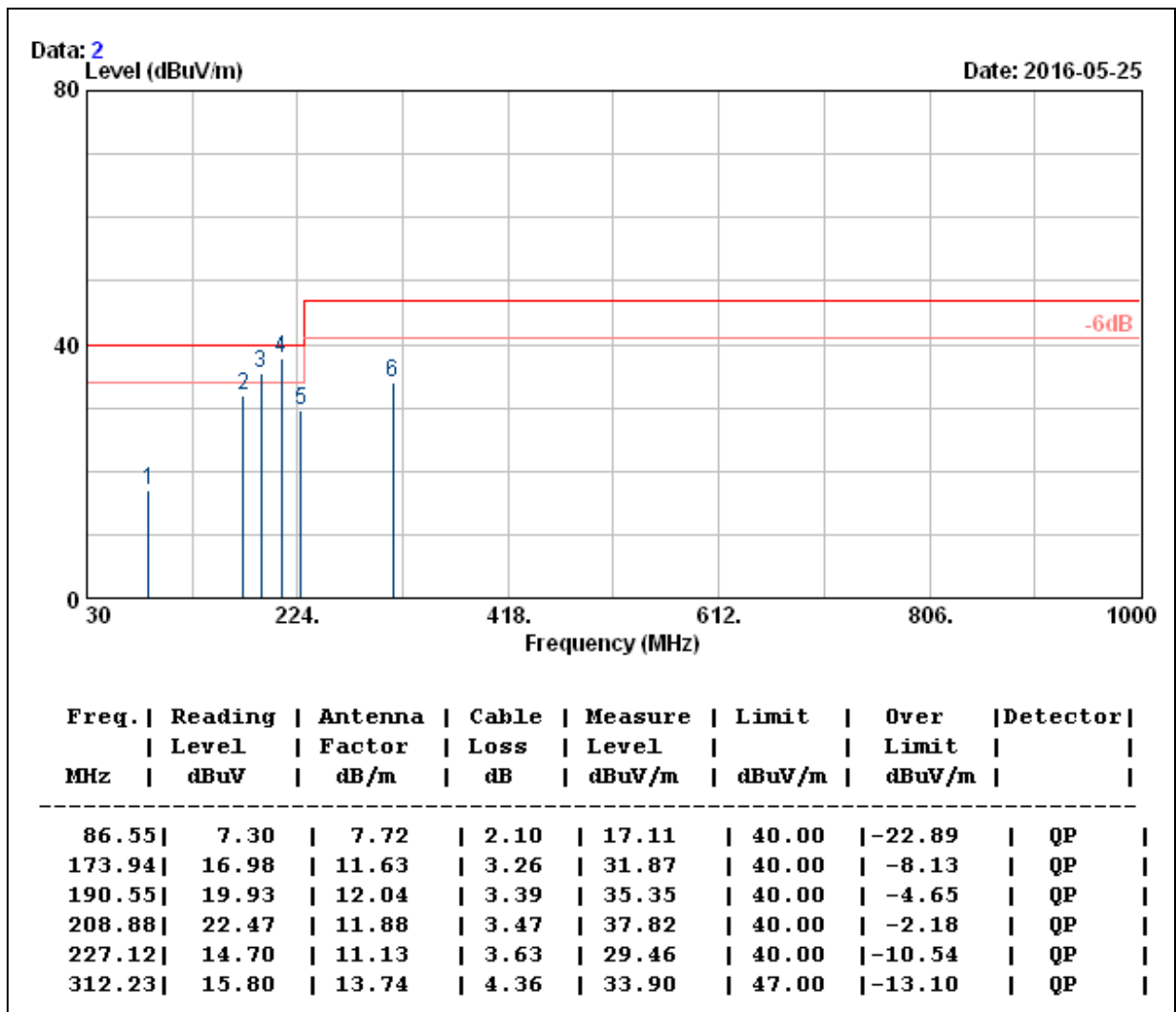

Note: 1.Level (dBuV/m) = Read Level (dBuV) + Antenna Factor (dB/m) + Cable loss (dB)

2.Over Limit value (dB) = Level (dBuV/m)-Limit Line(dBuV/m)

Model No.	ERM04A110-HS	Test Mode	Full load
Environmental Conditions	26.8°C, 54% RH	Resolution Bandwidth	120 kHz
Antenna Pole	Vertical	Antenna Distance	10m
Detector Function:	Quasi-peak.	Tested By	Weici Lo

(The chart below shows the highest readings taken from the final data.)

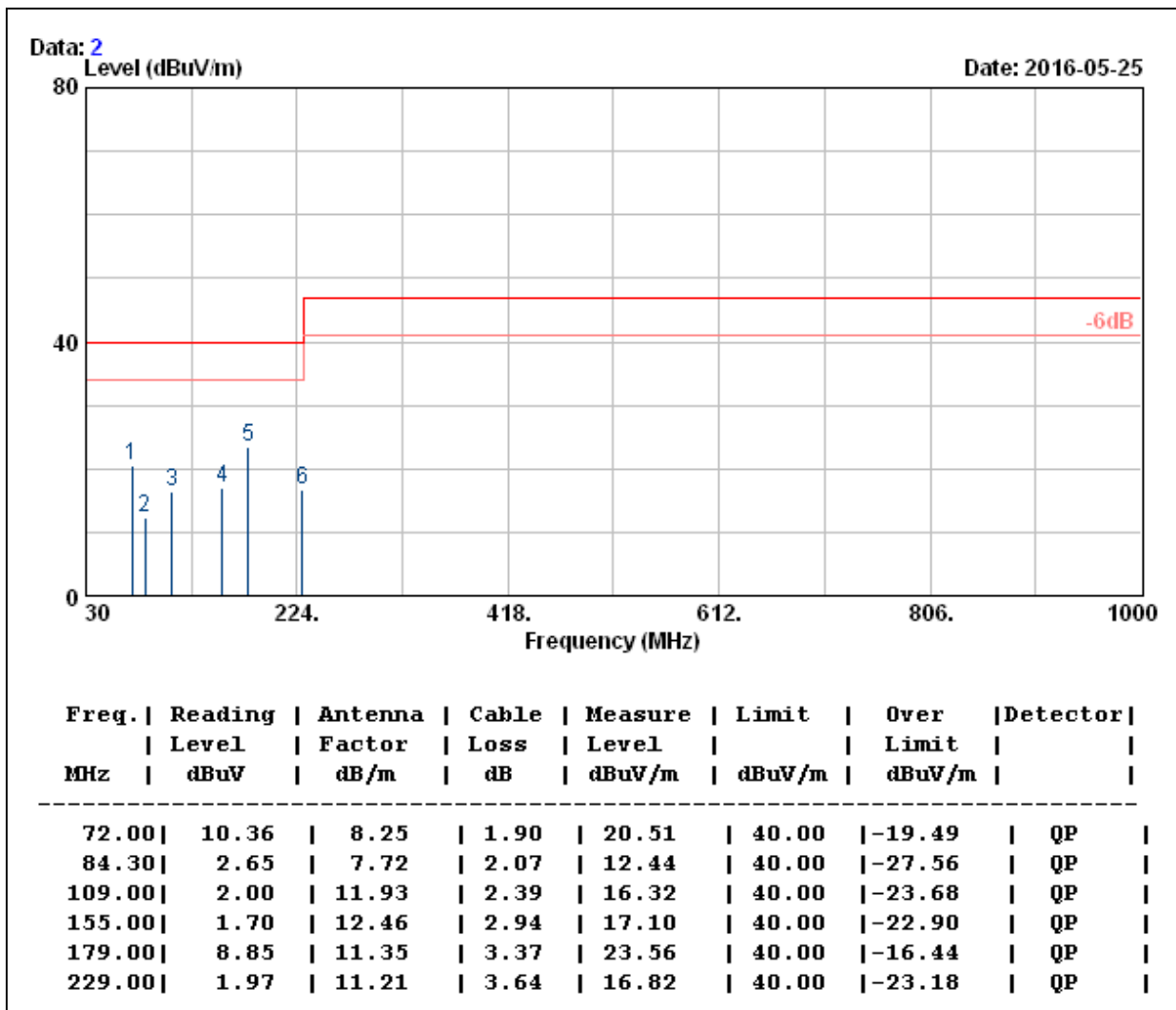

Note: 1.Level (dBUV/m) = Read Level (dBUV) + Antenna Factor (dB/m) + Cable loss (dB)
2.Over Limit value (dB) = Level (dBUV/m)-Limit Line(dBUV/m)

Model No.	ERM04A110-HS	Test Mode	Full load
Environmental Conditions	26.8°C, 54% RH	Resolution Bandwidth	120 kHz
Antenna Pole	Horizontal	Antenna Distance	10m
Detector Function	Quasi-peak.	Tested By	Weici Lo

(The chart below shows the highest readings taken from the final data.)

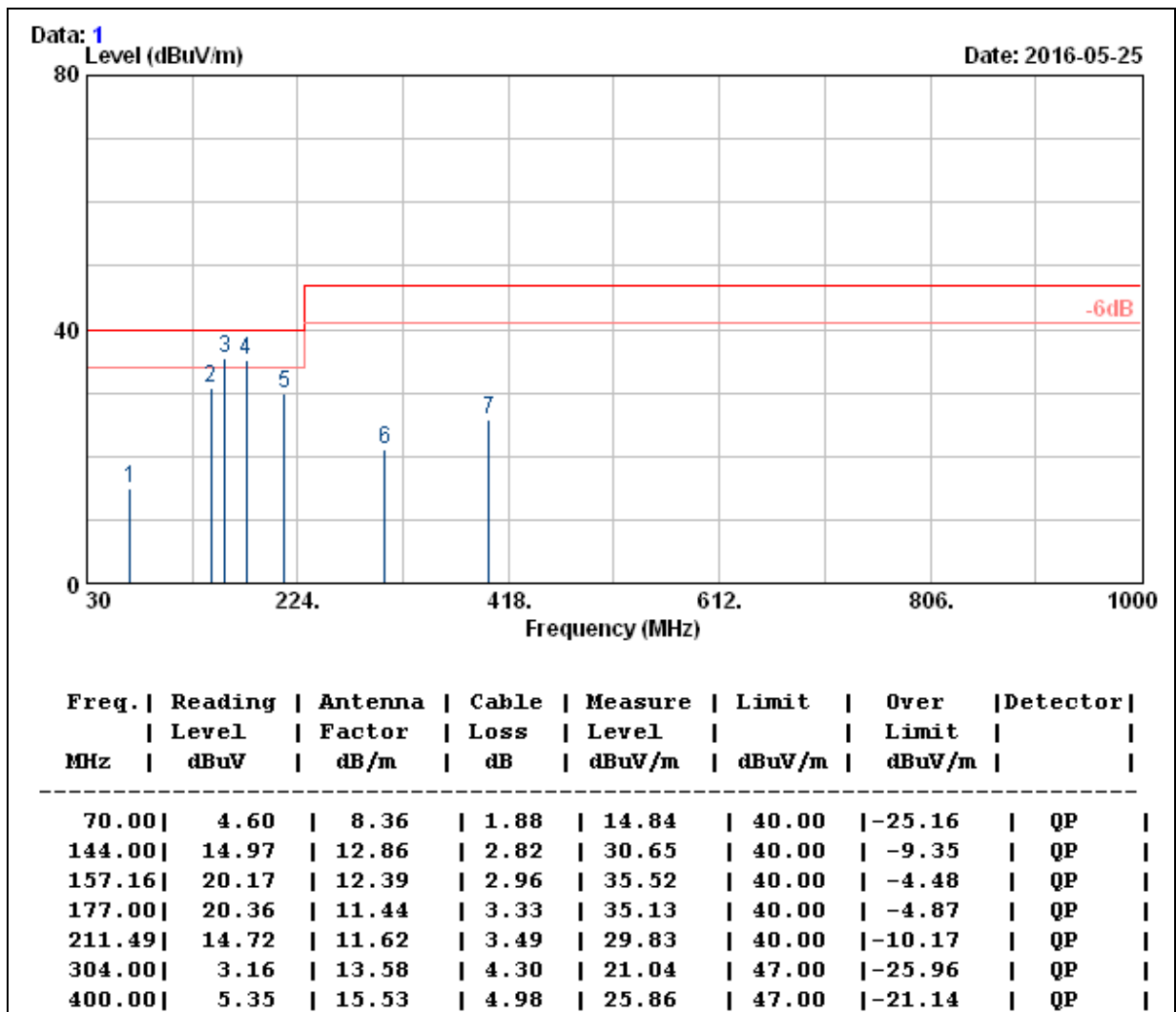

Note: 1.Level (dBuV/m) = Read Level (dBuV) + Antenna Factor (dB/m) + Cable loss (dB)
2.Over Limit value (dB) = Level (dBuV/m)-Limit Line(dBuV/m)

Above 1GHz

※ Not applicable, since the highest frequency of the internal sources of the EUT is less than 108MHz, the measurement shall only be made up to 1 GHz.

7.4. HARMONICS CURRENT MEASUREMENT

7.4.1. LIMITS OF HARMONICS CURRENT MEASUREMENT

Limits for Class A equipment		Limits for Class D equipment		
Harmonics Order n	Max. permissible harmonics current A	Harmonics Order n	Max. permissible harmonics current per watt mA/W	Max. permissible harmonics current A
Odd harmonics		Odd Harmonics only		
3	2.30	3	3.4	2.30
5	1.14	5	1.9	1.14
7	0.77	7	1.0	0.77
9	0.40	9	0.5	0.40
11	0.33	11	0.35	0.33
13	0.21	13	0.30	0.21
15<=n<=39	0.15x15/n	15<=n<=39	3.85/n	0.15x15/n
Even harmonics				
2	1.08			
4	0.43			
6	0.30			
8<=n<=40	0.23x8/n			

Note:

1. Class A and Class D are classified according to item 7.4.3.
2. According to section 7 of EN 61000-3-2, the above limits for all equipment except for lighting equipment having an active input power > 75 W and no limits apply for equipment with an active input power up to and including 75 W.

7.4.2. TEST INSTRUMENTS

Name of Equipment	Manufacturer	Model	Serial Number	Calibration Due
Harmonic & Flicker Test System	Teseq	Proflin 2105(NSG 1007/CCN 1000-1)	1504A02655	03/02/2017
Software	H/F HA 1600 PC LINK Field Probe			

Note: The calibration interval of the above test instruments is 12 months and the calibrations are traceable to NML/ROC and NIST/USA.

7.4.3. TEST PROCEDURE

The EUT was placed on the top of a wooden table 0.8 meters above the ground and operated to produce the maximum harmonic components under normal operating conditions for each successive harmonic component in turn.

The classification of EUT is according to section 5 of EN 61000-3-2.

The EUT is classified as follows:

- Class A: Balanced three-phase equipment, Household appliances excluding equipment as Class D, Tools excluding portable tools, Dimmers for incandescent lamps, audio equipment, equipment not specified in one of the three other classes.
- Class B: Portable tools; Arc welding equipment which is not professional equipment.
- Class C: Lighting equipment.
- Class D: Equipment having a specified power less than or equal to 600 W of the following types: Personal computers and personal computer monitors and television receivers.

The correspondent test program of test instrument to measure the current harmonics emanated from EUT is chosen. The measure time shall be not less than the time necessary for the EUT to be exercised.

7.4.4. TEST SETUP

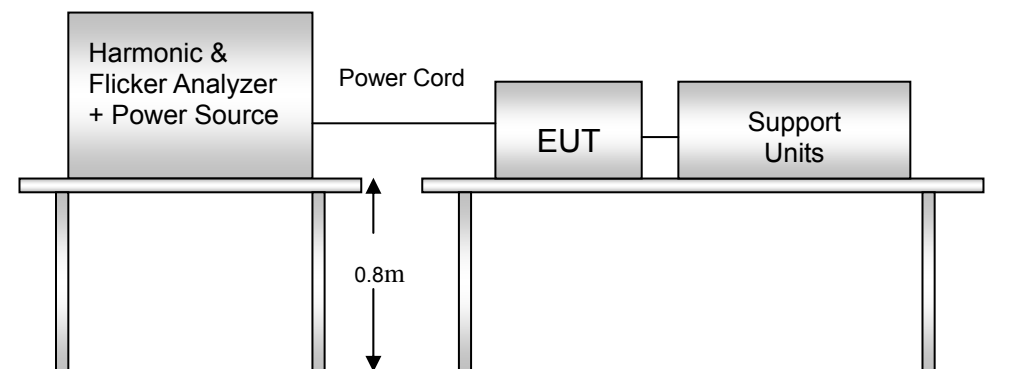

For the actual test configuration, please refer to the related item - Photographs of the Test Configuration.

7.4.5. TEST RESULTS

Power Consumption	---W	Test Results	---
Environmental Conditions	---°C, ---% RH, ---mbar	Limits	Class <input type="checkbox"/> A <input type="checkbox"/> B <input type="checkbox"/> C <input type="checkbox"/> D
Test Mode	---	Tested by	---

Test result of EN 61000-3-2

✘ This EUT is not connected to AC Source directly. Not applicable for this test.

7.5. VOLTAGE FLUCTUATION AND FLICKER MEASUREMENT

7.5.1. LIMITS OF VOLTAGE FLUCTUATION AND FLICKER MEASUREMENT

TEST ITEM	LIMIT	REMARK
P_{st}	1.0	P_{st} means short-term flicker indicator.
P_{lt}	0.65	P_{lt} means long-term flicker indicator.
T_{dt} (ms)	500	T_{dt} means maximum time that dt exceeds 3 %.
d_{max} (%)	4%	d_{max} means maximum relative voltage change.
dc (%)	3.3%	dc means relative steady-state voltage change

7.5.2. TEST INSTRUMENTS

Name of Equipment	Manufacturer	Model	Serial Number	Calibration Due
Harmonic & Flicker Test System	Teseq	Proflin 2105(NSG 1007/CCN 1000-1)	1504A02655	03/02/2017
Software	H/F HA 1600 PC LINK Field Probe			

Note: The calibration interval of the above test instruments is 12 months and the calibrations are traceable to NML/ROC and NIST/USA.

7.5.3. TEST PROCEDURE

The EUT was placed on the top of a wooden table 0.8 meters above the ground and operated to produce the most unfavorable sequence of voltage changes under normal operating conditions.

During the flick measurement, the measure time shall include that part of whole operation cycle in which the EUT produce the most unfavorable sequence of voltage changes. The observation period for short-term flicker indicator is 10 minutes and the observation period for long-term flicker indicator is 2 hours.

7.5.4. TEST SETUP

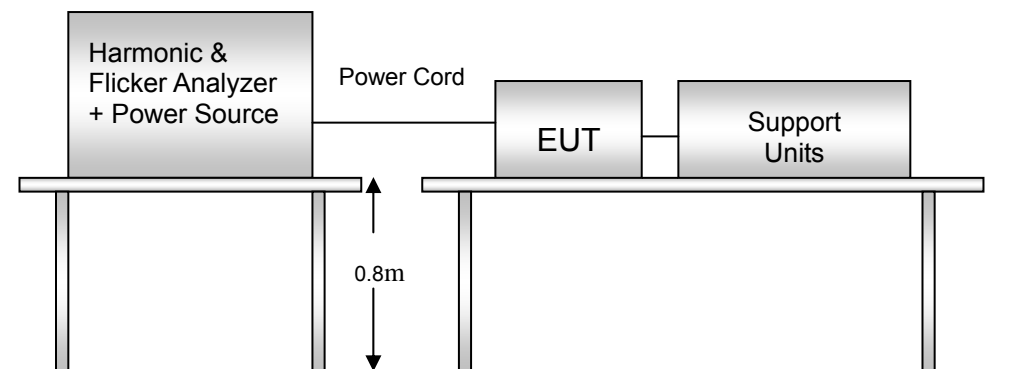

For the actual test configuration, please refer to the related item - Photographs of the Test Configuration.

7.5.5. TEST RESULTS

Observation Period (Tp)	---	Test Mode	---
Environmental Conditions	---°C, ---% RH, ---mbar	Tested by	---

Test result of EN 61000-3-3

✘ This EUT is not connected to AC Source directly. Not applicable for this test.

8 IMMUNITY TEST

8.1. GENERAL DESCRIPTION

Product Standard	EN 55024: 2010	
	Test Type	Minimum Requirement
Basic Standard, Specification, and Performance Criterion required	IEC 61000-4-2	Electrostatic Discharge - ESD: 8KV air discharge, 4kV Contact discharge, Performance Criterion B
	IEC 61000-4-3	Radio-Frequency Electromagnetic Field Susceptibility Test - RS: 80 ~1000 MHz, 3V/m, 80% AM(1kHz), Performance Criterion A
	IEC 61000-4-4	Electrical Fast Transient/Burst - EFT, AC Power Port: 1kV DC Power Port: 0.5kV Signal Ports and Telecommunication Ports: 0.5kV Performance Criterion B
	IEC 61000-4-5	Surge Immunity Test: 1.2/50 us Open Circuit Voltage, 8/20 us Short Circuit Current, AC Power Port ~ line to line: 1kV, line to earth (ground): 2kV DC Power Port ~ line to earth: 0.5kV Signal and Telecommunication Ports ~ line to ground: 1kV Performance Criterion B
	IEC 61000-4-6	Conducted Radio Frequency Disturbances Test - CS: 0.15 ~ 80 MHz, 3Vrms, 80% AM, 1kHz, Performance Criterion A
	IEC 61000-4-8	Power frequency magnetic field immunity test 50 Hz, 1A/m Performance Criterion A
	IEC 61000-4-11	Voltage Dips: i) >95% reduction for 0.5 periods, Performance Criterion B ii) 30% reduction for 25 periods, Performance Criterion C Voltage Interruptions: >95% reduction for 250 periods Performance Criterion C

8.2. GENERAL PERFORMANCE CRITERIA DESCRIPTION

Criteria A:	The apparatus shell continues to operate as intended without operator intervention. No degradation of performance or loss of function is allowed below a performance level specified by the manufacturer, when the apparatus is used as intended. The performance level may be replaced by a permissible loss of performance. If the manufacturer does not specify the minimum performance level or the permissible performance loss, then either of these may be derived from the product description and documentation, and by what the user may reasonably expect from the equipment if used as intended.
Criteria B:	After test, the apparatus shell continues to operate as intended without operator intervention. No degradation of performance or loss of function is allowed, after the application of the phenomenon below a performance level specified by the manufacturer, when the apparatus is used as intended. The performance level may be replaced by a permissible loss of performance. During the test, degradation of performance is however allowed. However, no change of operating state if stored data is allowed to persist after the test. If the manufacturer does not specify the minimum performance level or the permissible performance loss, then either of these may be derived from the product description and documentation, and by what the user may reasonably expect from the equipment if used as intended.
Criteria C:	Temporary loss of function is allowed, provided the functions is self-recoverable or can be restored by the operation of controls by the user in accordance with the manufacturer instructions. Functions, and/or information stored in non-volatile memory, or protected by a battery backup, shall not be lost.

8.3. ELECTROSTATIC DISCHARGE (ESD)

8.3.1. TEST SPECIFICATION

Basic Standard:	IEC 61000-4-2
Discharge Impedance:	330 ohm / 150 pF
Discharge Voltage:	Air Discharge: 2, 4, 8 kV (Direct) Contact Discharge: 4, 6 kV (Direct/Indirect)
Polarity:	Positive & Negative
Number of Discharge:	Air Discharge: min. 10 times at each test point for each polarity Contact Discharge: min. 200 times in total
Discharge Mode:	Single Discharge 1 second minimum

8.3.2. TEST INSTRUMENT

IMMUNITY SHIELDED ROOM				
Name of Equipment	Manufacturer	Model	Serial Number	Calibration Due
ESD Simulator	NoiseKen	TC-815R	ESS1366835	08/24/2016
ESD Simulator	NoiseKen	ESS-2002	ESS04Z3762	08/14/2016

Note: The calibration interval of the above test instruments is 12 months and the calibrations are traceable to NML/ROC and NIST/USA.

8.3.3. TEST PROCEDURE

The discharges shall be applied in two ways:

- a) Contact discharges to the conductive surfaces and coupling planes:
The EUT shall be exposed to at least 200 discharges, 100 each at negative and positive polarity, at a minimum of four test points. One of the test points shall be subjected to at least 50 indirect discharges to the center of the front edge of the **Horizontal Coupling Plane (HCP)**. The remaining three test points shall each receive at least 50 direct contact discharges. If no direct contact test points are available, then at least 200 indirect discharges shall be applied in the indirect mode. Test shall be performed at a maximum repetition rate of one discharge per second.
- b) Air discharges at slots and apertures and insulating surfaces:
On those parts of the EUT where it is not possible to perform contact discharge testing, the equipment should be investigated to identify user accessible points where breakdown may occur. Such points are tested using the air discharge method. This investigation should be restricted to those area normally handled by the user. A minimum of 10 single air discharges shall be applied to the selected test point for each such area.

The basic test procedure was in accordance with IEC 61000-4-2:

- a) The EUT was located 0.1 m minimum from all side of the **HCP** (dimensions 1.6m x 0.8m).
- b) The support units were located another table 30 cm away from the EUT, but direct support unit was/were located at same location as EUT on the HCP and keep at a distance of 10 cm with EUT.
- c) The time interval between two successive single discharges was at least 1 second.
- d) Contact discharges were applied to the non-insulating coating, with the pointed tip of the generator penetrating the coating and contacting the conducting substrate.
- e) Air discharges were applied with the round discharge tip of the discharge electrode approaching the EUT as fast as possible (without causing mechanical damage) to touch the EUT. After each discharge, the ESD generator was removed from the EUT and re-triggered for a new single discharge. The test was repeated until all discharges were complete.
- f) At least ten single discharges (in the most sensitive polarity) were applied at the front edge of each **HCP** opposite the center point of each unit of the EUT and 0.1 meters from the front of the EUT. The long axis of the discharge electrode was in the plane of the **HCP** and perpendicular to its front edge during the discharge.
- g) At least ten single discharges (in the most sensitive polarity) were applied to the center of one vertical edge of the **Vertical Coupling Plane (VCP)** in sufficiently different positions that the four faces of the EUT were completely illuminated. The **VCP** (dimensions 0.5m x 0.5m) was placed vertically to and 0.1 meters from the EUT.

8.3.4. TEST SETUP

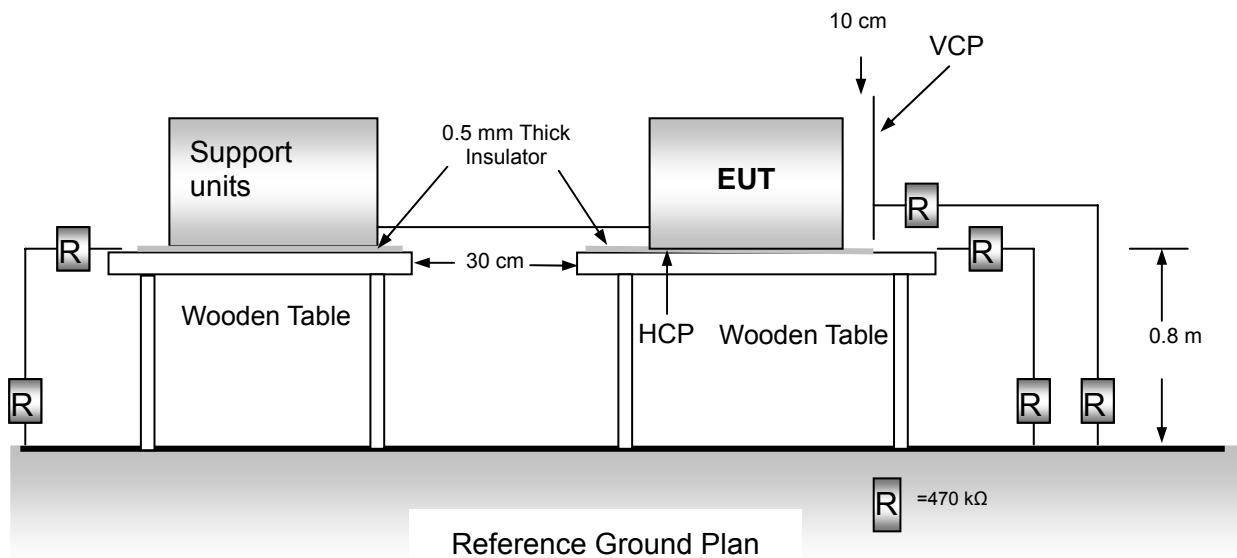

For the actual test configuration, please refer to the related item – Photographs of the Test Configuration.

Note:

TABLETOP EQUIPMENT

The configuration consisted of a wooden table 0.8 meters high standing on the **Ground Reference Plane**. The **GRP** consisted of a sheet of aluminum at least 0.25mm thick, and 2.5 meters square connected to the protective grounding system. A **Horizontal Coupling Plane** (1.6m x 0.8m) was placed on the table and attached to the **GRP** by means of a cable with 940kohm total impedance. The equipment under test, was installed in a representative system as described in section 7 of IEC 61000-4-2, and its cables were placed on the **HCP** and isolated by an insulating support of 0.5mm thickness. A distance of 1-meter minimum was provided between the EUT and the walls of the laboratory and any other metallic structure.

FLOOR-STANDING EQUIPMENT

The equipment under test was installed in a representative system as described in section 7 of IEC 61000-4-2, and its cables were isolated from the Ground Reference Plane by an insulating support of 0.1-meter thickness. The GRP consisted of a sheet of aluminum that is at least 0.25mm thick, and 2.5 meters square connected to the protective grounding system and extended at least 0.5 meters from the EUT on all sides.

8.3.5. TEST RESULTS

Model: ERM02A18-HS

Temperature	23°C	Humidity	45% RH
Pressure	1028mbar	Tested By	Taiyu Cyu
Required Passing Performance		Criterion B	

Air Discharge							
Test Points	Test Levels			Results			
	± 2 kV	± 4 kV	± 8 kV	Pass	Fail	Performance Criterion	
Front	<input type="checkbox"/>	<input type="checkbox"/>	<input type="checkbox"/>	<input type="checkbox"/>	<input type="checkbox"/>	<input type="checkbox"/> A	<input type="checkbox"/> B
Back	<input type="checkbox"/>	<input type="checkbox"/>	<input type="checkbox"/>	<input type="checkbox"/>	<input type="checkbox"/>	<input type="checkbox"/> A	<input type="checkbox"/> B
Left	<input type="checkbox"/>	<input type="checkbox"/>	<input type="checkbox"/>	<input type="checkbox"/>	<input type="checkbox"/>	<input type="checkbox"/> A	<input type="checkbox"/> B
Right	<input type="checkbox"/>	<input type="checkbox"/>	<input type="checkbox"/>	<input type="checkbox"/>	<input type="checkbox"/>	<input type="checkbox"/> A	<input type="checkbox"/> B
Top	<input type="checkbox"/>	<input type="checkbox"/>	<input type="checkbox"/>	<input type="checkbox"/>	<input type="checkbox"/>	<input type="checkbox"/> A	<input type="checkbox"/> B
Bottom	<input checked="" type="checkbox"/>	<input checked="" type="checkbox"/>	<input checked="" type="checkbox"/>	<input checked="" type="checkbox"/>	<input type="checkbox"/>	<input checked="" type="checkbox"/> A	<input type="checkbox"/> B

Contact Discharge							
Test Points	Test Levels			Results			
	± 2 kV	± 4 kV	± 8 kV	Pass	Fail	Performance Criterion	
Front	<input type="checkbox"/>	<input checked="" type="checkbox"/>	<input type="checkbox"/>	<input checked="" type="checkbox"/>	<input type="checkbox"/>	<input checked="" type="checkbox"/> A	<input type="checkbox"/> B
Back	<input type="checkbox"/>	<input checked="" type="checkbox"/>	<input type="checkbox"/>	<input checked="" type="checkbox"/>	<input type="checkbox"/>	<input checked="" type="checkbox"/> A	<input type="checkbox"/> B
Left	<input type="checkbox"/>	<input checked="" type="checkbox"/>	<input type="checkbox"/>	<input checked="" type="checkbox"/>	<input type="checkbox"/>	<input checked="" type="checkbox"/> A	<input type="checkbox"/> B
Right	<input type="checkbox"/>	<input checked="" type="checkbox"/>	<input type="checkbox"/>	<input checked="" type="checkbox"/>	<input type="checkbox"/>	<input checked="" type="checkbox"/> A	<input type="checkbox"/> B
Top	<input type="checkbox"/>	<input checked="" type="checkbox"/>	<input type="checkbox"/>	<input checked="" type="checkbox"/>	<input type="checkbox"/>	<input checked="" type="checkbox"/> A	<input type="checkbox"/> B
Bottom	<input type="checkbox"/>	<input type="checkbox"/>	<input type="checkbox"/>	<input type="checkbox"/>	<input type="checkbox"/>	<input type="checkbox"/> A	<input type="checkbox"/> B

Discharge To Horizontal Coupling Plane							
Side of EUT	Test Levels			Results			
	± 2 kV	± 4 kV	± 6 kV	Pass	Fail	Performance Criterion	
Front	<input type="checkbox"/>	<input checked="" type="checkbox"/>	<input type="checkbox"/>	<input checked="" type="checkbox"/>	<input type="checkbox"/>	<input checked="" type="checkbox"/> A	<input type="checkbox"/> B
Back	<input type="checkbox"/>	<input checked="" type="checkbox"/>	<input type="checkbox"/>	<input checked="" type="checkbox"/>	<input type="checkbox"/>	<input checked="" type="checkbox"/> A	<input type="checkbox"/> B
Left	<input type="checkbox"/>	<input checked="" type="checkbox"/>	<input type="checkbox"/>	<input checked="" type="checkbox"/>	<input type="checkbox"/>	<input checked="" type="checkbox"/> A	<input type="checkbox"/> B
Right	<input type="checkbox"/>	<input checked="" type="checkbox"/>	<input type="checkbox"/>	<input checked="" type="checkbox"/>	<input type="checkbox"/>	<input checked="" type="checkbox"/> A	<input type="checkbox"/> B

Discharge To Vertical Coupling Plane							
Side of EUT	Test Levels			Results			
	± 2 kV	± 4 kV	± 6 kV	Pass	Fail	Performance Criterion	
Front	<input type="checkbox"/>	<input checked="" type="checkbox"/>	<input type="checkbox"/>	<input checked="" type="checkbox"/>	<input type="checkbox"/>	<input checked="" type="checkbox"/> A	<input type="checkbox"/> B
Back	<input type="checkbox"/>	<input checked="" type="checkbox"/>	<input type="checkbox"/>	<input checked="" type="checkbox"/>	<input type="checkbox"/>	<input checked="" type="checkbox"/> A	<input type="checkbox"/> B
Left	<input type="checkbox"/>	<input checked="" type="checkbox"/>	<input type="checkbox"/>	<input checked="" type="checkbox"/>	<input type="checkbox"/>	<input checked="" type="checkbox"/> A	<input type="checkbox"/> B
Right	<input type="checkbox"/>	<input checked="" type="checkbox"/>	<input type="checkbox"/>	<input checked="" type="checkbox"/>	<input type="checkbox"/>	<input checked="" type="checkbox"/> A	<input type="checkbox"/> B

For Strict Test

Temperature	23°C	Humidity	45% RH
Pressure	1028mbar	Tested By	Taiyu Cyu
Required Passing Performance		Criterion B	

Air Discharge							
Test Points	Test Levels			Results			
	± 2 kV	± 4 kV	± 8 kV	Pass	Fail	Performance Criterion	
Front	<input type="checkbox"/>	<input type="checkbox"/>	<input type="checkbox"/>	<input type="checkbox"/>	<input type="checkbox"/>	<input type="checkbox"/> A	<input type="checkbox"/> B
Back	<input type="checkbox"/>	<input type="checkbox"/>	<input type="checkbox"/>	<input type="checkbox"/>	<input type="checkbox"/>	<input type="checkbox"/> A	<input type="checkbox"/> B
Left	<input type="checkbox"/>	<input type="checkbox"/>	<input type="checkbox"/>	<input type="checkbox"/>	<input type="checkbox"/>	<input type="checkbox"/> A	<input type="checkbox"/> B
Right	<input type="checkbox"/>	<input type="checkbox"/>	<input type="checkbox"/>	<input type="checkbox"/>	<input type="checkbox"/>	<input type="checkbox"/> A	<input type="checkbox"/> B
Top	<input type="checkbox"/>	<input type="checkbox"/>	<input type="checkbox"/>	<input type="checkbox"/>	<input type="checkbox"/>	<input type="checkbox"/> A	<input type="checkbox"/> B
Bottom	<input checked="" type="checkbox"/>	<input checked="" type="checkbox"/>	<input checked="" type="checkbox"/>	<input checked="" type="checkbox"/>	<input type="checkbox"/>	<input checked="" type="checkbox"/> A	<input type="checkbox"/> B

Contact Discharge							
Test Points	Test Levels			Results			
	± 2 kV	± 4 kV	± 6 kV	Pass	Fail	Performance Criterion	
Front	<input type="checkbox"/>	<input type="checkbox"/>	<input checked="" type="checkbox"/>	<input checked="" type="checkbox"/>	<input type="checkbox"/>	<input checked="" type="checkbox"/> A	<input type="checkbox"/> B
Back	<input type="checkbox"/>	<input type="checkbox"/>	<input checked="" type="checkbox"/>	<input checked="" type="checkbox"/>	<input type="checkbox"/>	<input checked="" type="checkbox"/> A	<input type="checkbox"/> B
Left	<input type="checkbox"/>	<input type="checkbox"/>	<input checked="" type="checkbox"/>	<input checked="" type="checkbox"/>	<input type="checkbox"/>	<input checked="" type="checkbox"/> A	<input type="checkbox"/> B
Right	<input type="checkbox"/>	<input type="checkbox"/>	<input checked="" type="checkbox"/>	<input checked="" type="checkbox"/>	<input type="checkbox"/>	<input checked="" type="checkbox"/> A	<input type="checkbox"/> B
Top	<input type="checkbox"/>	<input type="checkbox"/>	<input checked="" type="checkbox"/>	<input checked="" type="checkbox"/>	<input type="checkbox"/>	<input checked="" type="checkbox"/> A	<input type="checkbox"/> B
Bottom	<input type="checkbox"/>	<input type="checkbox"/>	<input type="checkbox"/>	<input type="checkbox"/>	<input type="checkbox"/>	<input type="checkbox"/> A	<input type="checkbox"/> B

Discharge To Horizontal Coupling Plane							
Side of EUT	Test Levels			Results			
	± 2 kV	± 4 kV	± 6 kV	Pass	Fail	Performance Criterion	
Front	<input type="checkbox"/>	<input type="checkbox"/>	<input checked="" type="checkbox"/>	<input checked="" type="checkbox"/>	<input type="checkbox"/>	<input checked="" type="checkbox"/> A	<input type="checkbox"/> B
Back	<input type="checkbox"/>	<input type="checkbox"/>	<input checked="" type="checkbox"/>	<input checked="" type="checkbox"/>	<input type="checkbox"/>	<input checked="" type="checkbox"/> A	<input type="checkbox"/> B
Left	<input type="checkbox"/>	<input type="checkbox"/>	<input checked="" type="checkbox"/>	<input checked="" type="checkbox"/>	<input type="checkbox"/>	<input checked="" type="checkbox"/> A	<input type="checkbox"/> B
Right	<input type="checkbox"/>	<input type="checkbox"/>	<input checked="" type="checkbox"/>	<input checked="" type="checkbox"/>	<input type="checkbox"/>	<input checked="" type="checkbox"/> A	<input type="checkbox"/> B

Discharge To Vertical Coupling Plane							
Side of EUT	Test Levels			Results			
	± 2 kV	± 4 kV	± 6 kV	Pass	Fail	Performance Criterion	
Front	<input type="checkbox"/>	<input type="checkbox"/>	<input checked="" type="checkbox"/>	<input checked="" type="checkbox"/>	<input type="checkbox"/>	<input checked="" type="checkbox"/> A	<input type="checkbox"/> B
Back	<input type="checkbox"/>	<input type="checkbox"/>	<input checked="" type="checkbox"/>	<input checked="" type="checkbox"/>	<input type="checkbox"/>	<input checked="" type="checkbox"/> A	<input type="checkbox"/> B
Left	<input type="checkbox"/>	<input type="checkbox"/>	<input checked="" type="checkbox"/>	<input checked="" type="checkbox"/>	<input type="checkbox"/>	<input checked="" type="checkbox"/> A	<input type="checkbox"/> B
Right	<input type="checkbox"/>	<input type="checkbox"/>	<input checked="" type="checkbox"/>	<input checked="" type="checkbox"/>	<input type="checkbox"/>	<input checked="" type="checkbox"/> A	<input type="checkbox"/> B

The Photo for Discharge Points of EUT

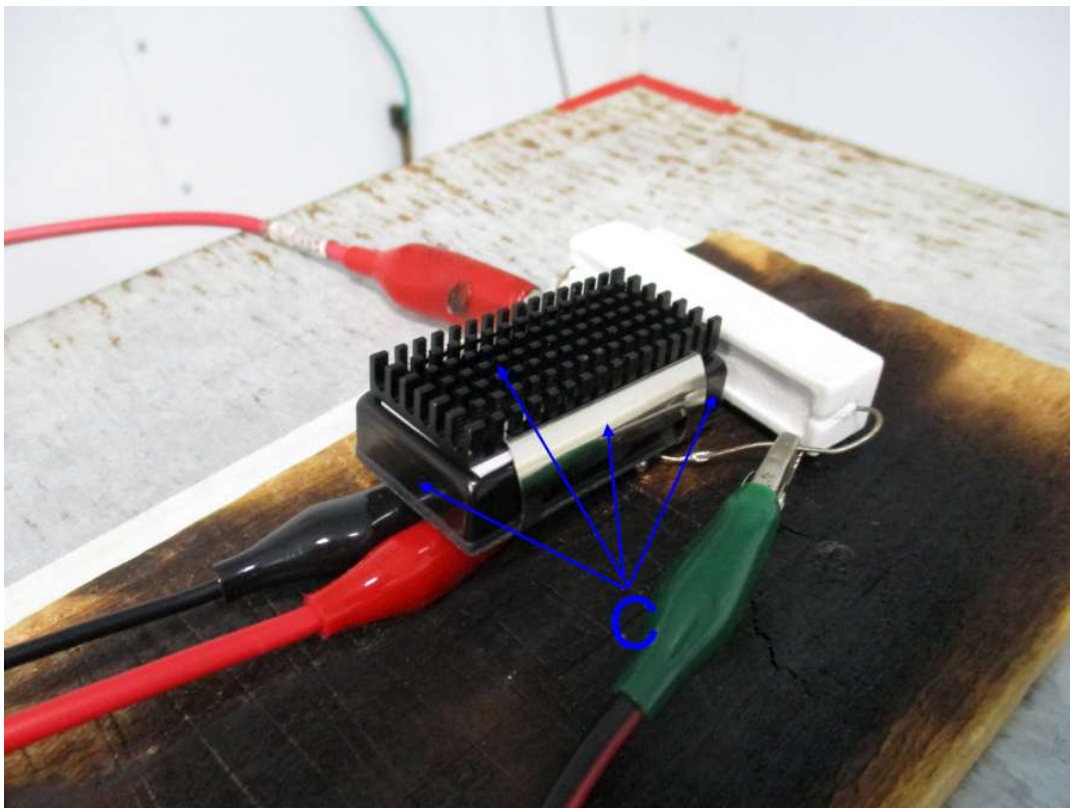
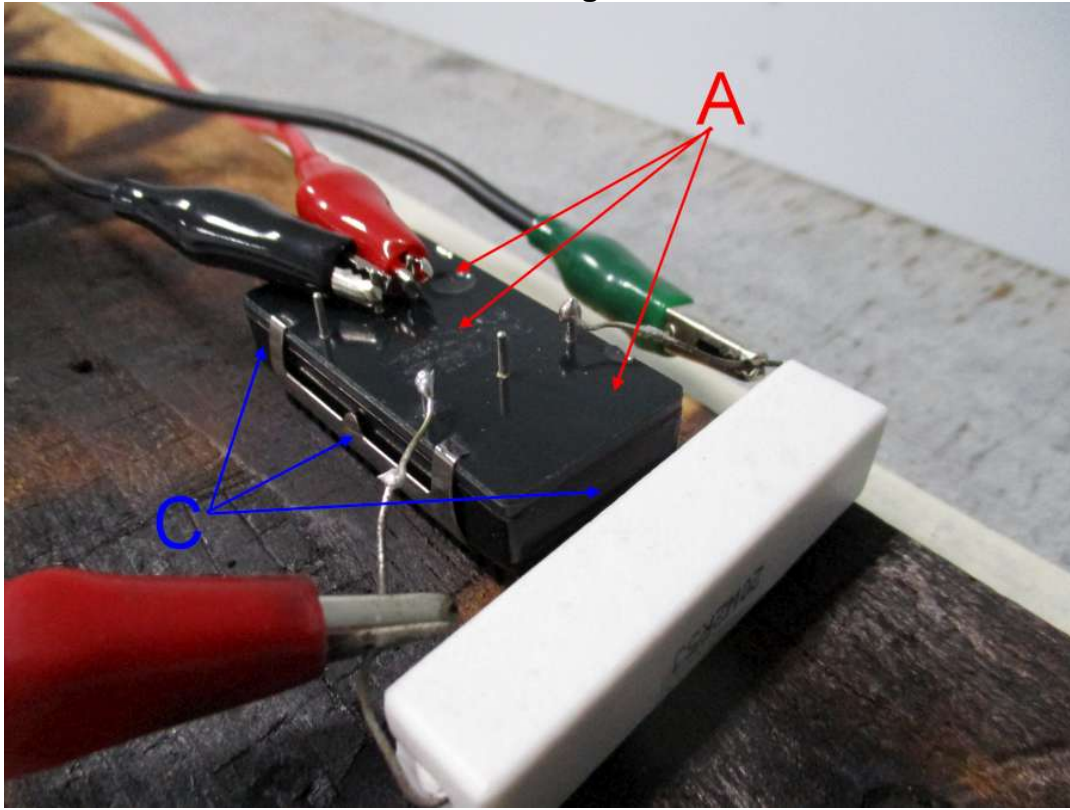

'A' Mark — Air Discharged ;
'C' Mark —Contact Discharged

Model: ERM04A18-HS

Temperature	23°C	Humidity	45% RH
Pressure	1028mbar	Tested By	Taiyu Cyu
Required Passing Performance		Criterion B	

Air Discharge							
Test Points	Test Levels			Results			
	± 2 kV	± 4 kV	± 8 kV	Pass	Fail	Performance Criterion	
Front	<input type="checkbox"/>	<input type="checkbox"/>	<input type="checkbox"/>	<input type="checkbox"/>	<input type="checkbox"/>	<input type="checkbox"/> A	<input type="checkbox"/> B
Back	<input type="checkbox"/>	<input type="checkbox"/>	<input type="checkbox"/>	<input type="checkbox"/>	<input type="checkbox"/>	<input type="checkbox"/> A	<input type="checkbox"/> B
Left	<input type="checkbox"/>	<input type="checkbox"/>	<input type="checkbox"/>	<input type="checkbox"/>	<input type="checkbox"/>	<input type="checkbox"/> A	<input type="checkbox"/> B
Right	<input type="checkbox"/>	<input type="checkbox"/>	<input type="checkbox"/>	<input type="checkbox"/>	<input type="checkbox"/>	<input type="checkbox"/> A	<input type="checkbox"/> B
Top	<input type="checkbox"/>	<input type="checkbox"/>	<input type="checkbox"/>	<input type="checkbox"/>	<input type="checkbox"/>	<input type="checkbox"/> A	<input type="checkbox"/> B
Bottom	<input checked="" type="checkbox"/>	<input checked="" type="checkbox"/>	<input checked="" type="checkbox"/>	<input checked="" type="checkbox"/>	<input type="checkbox"/>	<input checked="" type="checkbox"/> A	<input type="checkbox"/> B

Contact Discharge							
Test Points	Test Levels			Results			
	± 2 kV	± 4 kV	± 8 kV	Pass	Fail	Performance Criterion	
Front	<input type="checkbox"/>	<input checked="" type="checkbox"/>	<input type="checkbox"/>	<input checked="" type="checkbox"/>	<input type="checkbox"/>	<input checked="" type="checkbox"/> A	<input type="checkbox"/> B
Back	<input type="checkbox"/>	<input checked="" type="checkbox"/>	<input type="checkbox"/>	<input checked="" type="checkbox"/>	<input type="checkbox"/>	<input checked="" type="checkbox"/> A	<input type="checkbox"/> B
Left	<input type="checkbox"/>	<input checked="" type="checkbox"/>	<input type="checkbox"/>	<input checked="" type="checkbox"/>	<input type="checkbox"/>	<input checked="" type="checkbox"/> A	<input type="checkbox"/> B
Right	<input type="checkbox"/>	<input checked="" type="checkbox"/>	<input type="checkbox"/>	<input checked="" type="checkbox"/>	<input type="checkbox"/>	<input checked="" type="checkbox"/> A	<input type="checkbox"/> B
Top	<input type="checkbox"/>	<input checked="" type="checkbox"/>	<input type="checkbox"/>	<input checked="" type="checkbox"/>	<input type="checkbox"/>	<input checked="" type="checkbox"/> A	<input type="checkbox"/> B
Bottom	<input type="checkbox"/>	<input type="checkbox"/>	<input type="checkbox"/>	<input type="checkbox"/>	<input type="checkbox"/>	<input type="checkbox"/> A	<input type="checkbox"/> B

Discharge To Horizontal Coupling Plane							
Side of EUT	Test Levels			Results			
	± 2 kV	± 4 kV	± 6 kV	Pass	Fail	Performance Criterion	
Front	<input type="checkbox"/>	<input checked="" type="checkbox"/>	<input type="checkbox"/>	<input checked="" type="checkbox"/>	<input type="checkbox"/>	<input checked="" type="checkbox"/> A	<input type="checkbox"/> B
Back	<input type="checkbox"/>	<input checked="" type="checkbox"/>	<input type="checkbox"/>	<input checked="" type="checkbox"/>	<input type="checkbox"/>	<input checked="" type="checkbox"/> A	<input type="checkbox"/> B
Left	<input type="checkbox"/>	<input checked="" type="checkbox"/>	<input type="checkbox"/>	<input checked="" type="checkbox"/>	<input type="checkbox"/>	<input checked="" type="checkbox"/> A	<input type="checkbox"/> B
Right	<input type="checkbox"/>	<input checked="" type="checkbox"/>	<input type="checkbox"/>	<input checked="" type="checkbox"/>	<input type="checkbox"/>	<input checked="" type="checkbox"/> A	<input type="checkbox"/> B

Discharge To Vertical Coupling Plane							
Side of EUT	Test Levels			Results			
	± 2 kV	± 4 kV	± 6 kV	Pass	Fail	Performance Criterion	
Front	<input type="checkbox"/>	<input checked="" type="checkbox"/>	<input type="checkbox"/>	<input checked="" type="checkbox"/>	<input type="checkbox"/>	<input checked="" type="checkbox"/> A	<input type="checkbox"/> B
Back	<input type="checkbox"/>	<input checked="" type="checkbox"/>	<input type="checkbox"/>	<input checked="" type="checkbox"/>	<input type="checkbox"/>	<input checked="" type="checkbox"/> A	<input type="checkbox"/> B
Left	<input type="checkbox"/>	<input checked="" type="checkbox"/>	<input type="checkbox"/>	<input checked="" type="checkbox"/>	<input type="checkbox"/>	<input checked="" type="checkbox"/> A	<input type="checkbox"/> B
Right	<input type="checkbox"/>	<input checked="" type="checkbox"/>	<input type="checkbox"/>	<input checked="" type="checkbox"/>	<input type="checkbox"/>	<input checked="" type="checkbox"/> A	<input type="checkbox"/> B

For Strict Test

Temperature	23°C	Humidity	45% RH
Pressure	1028mbar	Tested By	Taiyu Cyu
Required Passing Performance		Criterion B	

Air Discharge							
Test Points	Test Levels			Results			
	± 2 kV	± 4 kV	± 8 kV	Pass	Fail	Performance Criterion	
Front	<input type="checkbox"/>	<input type="checkbox"/>	<input type="checkbox"/>	<input type="checkbox"/>	<input type="checkbox"/>	<input type="checkbox"/> A	<input type="checkbox"/> B
Back	<input type="checkbox"/>	<input type="checkbox"/>	<input type="checkbox"/>	<input type="checkbox"/>	<input type="checkbox"/>	<input type="checkbox"/> A	<input type="checkbox"/> B
Left	<input type="checkbox"/>	<input type="checkbox"/>	<input type="checkbox"/>	<input type="checkbox"/>	<input type="checkbox"/>	<input type="checkbox"/> A	<input type="checkbox"/> B
Right	<input type="checkbox"/>	<input type="checkbox"/>	<input type="checkbox"/>	<input type="checkbox"/>	<input type="checkbox"/>	<input type="checkbox"/> A	<input type="checkbox"/> B
Top	<input type="checkbox"/>	<input type="checkbox"/>	<input type="checkbox"/>	<input type="checkbox"/>	<input type="checkbox"/>	<input type="checkbox"/> A	<input type="checkbox"/> B
Bottom	<input checked="" type="checkbox"/>	<input checked="" type="checkbox"/>	<input checked="" type="checkbox"/>	<input checked="" type="checkbox"/>	<input type="checkbox"/>	<input checked="" type="checkbox"/> A	<input type="checkbox"/> B

Contact Discharge							
Test Points	Test Levels			Results			
	± 2 kV	± 4 kV	± 6 kV	Pass	Fail	Performance Criterion	
Front	<input type="checkbox"/>	<input type="checkbox"/>	<input checked="" type="checkbox"/>	<input checked="" type="checkbox"/>	<input type="checkbox"/>	<input checked="" type="checkbox"/> A	<input type="checkbox"/> B
Back	<input type="checkbox"/>	<input type="checkbox"/>	<input checked="" type="checkbox"/>	<input checked="" type="checkbox"/>	<input type="checkbox"/>	<input checked="" type="checkbox"/> A	<input type="checkbox"/> B
Left	<input type="checkbox"/>	<input type="checkbox"/>	<input checked="" type="checkbox"/>	<input checked="" type="checkbox"/>	<input type="checkbox"/>	<input checked="" type="checkbox"/> A	<input type="checkbox"/> B
Right	<input type="checkbox"/>	<input type="checkbox"/>	<input checked="" type="checkbox"/>	<input checked="" type="checkbox"/>	<input type="checkbox"/>	<input checked="" type="checkbox"/> A	<input type="checkbox"/> B
Top	<input type="checkbox"/>	<input type="checkbox"/>	<input checked="" type="checkbox"/>	<input checked="" type="checkbox"/>	<input type="checkbox"/>	<input checked="" type="checkbox"/> A	<input type="checkbox"/> B
Bottom	<input type="checkbox"/>	<input type="checkbox"/>	<input type="checkbox"/>	<input type="checkbox"/>	<input type="checkbox"/>	<input type="checkbox"/> A	<input type="checkbox"/> B

Discharge To Horizontal Coupling Plane							
Side of EUT	Test Levels			Results			
	± 2 kV	± 4 kV	± 6 kV	Pass	Fail	Performance Criterion	
Front	<input type="checkbox"/>	<input type="checkbox"/>	<input checked="" type="checkbox"/>	<input checked="" type="checkbox"/>	<input type="checkbox"/>	<input checked="" type="checkbox"/> A	<input type="checkbox"/> B
Back	<input type="checkbox"/>	<input type="checkbox"/>	<input checked="" type="checkbox"/>	<input checked="" type="checkbox"/>	<input type="checkbox"/>	<input checked="" type="checkbox"/> A	<input type="checkbox"/> B
Left	<input type="checkbox"/>	<input type="checkbox"/>	<input checked="" type="checkbox"/>	<input checked="" type="checkbox"/>	<input type="checkbox"/>	<input checked="" type="checkbox"/> A	<input type="checkbox"/> B
Right	<input type="checkbox"/>	<input type="checkbox"/>	<input checked="" type="checkbox"/>	<input checked="" type="checkbox"/>	<input type="checkbox"/>	<input checked="" type="checkbox"/> A	<input type="checkbox"/> B

Discharge To Vertical Coupling Plane							
Side of EUT	Test Levels			Results			
	± 2 kV	± 4 kV	± 6 kV	Pass	Fail	Performance Criterion	
Front	<input type="checkbox"/>	<input type="checkbox"/>	<input checked="" type="checkbox"/>	<input checked="" type="checkbox"/>	<input type="checkbox"/>	<input checked="" type="checkbox"/> A	<input type="checkbox"/> B
Back	<input type="checkbox"/>	<input type="checkbox"/>	<input checked="" type="checkbox"/>	<input checked="" type="checkbox"/>	<input type="checkbox"/>	<input checked="" type="checkbox"/> A	<input type="checkbox"/> B
Left	<input type="checkbox"/>	<input type="checkbox"/>	<input checked="" type="checkbox"/>	<input checked="" type="checkbox"/>	<input type="checkbox"/>	<input checked="" type="checkbox"/> A	<input type="checkbox"/> B
Right	<input type="checkbox"/>	<input type="checkbox"/>	<input checked="" type="checkbox"/>	<input checked="" type="checkbox"/>	<input type="checkbox"/>	<input checked="" type="checkbox"/> A	<input type="checkbox"/> B

The Photo for Discharge Points of EUT

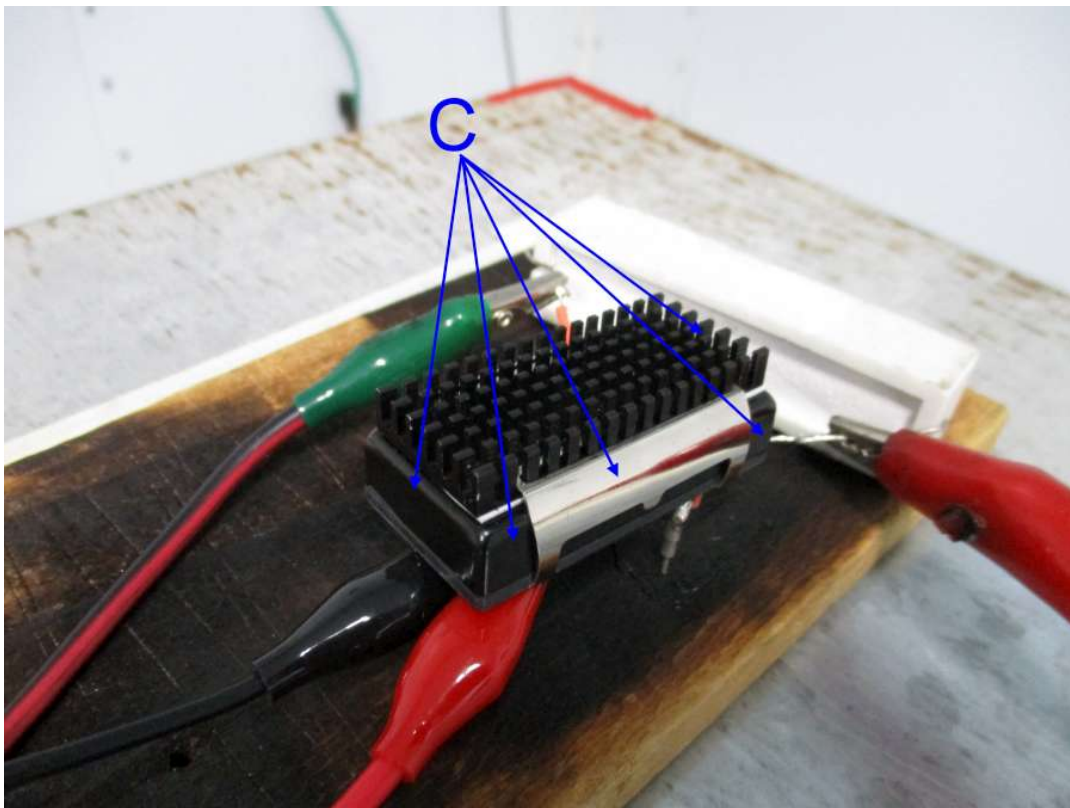
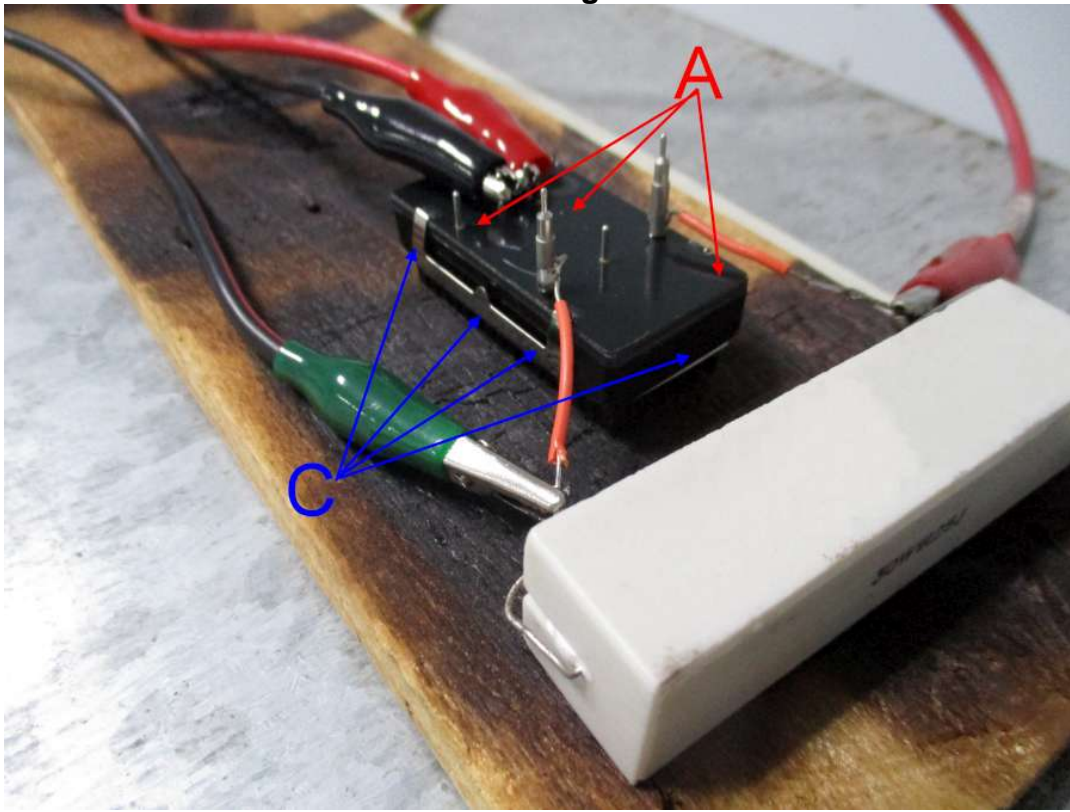

'A' Mark — Air Discharged ;
'C' Mark —Contact Discharged

8.4. RADIATED, RADIO-FREQUENCY, ELECTROMAGNETIC FIELD (RS)

8.4.1. TEST SPECIFICATION

Basic Standard: IEC 61000-4-3
Frequency Range: 80 MHz ~ 1000 MHz
Field Strength: 10 V/m
Modulation: 1kHz Sine Wave, 80%, AM Modulation
Frequency Step: 1 % of preceding frequency value
Polarity of Antenna: Horizontal and Vertical
Test Distance: 3 m
Antenna Height: 1.5m

8.4.2. TEST INSTRUMENT

966 RS Chamber				
Name of Equipment	Manufacturer	Model	Serial Number	Calibration Due
Amplifier	ar	60S1G3M3 60Watt	310102	N.C.R
Amplifier	ar	150W1000M3	310037	N.C.R
Antenna	ar	AT5080	309817	N.C.R
Digital Signal Generator	HP	ESG-D3000A	US36260655	04/20/2017
Power SENSOR	Boonton	51011-EMC	33428	04/21/2017
Power SENSOR	Boonton	51011-EMC	33429	04/21/2017
RS Power Meter	Boonton	4232A-01-02	122202	04/21/2017
Software	RS SW1005 R1_4			

Note: 1. The calibration interval of the above test instruments is 12 months and the calibrations are traceable to NML/ROC and NIST/USA.
 2. N.C.R. = No Calibration required

8.4.3. TEST PROCEDURE

The test procedure was in accordance with IEC 61000-4-3

- The testing was performed in a fully anechoic chamber. The transmit antenna was located at a distance of 3 meters from the EUT.
- The frequency range is swept from 80 MHz to 1000 MHz, with the signal 80% amplitude modulated with a 1kHz sine-wave. The rate of sweep did not exceed 1.5×10^{-3} decade/s, where the frequency range is swept incrementally, the step size was 1% of preceding frequency value.
- The dwell time at each frequency shall be not less than the time necessary for the EUT to be able to respond.
- The test was performed with the EUT exposed to both vertically and horizontally polarized fields on each of the four sides.

8.4.4. TEST SETUP

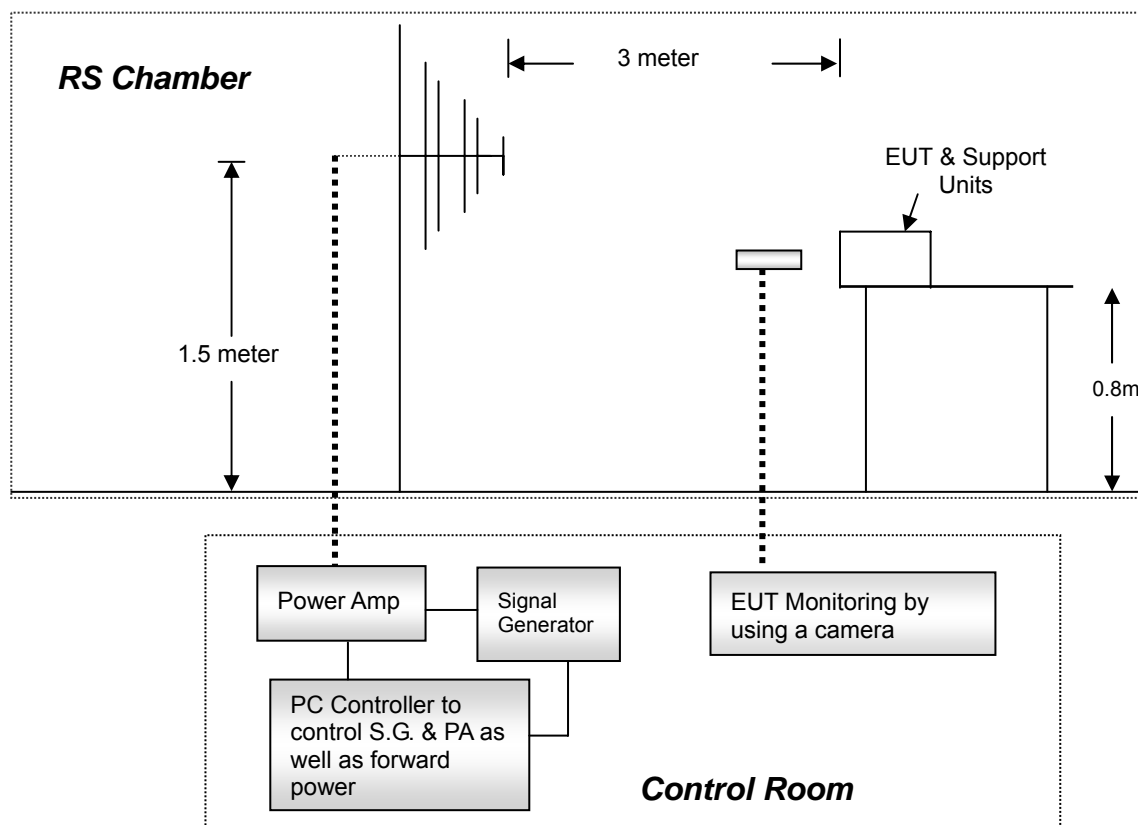

For the actual test configuration, please refer to the related item - Photographs of the Test Configuration.

Note:

TABLETOP EQUIPMENT

The EUT installed in a representative system as described in section 7 of IEC 61000-4-3 was placed on a non-conductive table 0.8 meters in height. The system under test was connected to the power and signal wire according to relevant installation instructions.

FLOOR-STANDING EQUIPMENT

The EUT installed in a representative system as described in section 7 of IEC 61000-4-3 was placed on a non-conductive wood support 0.1 meters in height. The system under test was connected to the power and signal wire according to relevant installation instructions.

8.4.5. TEST RESULTS

Model: ERM02A18-HS

Temperature	24°C	Humidity	46% RH
Pressure	1028mbar	Dwell Time	3 sec.
Tested By	Taiyu Cyu	Required Passing Performance	Criterion A

Frequency (MHz)	Polarity	Azimuth	Field Strength (V/m)	Performance Criterion	Result	Observation
80 ~ 1000	V&H	0	3	<input checked="" type="checkbox"/> A <input type="checkbox"/> B	PASS	
80 ~ 1000	V&H	90	3	<input checked="" type="checkbox"/> A <input type="checkbox"/> B	PASS	
80 ~ 1000	V&H	180	3	<input checked="" type="checkbox"/> A <input type="checkbox"/> B	PASS	
80 ~ 1000	V&H	270	3	<input checked="" type="checkbox"/> A <input type="checkbox"/> B	PASS	

For Strict Test

Frequency (MHz)	Polarity	Azimuth	Field Strength (V/m)	Performance Criterion	Result	Observation
80 ~ 1000	V&H	0	10	<input checked="" type="checkbox"/> A <input type="checkbox"/> B	PASS	
80 ~ 1000	V&H	90	10	<input checked="" type="checkbox"/> A <input type="checkbox"/> B	PASS	
80 ~ 1000	V&H	180	10	<input checked="" type="checkbox"/> A <input type="checkbox"/> B	PASS	
80 ~ 1000	V&H	270	10	<input checked="" type="checkbox"/> A <input type="checkbox"/> B	PASS	

Model: ERM04A18-HS

Temperature	24°C	Humidity	46% RH
Pressure	1028mbar	Dwell Time	3 sec.
Tested By	Taiyu Cyu	Required Passing Performance	Criterion A

Frequency (MHz)	Polarity	Azimuth	Field Strength (V/m)	Performance Criterion	Result	Observation
80 ~ 1000	V&H	0	3	<input checked="" type="checkbox"/> A <input type="checkbox"/> B	PASS	
80 ~ 1000	V&H	90	3	<input checked="" type="checkbox"/> A <input type="checkbox"/> B	PASS	
80 ~ 1000	V&H	180	3	<input checked="" type="checkbox"/> A <input type="checkbox"/> B	PASS	
80 ~ 1000	V&H	270	3	<input checked="" type="checkbox"/> A <input type="checkbox"/> B	PASS	

For Strict Test

Frequency (MHz)	Polarity	Azimuth	Field Strength (V/m)	Performance Criterion	Result	Observation
80 ~ 1000	V&H	0	10	<input checked="" type="checkbox"/> A <input type="checkbox"/> B	PASS	
80 ~ 1000	V&H	90	10	<input checked="" type="checkbox"/> A <input type="checkbox"/> B	PASS	
80 ~ 1000	V&H	180	10	<input checked="" type="checkbox"/> A <input type="checkbox"/> B	PASS	
80 ~ 1000	V&H	270	10	<input checked="" type="checkbox"/> A <input type="checkbox"/> B	PASS	

8.5. ELECTRICAL FAST TRANSIENT (EFT)

8.5.1. TEST SPECIFICATION

Basic Standard:	IEC 61000-4-4
Test Voltage:	AC Power Port: ---kV DC Power Port: 2kV Signal Ports and Telecommunication Ports: ---kV
Polarity:	Positive & Negative
Impulse Frequency:	5 kHz
Impulse Wave-shape:	5/50 ns
Burst Duration:	15 ms
Burst Period:	300 ms
Test Duration:	Not less than 1 min.

8.5.2. TEST INSTRUMENT

Immunity Shield Room				
Name of Equipment	Manufacturer	Model	Serial Number	Calibration Due
Capacitor Clamp	KeyTek	CCL-4	9306412	01/17/2017
EMS Test System	KeyTek	EMCpro	0312231	11/19/2016
Software	CE Ware 3.00b			

Note:

1. The calibration interval of the above test instruments is 12 months and the calibrations are traceable to NML/ROC and NIST/USA.
2. N.C.R.= No Calibration required

8.5.3. TEST PROCEDURE

- a) Both positive and negative polarity discharges were applied.
- b) The length of the “hot wire” from the coaxial output of the EFT generator to the terminals on the EUT should not exceed 0.5 meter.
- c) The duration time of each test sequential was 1 minute.
- d) The transient/burst waveform was in accordance with IEC 61000-4-4, 5/50ns.

8.5.4. TEST SETUP

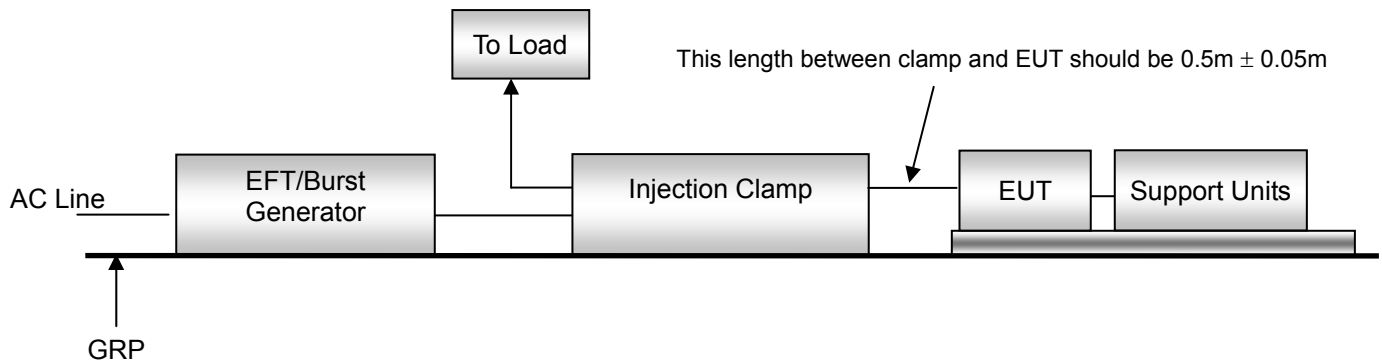
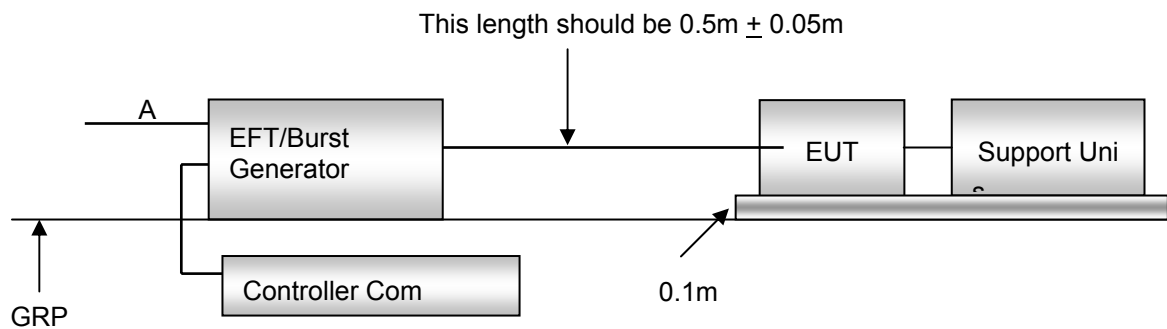

For the actual test configuration, please refer to the related item - Photographs of the Test Configuration.

Note:

TABLETOP EQUIPMENT

The configuration consisted of a wooden table (0.1m high) standing on the Ground Reference Plane. The GRP consisted of a sheet of aluminum (at least 0.25mm thick and 2.5m square) connected to the protective grounding system. A minimum distance of 0.5m was provided between the EUT and the walls of the laboratory or any other metallic structure.

FLOOR-STANDING EQUIPMENT

The EUT installed in a representative system as described in section 7 of IEC 61000-4-4 and its cables, were isolated from the Ground Reference Plane by an insulating support that is 0.1-meter thick. The GRP consisted of a sheet of aluminum (at least 0.25mm thick and 2.5m square) connected to the protective grounding system.

8.5.5. TEST RESULTS

Model: ERM02A18-HS

Temperature	24°C	Humidity	46% RH
Pressure	1028mbar	Tested By	Taiyu Cyu
Required Passing Performance		Criterion B	

Test Point	Polarity	Test Level (kV)	Performance Criterion	Result	Observation
L1	+/-	0.5	<input checked="" type="checkbox"/> A <input type="checkbox"/> B	PASS	
L2	+/-	0.5	<input checked="" type="checkbox"/> A <input type="checkbox"/> B	PASS	
L1 + L2	+/-	0.5	<input checked="" type="checkbox"/> A <input type="checkbox"/> B	PASS	

For Strict Test:

Test Point	Polarity	Test Level (kV)	Performance Criterion	Result	Observation
L1	+/-	2	<input checked="" type="checkbox"/> A <input type="checkbox"/> B	PASS	
L2	+/-	2	<input checked="" type="checkbox"/> A <input type="checkbox"/> B	PASS	
L1 + L2	+/-	2	<input checked="" type="checkbox"/> A <input type="checkbox"/> B	PASS	

Model: ERM04A18-HS

Temperature	24°C	Humidity	46% RH
Pressure	1028mbar	Tested By	Taiyu Cyu
Required Passing Performance		Criterion B	

Test Point	Polarity	Test Level (kV)	Performance Criterion	Result	Observation
L1	+/-	0.5	<input checked="" type="checkbox"/> A <input type="checkbox"/> B	PASS	
L2	+/-	0.5	<input checked="" type="checkbox"/> A <input type="checkbox"/> B	PASS	
L1 + L2	+/-	0.5	<input checked="" type="checkbox"/> A <input type="checkbox"/> B	PASS	

For Strict Test:

Test Point	Polarity	Test Level (kV)	Performance Criterion	Result	Observation
L1	+/-	2	<input checked="" type="checkbox"/> A <input type="checkbox"/> B	PASS	
L2	+/-	2	<input checked="" type="checkbox"/> A <input type="checkbox"/> B	PASS	
L1 + L2	+/-	2	<input checked="" type="checkbox"/> A <input type="checkbox"/> B	PASS	

8.6. SURGE IMMUNITY TEST

8.6.1. TEST SPECIFICATION

Basic Standard:	IEC 61000-4-5
Wave-Shape:	Combination Wave 1.2/50 μ s Open Circuit Voltage 8/20 μ s Short Circuit Current
Test Voltage:	AC Power Port~ line to line: ---kV, line to ground: ---kV DC Power Port~ line to earth: 2kV Signal and Telecommunication Ports ~ line to ground: --kV
Surge Input/Output:	Power Line: L1 - L2
Generator Source Impedance:	2 ohm between networks 12 ohm between network and ground
Polarity:	Positive/Negative
Phase Angle:	0° / 90° / 180° / 270°
Pulse Repetition Rate:	1 time / min. (maximum)
Number of Tests:	5 positive and 5 negative at selected points

8.6.2. TEST INSTRUMENT

Immunity Shield Room				
Name of Equipment	Manufacturer	Model	Serial Number	Calibration Due
CDN	EMC-PAPTNER	CDN-UTP8	CDN-UTP8-1504	11/26/2016
EMS Test System	KeyTek	EMCpro	0312231	11/19/2016
Software	CE Ware 3.00b			

Note:

1. The calibration interval of the above test instruments is 12 months and the calibrations are traceable to NML/ROC and NIST/USA.
2. N.C.R.= No Calibration required

8.6.3. TEST PROCEDURE

a) For EUT power supply:

The surge is applied to the EUT power supply terminals via the capacitive coupling network. Decoupling networks are required in order to avoid possible adverse effects on equipment not under test that may be powered by the same lines, and to provide sufficient decoupling impedance to the surge wave. The power cord between the EUT and the coupling/decoupling networks was shorter than 2 meters in length.

b) For test applied to unshielded un-symmetrically operated interconnection lines of EUT:

The surge was applied to the lines via the capacitive coupling. The coupling / decoupling networks didn't influence the specified functional conditions of the EUT. The interconnection line between the EUT and the coupling/decoupling networks was shorter than 2 meters in length.

c) For test applied to unshielded symmetrically operated interconnection / telecommunication lines of EUT:

The surge was applied to the lines via gas arrestors coupling. Test levels below the ignition point of the coupling arrestor were not specified. The interconnection line between the EUT and the coupling/decoupling networks was shorter than 2 meters in length.

8.6.4. TEST SETUP

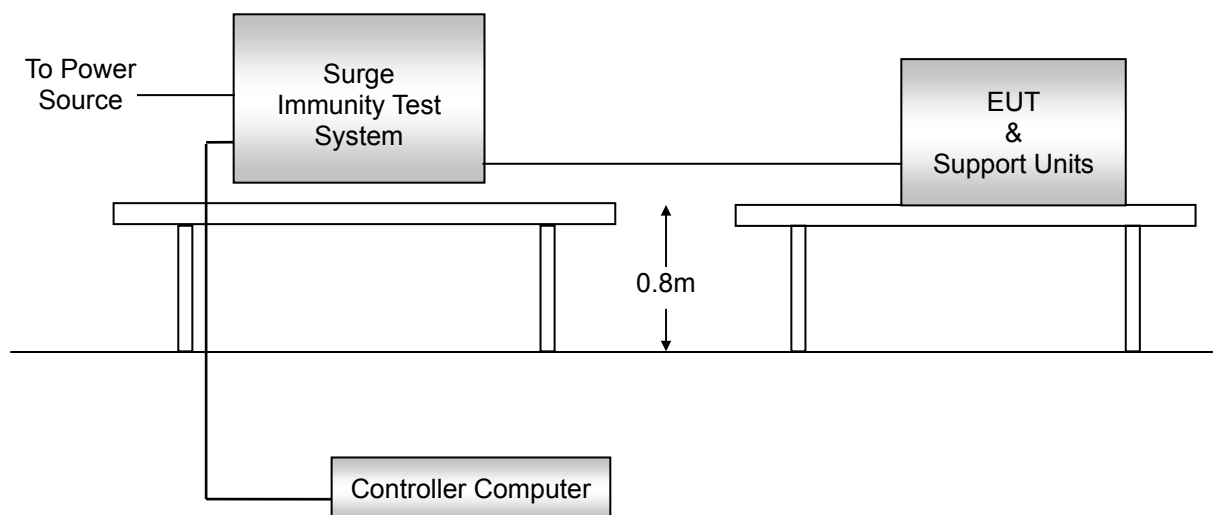

For the actual test configuration, please refer to the related item – Photographs of the Test Configuration.

8.6.5. TEST RESULTS

Model: ERM02A18-HS

Temperature	24°C	Humidity	45% RH
Pressure	1028mbar	Tested By	Taiyu Cyu
Required Passing Performance		Criterion B	

Test Point	Polarity	Test Level (kV)	Performance Criterion	Result	Observation
L1 - L2	+/-	0.5	<input checked="" type="checkbox"/> A <input type="checkbox"/> B	PASS	

For Strict Test:

Test Point	Polarity	Test Level (kV)	Performance Criterion	Result	Observation
L1 - L2	+/-	2	<input checked="" type="checkbox"/> A <input type="checkbox"/> B	PASS	

Model: ERM04A18-HS

Temperature	24°C	Humidity	45% RH
Pressure	1028mbar	Tested By	Taiyu Cyu
Required Passing Performance		Criterion B	

Test Point	Polarity	Test Level (kV)	Performance Criterion	Result	Observation
L1 - L2	+/-	0.5	<input checked="" type="checkbox"/> A <input type="checkbox"/> B	PASS	

For Strict Test:

Test Point	Polarity	Test Level (kV)	Performance Criterion	Result	Observation
L1 - L2	+/-	2	<input checked="" type="checkbox"/> A <input type="checkbox"/> B	PASS	

8.7. CONDUCTED RADIO FREQUENCY DISTURBANCES (CS)

8.7.1. TEST SPECIFICATION

Basic Standard: IEC 61000-4-6

Frequency Range: 0.15 MHz ~ 80 MHz

Field Strength: 10Vrms

Modulation: 1kHz Sine Wave, 80%, AM Modulation

Frequency Step: 1 % of preceding frequency value

Coupling device: CDN-M2 (2 wires)

8.7.2. TEST INSTRUMENT

CS Test Site (IEC/EN 61000-4-6)				
Name of Equipment	Manufacturer	Model	Serial Number	Calibration Due
6dB Attenuator	BIRD	75-A-FFN-06	0346	N.C.R
CDN	Frankonia	CDN M2+M3	A3011095	12/06/2016
Conduction Immunity	Frankonia	CIT-10/75	102C3220	04/26/2017
Couplihd/Decoupling Networks	FRANKONIA	CDN-RJ45	A3100030/2013	04/27/2017
EM Injection Clamp	FCC	F-203I-23MM	449	05/03/2017
Software	CS-EN61000-4-6			

Note:

1. The calibration interval of the above test instruments is 12 months and the calibrations are traceable to NML/ROC and NIST/USA.
2. N.C.R.= No Calibration required

8.7.3. TEST PROCEDURE

The EUT shall be tested within its intended operating and climatic conditions.

The test shall be performed with the test generator connected to each of the coupling and decoupling devices in turn, while the other non-excited RF input ports of the coupling devices are terminated by a 50-ohm load resistor.

The frequency range was swept from 150 kHz to 80 MHz, using the signal level established during the setting process and with a disturbance signal of 80 % amplitude. The signal was modulated with a 1 kHz sine wave, pausing to adjust the RF signal level or the switch coupling devices as necessary. The sweep rate was 1.5×10^{-3} decades/s. Where the frequency range is swept incrementally, the step size was 1 % of preceding frequency value from 150 kHz to 80 MHz.

The dwell time at each frequency was less than the time necessary for the EUT to be exercised, and able to respond. Sensitive frequencies such as clock frequency(ies) and harmonics or frequencies of dominant interest, was analyzed separately.

Attempts were made to fully exercise the EUT during testing, and to fully interrogate all exercise modes selected for susceptibility.

8.7.4. TEST SETUP

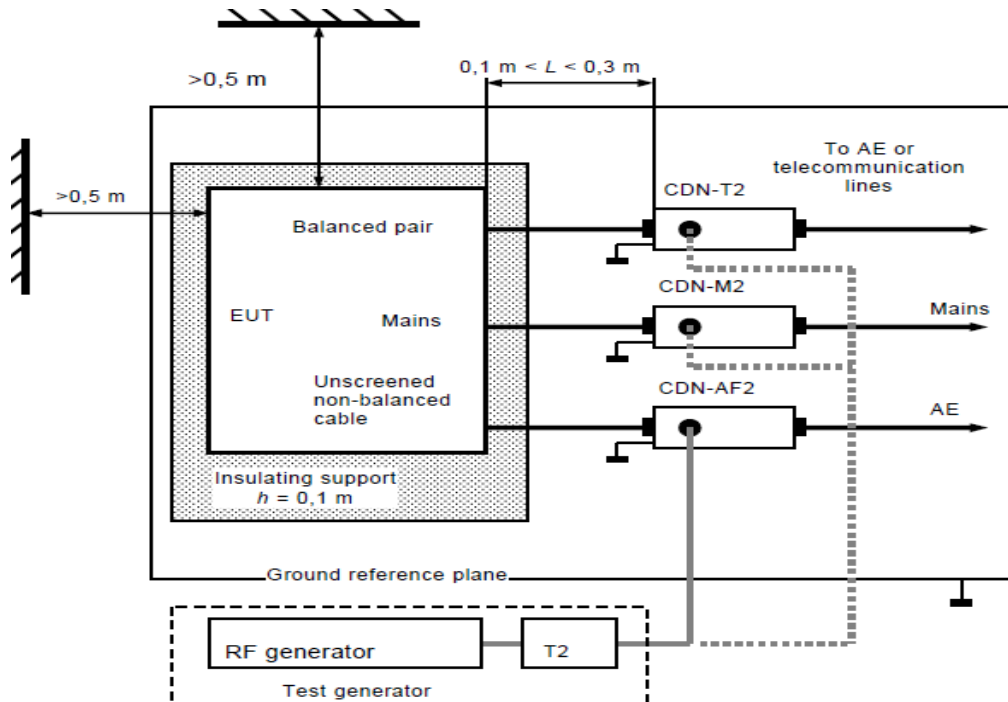

Note:

1. The EUT is setup 0.1m above Ground Reference Plane
2. The CDNs and / or EM clamp used for real test depend on ports and cables configuration of EUT.

For the actual test configuration, please refer to the related item – Photographs of the Test Configuration.

Note:

TABLETOP AND FLOOR-STANDING EQUIPMENT

The equipment to be tested is placed on an insulating support of 0.1 meters height above a ground reference plane. All relevant cables shall be provided with the appropriate coupling and decoupling devices at a distance between 0.1 meters and 0.3 meters from the projected geometry of the EUT on the ground reference plane.

8.7.5. TEST RESULTS

Model: ERM02A18-HS

Temperature	24°C	Humidity	44% RH
Pressure	1028mbar	Tested By	Taiyu Cyu
Required Passing Performance		Criterion A	

Frequency Band (MHz)	Field Strength (Vrms)	Cable	Injection Method	Performance Criterion	Result	Observation
0.15 ~ 80	3	DC Power	CDN-M2	<input checked="" type="checkbox"/> A <input type="checkbox"/> B	PASS	

For Strict Test:

Frequency Band (MHz)	Field Strength (Vrms)	Cable	Injection Method	Performance Criterion	Result	Observation
0.15 ~ 80	10	DC Power	CDN-M2	<input checked="" type="checkbox"/> A <input type="checkbox"/> B	PASS	

Model: ERM04A18-HS

Temperature	24°C	Humidity	44% RH
Pressure	1028mbar	Tested By	Taiyu Cyu
Required Passing Performance		Criterion A	

Frequency Band (MHz)	Field Strength (Vrms)	Cable	Injection Method	Performance Criterion	Result	Observation
0.15 ~ 80	3	DC Power	CDN-M2	<input checked="" type="checkbox"/> A <input type="checkbox"/> B	PASS	

For Strict Test:

Frequency Band (MHz)	Field Strength (Vrms)	Cable	Injection Method	Performance Criterion	Result	Observation
0.15 ~ 80	10	DC Power	CDN-M2	<input checked="" type="checkbox"/> A <input type="checkbox"/> B	PASS	

8.8. POWER FREQUENCY MAGNETIC FIELD

8.8.1. TEST SPECIFICATION

Basic Standard: IEC 61000-4-8

Frequency Range: 50Hz

Field Strength: 100 A/m

Observation Time: 1 minute

Inductance Coil: Rectangular type, 1mx1m

8.8.2. TEST INSTRUMENT

Tainan Lab.

Immunity Shield Room				
Name of Equipment	Manufacturer	Model	Serial Number	Calibration Due
AC/DC CLAMP METER	PROVA	2003	2190104	01/27/2017
Magnetic generator	Schaffner	MFO 6501	154	N.C.R
Magnetic loops	Schaffner	INA 702	158	N.C.R

Xindian Lab.

Immunity Shield Room				
Name of Equipment	Manufacturer	Model	Serial Number	Calibration Due
AC/DC Clamp Meter	Fluke	353	33360025	07/06/2017
Magnetic Field Coil	Teseq	INA 703 W/2141	1976/1413	04/21/2017
Magnetic Field Meter	Sypris	4080	0247	04/24/2017
5kVA Power Source	Teseq	5001IX-208-TSQ	1207A03643	N.C.R
Software	Win2120Ver. 5.0			

Note:

1. The calibration interval of the above test instruments is 12 months and the calibrations are traceable to NML/ROC and NIST/USA.
2. N.C.R.= No Calibration required

8.8.3. TEST PROCEDURE

- a) The equipment is configured and connected to satisfy its functional requirements. It shall be placed on the GRP with the interposition of a 0.1m-thick insulating support.
- b) The equipment cabinets shall be connected to the safety earth directly on the GRP via the earth terminal of the EUT.
- c) The power supply, input and output circuits shall be connected to the sources of power supply, control and signal.
- d) The cables supplied or recommended by the equipment manufacturer shall be used. 1 meter of all cables used shall be exposed to the magnetic field.

8.8.4. TEST SETUP

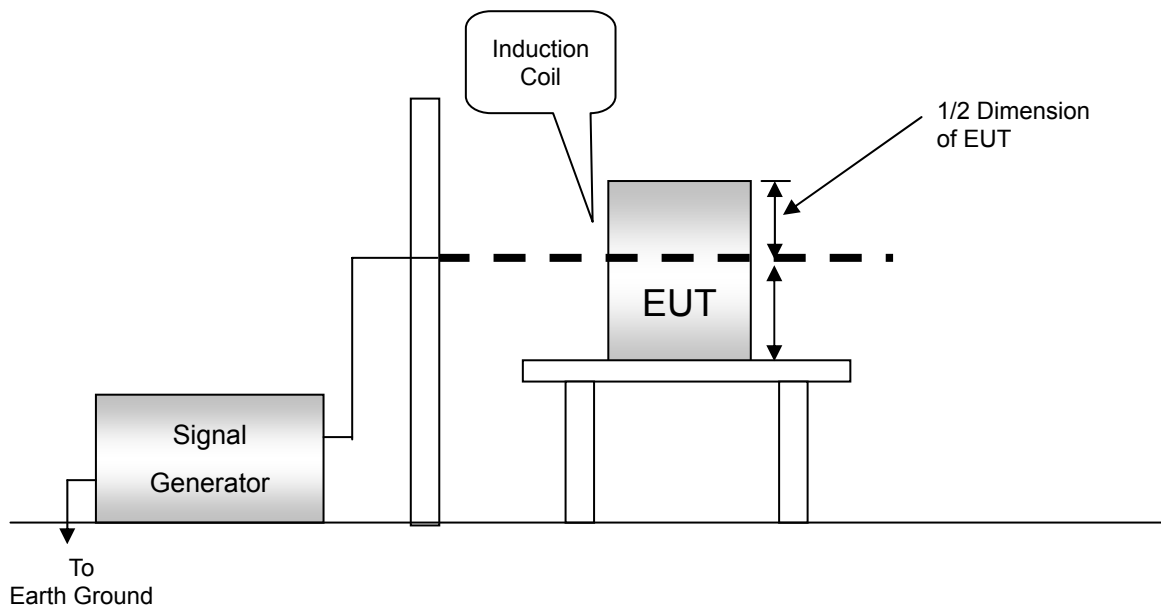

For the actual test configuration, please refer to the related item – Photographs of the Test Configuration.

Note:

TABLETOP EQUIPMENT

The equipment shall be subjected to the test magnetic field by using the induction coil of standard dimension (1 m x 1 m). The induction coil shall then be rotated by 90 degrees in order to expose the EUT to the test field with different orientations.

FLOOR-STANDING EQUIPMENT

The equipment shall be subjected to the test magnetic field by using induction coils of suitable dimensions. The test shall be repeated by moving and shifting the induction coils, in order to test the whole volume of the EUT for each orthogonal direction. The test shall be repeated with the coil shifted to different positions along the side of the EUT, in steps corresponding to 50 % of the shortest side of the coil. The induction coil shall then be rotated by 90 degrees in order to expose the EUT to the test field with different orientations.

8.8.5. TEST RESULTS

Tainan Lab.

Model: ERM02A18-HS

Temperature	24°C	Humidity	46% RH
Pressure	1028mbar	Tested By	Taiyu Cyu
Required Passing Performance		Criterion A	

DIRECTION	Field Strength (A/m)	Performance Criterion	Result	Observation
X	1	<input checked="" type="checkbox"/> A <input type="checkbox"/> B	PASS	
Y	1	<input checked="" type="checkbox"/> A <input type="checkbox"/> B	PASS	
Z	1	<input checked="" type="checkbox"/> A <input type="checkbox"/> B	PASS	

For Strict Test:

Xindian Lab.

Temperature	19°C	Humidity	55% RH
Pressure	1007	Tested By	PIPO
Required Passing Performance		Criterion A	

DIRECTION	Field Strength (A/m)	Performance Criterion	Result	Observation
X	100	<input checked="" type="checkbox"/> A <input type="checkbox"/> B	PASS	
Y	100	<input checked="" type="checkbox"/> A <input type="checkbox"/> B	PASS	
Z	100	<input checked="" type="checkbox"/> A <input type="checkbox"/> B	PASS	

Tainan Lab.

Model: ERM04A18-HS

Temperature	24°C	Humidity	46% RH
Pressure	1028mbar	Tested By	Taiyu Cyu
Required Passing Performance		Criterion A	

DIRECTION	Field Strength (A/m)	Performance Criterion	Result	Observation
X	1	<input checked="" type="checkbox"/> A <input type="checkbox"/> B	PASS	
Y	1	<input checked="" type="checkbox"/> A <input type="checkbox"/> B	PASS	
Z	1	<input checked="" type="checkbox"/> A <input type="checkbox"/> B	PASS	

For Strict Test:

Xindian Lab.

Temperature	19°C	Humidity	55% RH
Pressure	1007	Tested By	PIPO
Required Passing Performance		Criterion A	

DIRECTION	Field Strength (A/m)	Performance Criterion	Result	Observation
X	100	<input checked="" type="checkbox"/> A <input type="checkbox"/> B	PASS	
Y	100	<input checked="" type="checkbox"/> A <input type="checkbox"/> B	PASS	
Z	100	<input checked="" type="checkbox"/> A <input type="checkbox"/> B	PASS	

8.9. VOLTAGE DIPS & VOLTAGE INTERRUPTIONS

8.9.1. TEST SPECIFICATION

Basic Standard:	IEC 61000-4-11
Test duration time:	Minimum three test events in sequence
Interval between event:	Minimum 10 seconds
Phase Angle:	0° / 45° / 90° / 135° / 180° / 225° / 270° / 315° / 360°
Test cycle:	3 times

8.9.2. TEST INSTRUMENT

Immunity shielded room				
Name of Equipment	Manufacturer	Model	Serial Number	Calibration Due
EMS Test System	KeyTek	EMCpro	0312231	11/19/2016
Software	CE Ware 3.00b			

Note:

1. The calibration interval of the above test instruments is 12 months and the calibrations are traceable to NML/ROC and NIST/USA.
2. N.C.R.= No Calibration Required.

8.9.3. TEST PROCEDURE

- a) The EUT and support units were located on a wooden table, 0.8 m away from ground floor.
- b) Setting the parameter of tests and then perform the test software of test simulator.
- c) Conditions changes to occur at 0 degree crossover point of the voltage waveform.
- d) Recording the test result in test record form.

8.9.4. TEST SETUP

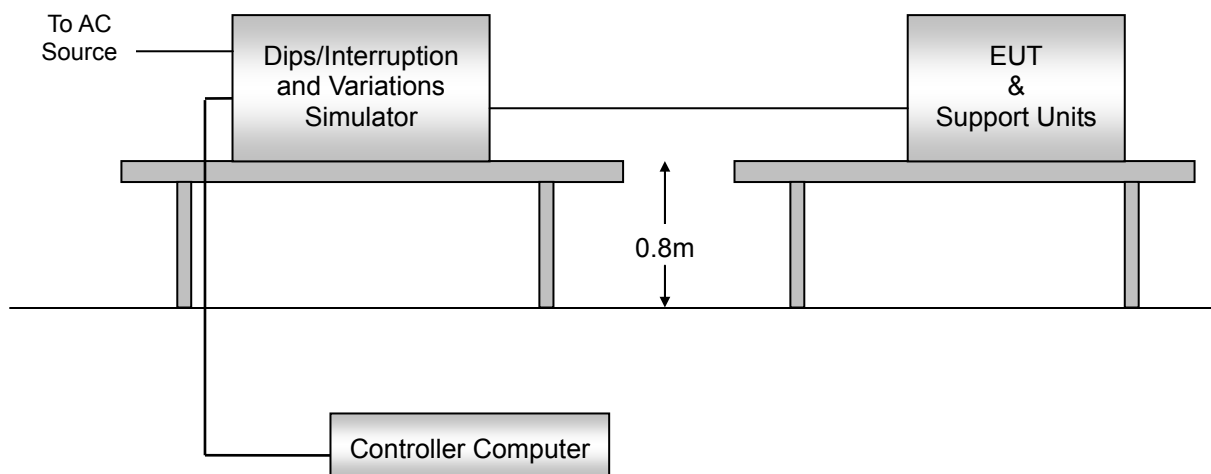

For the actual test configuration, please refer to the related item - Photographs of the Test Configuration.

8.9.5. TEST RESULTS

✘ This EUT is not connected to AC Source directly. Not applicable for this test.

Temperature	--- °C	Humidity	--- % RH
Pressure	--- mbar	Tested by	---
Required Passing Performance	Criterion B: >95% reduction 0.5 periods Criterion C: 30% reduction 25 periods & >95% reduction 250 periods		

Test Power: 230Vac, 50Hz				
Voltage (% Reduction)	Duration (Period)	Performance Criterion	Result	Observation
>95	---	<input type="checkbox"/> A <input type="checkbox"/> B <input type="checkbox"/> C	---	
30	---	<input type="checkbox"/> A <input type="checkbox"/> B <input type="checkbox"/> C	---	
>95	---	<input type="checkbox"/> A <input type="checkbox"/> B <input type="checkbox"/> C	---	

9 PHOTOGRAPHS OF THE TEST CONFIGURATION CONDUCTED EMISSION TEST (Model: ERM00CC18-HS)



Model: ERM02A18-HS



Model: ERM00CC110-HS



Model: ERM02A110-HS



Model: ERM01CC18-HS



Model: ERM04A18-HS



Model: ERM01CC110-HS



Model: ERM04A110-HS



RADIATED EMISSION TEST (Model: ERM00CC18-HS)



Model: ERM02A18-HS



Model: ERM00CC110-HS



Model: ERM02A110-HS



Model: ERM01CC18-HS



Model: ERM04A18-HS



Model: ERM01CC110-HS



Model: ERM04A110-HS



ESD TEST (Model: ERM02A18-HS)

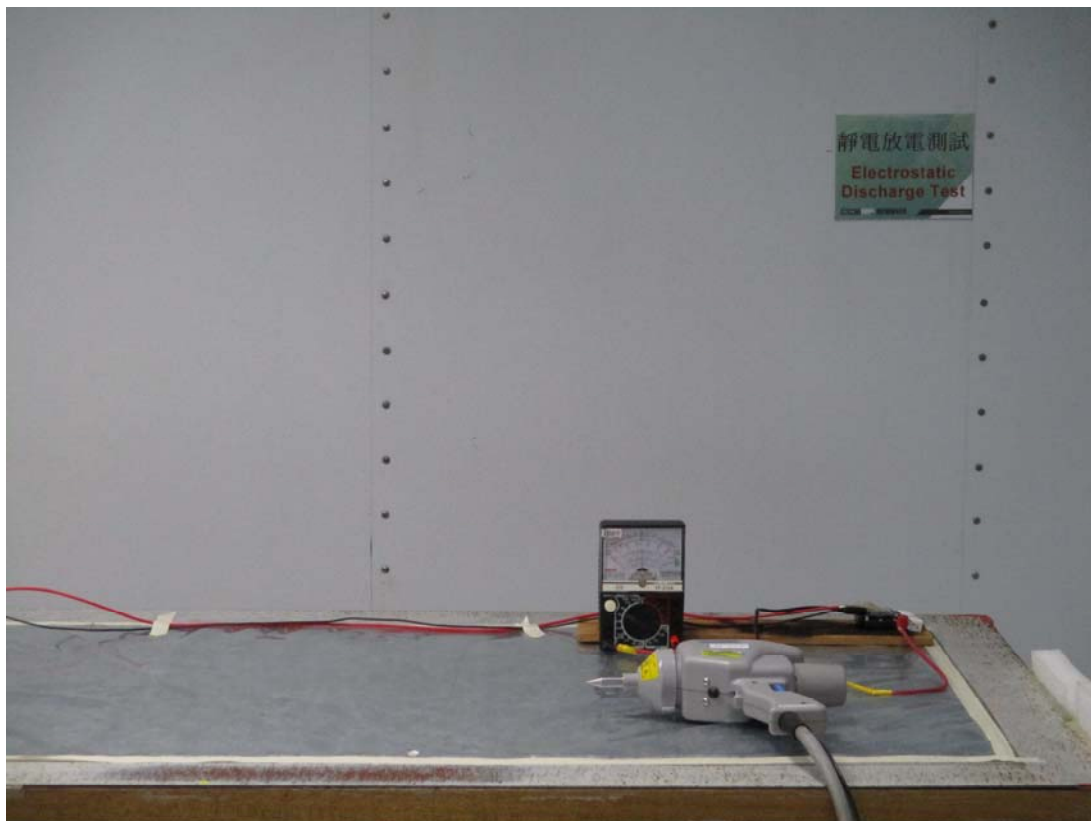

RS TEST (Model: ERM02A18-HS)



EFT TEST (Model: ERM02A18-HS)

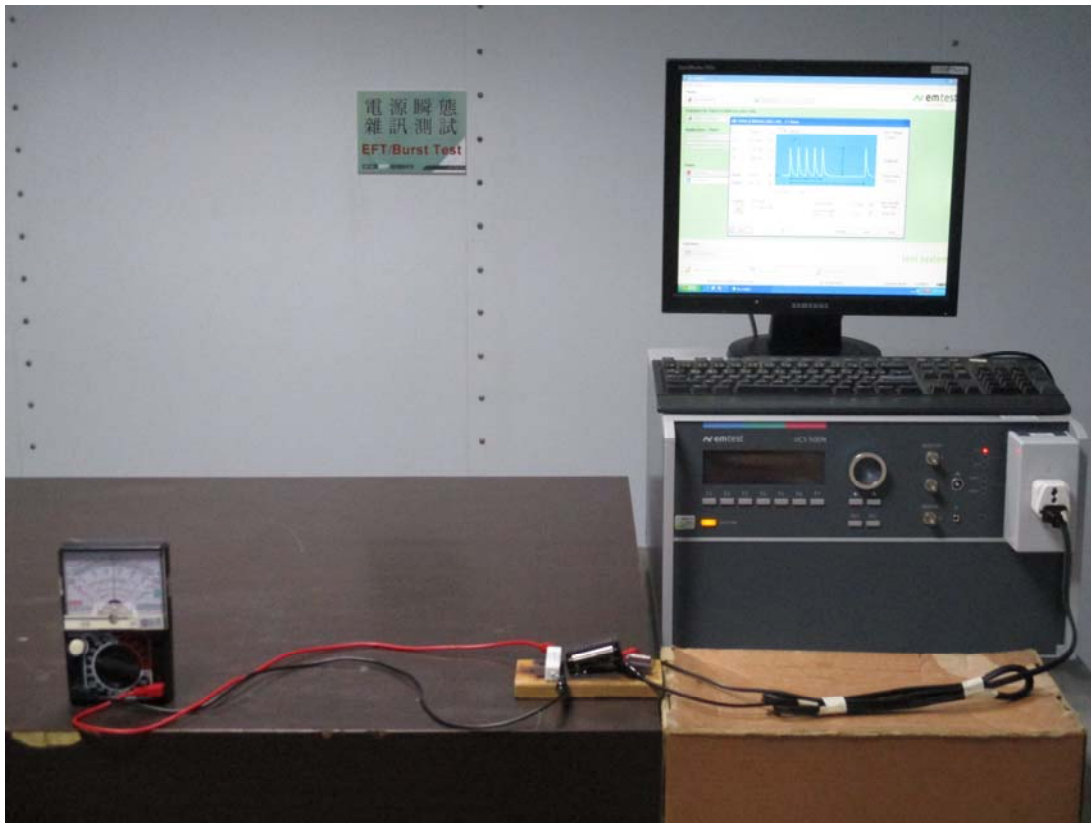

SURGE TEST (Model: ERM02A18-HS)



CS TEST (Model: ERM02A18-HS)

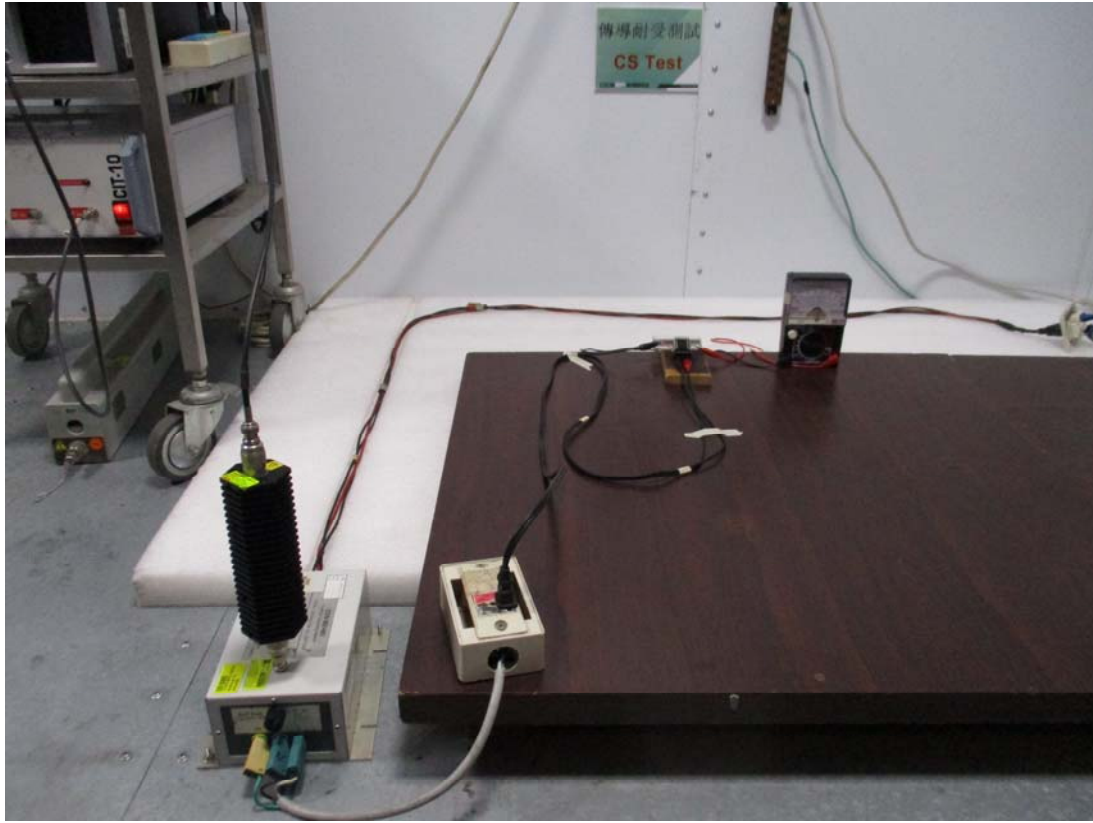

PFMF TEST (Model: ERM02A18-HS)

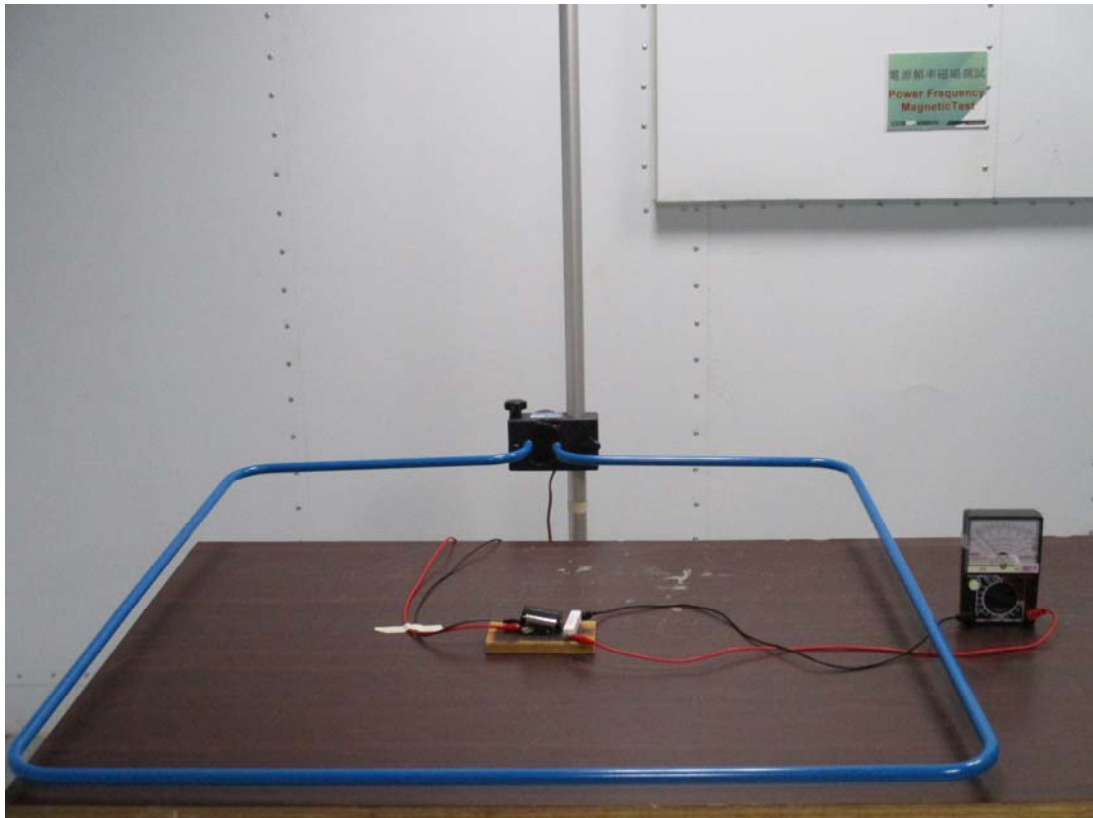

PFMF TEST (Model: ERM02A18-HS) for Xindian Lab.

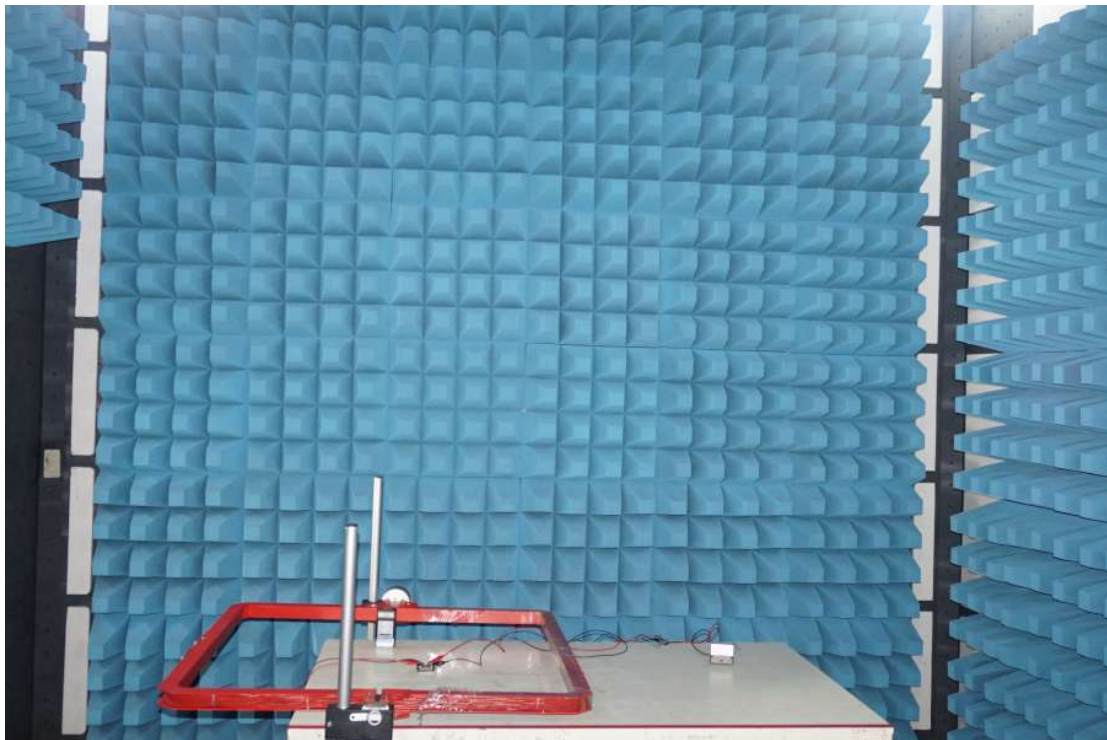

ESD TEST (Model: ERM04A18-HS)

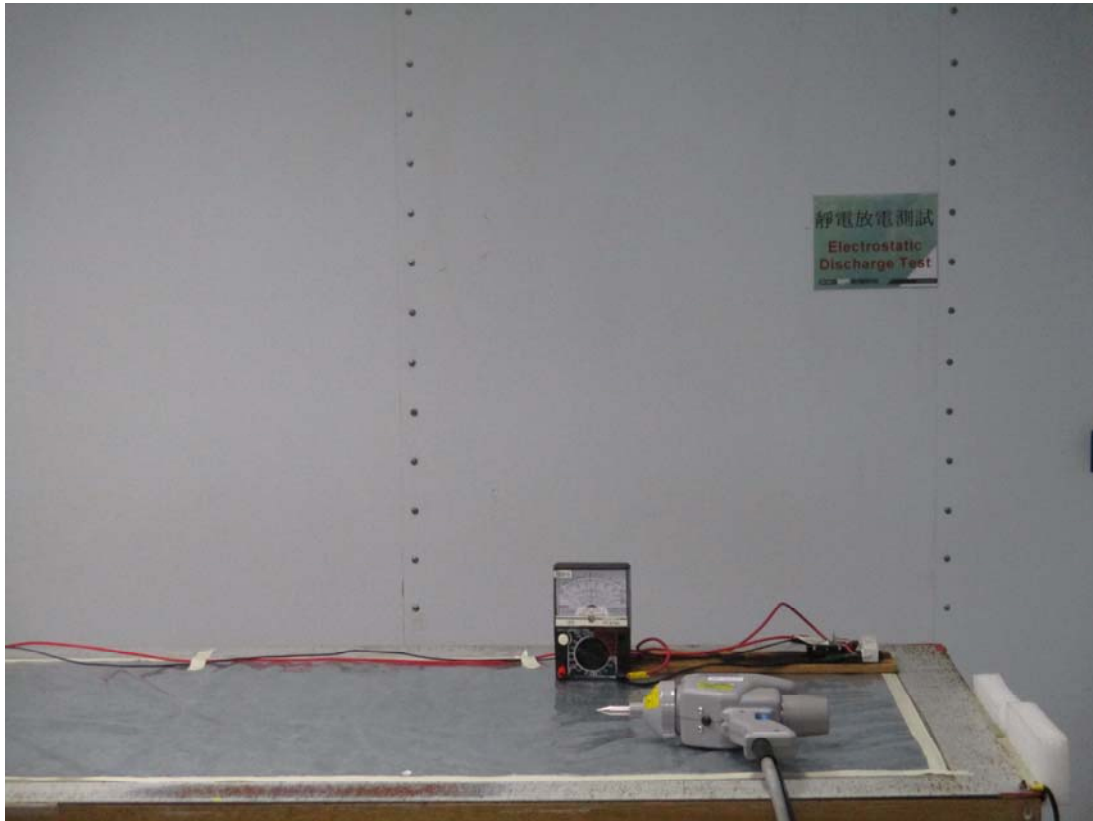

RS TEST (Model: ERM04A18-HS)

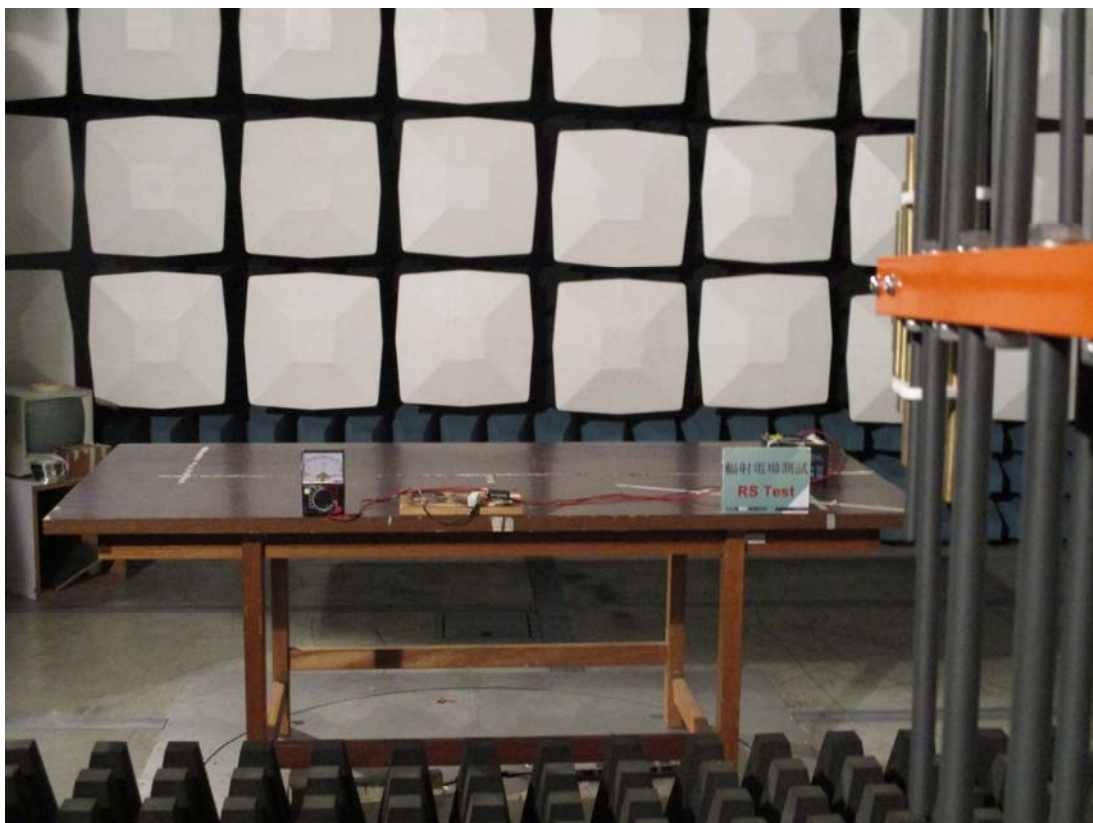

EFT TEST (Model: ERM04A18-HS)



SURGE TEST (Model: ERM04A18-HS)



CS TEST (Model: ERM04A18-HS)

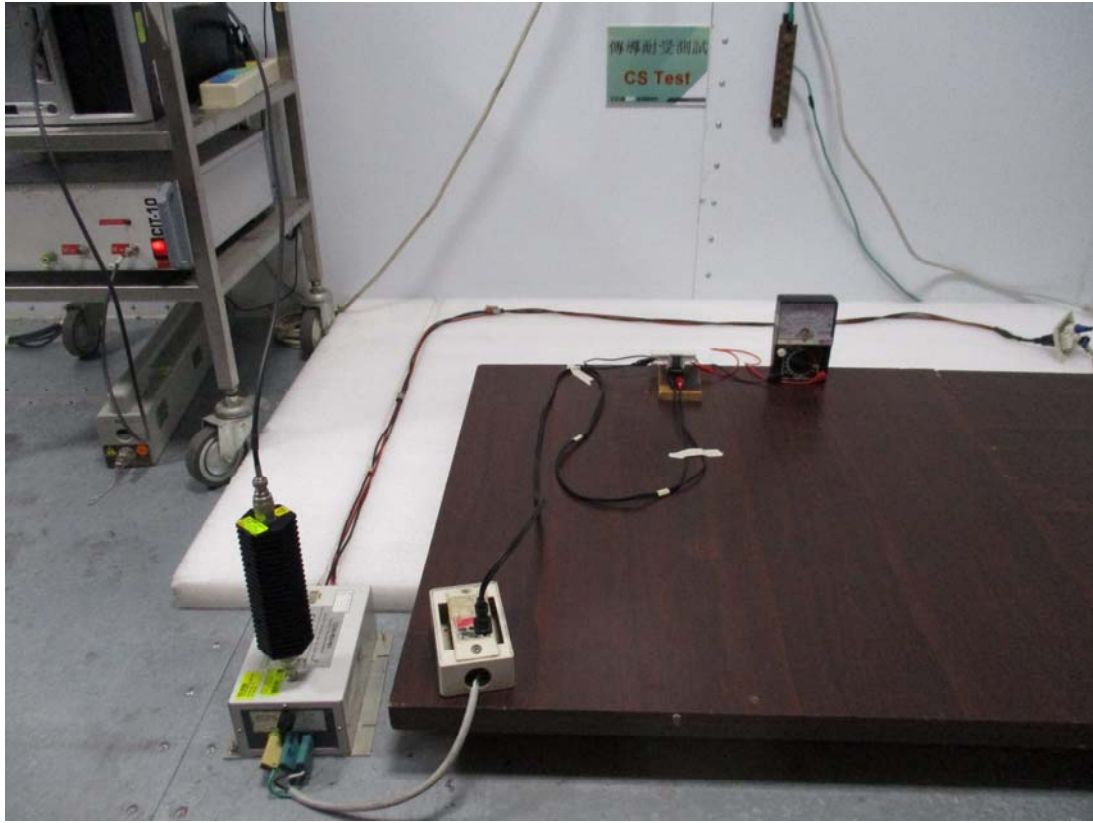

PFMF TEST (Model: ERM04A18-HS)

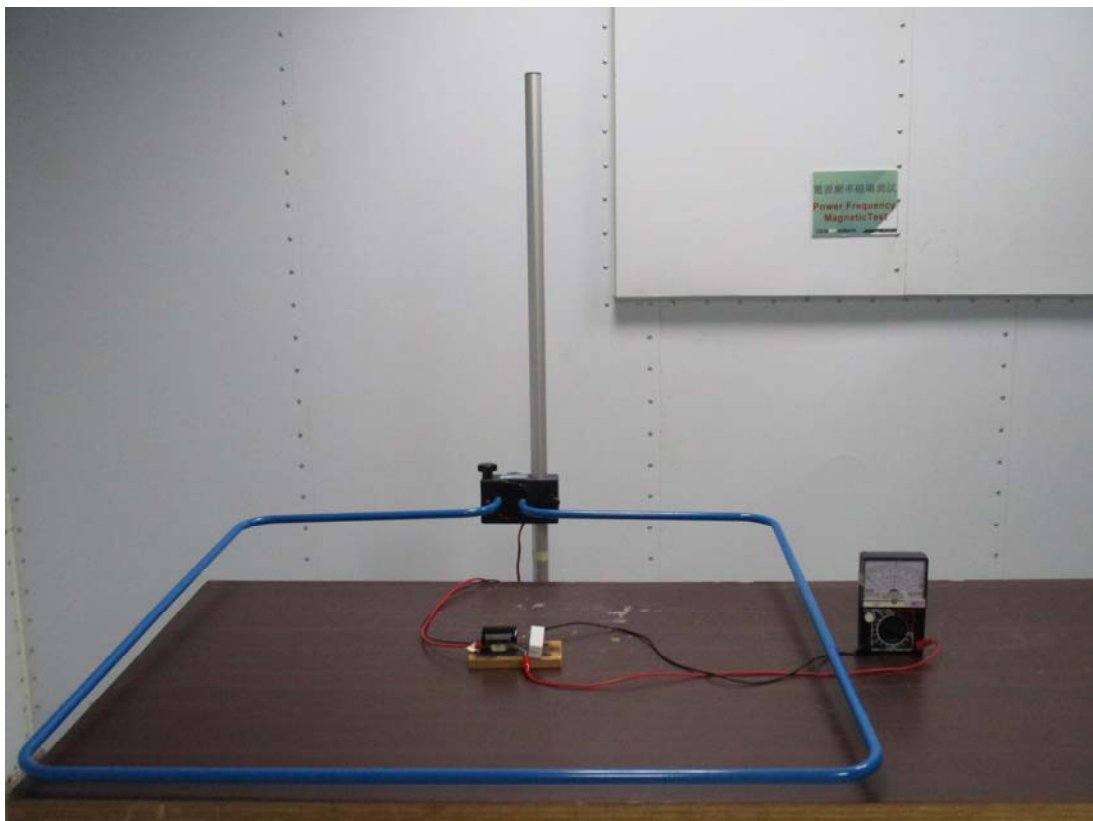

PFMF TEST (Model: ERM04A18-HS-HS) for Xindian Lab.

