



**CONTROLLED**

09/02/2005

**APPROVED VENDOR SPECIFICATION**



Vendor Name : LANDWIN

Catalog Name : N/A

Catalog Date / Revision : N/A

---

REMARK : P/N 138-00015240 WAS INCLUDED IN DWG# 13800014080-19.

CHANGE : ADD P/N 138-66002790 AND 138-00015240.  
ADD SPECS SHEET, PAGE 5.

ISSUE : 03

---

ECO # :

---

PREPARED BY : Marife Sumalbag

CHECK :

APPROVED :

DATE : 8/25/2005

DATE : 30AUG05

DATE : 30AUG05

---

## APPROVED VENDOR SPECIFICATION



Part Number	Description	Vendor Part Number	First Used On
138-00014450	HSG 2WAY 2510	2510S-02	GENERAL
138-00015240	HSG 3WAY 2510	2510S-03	GENERAL
138-00015690	HSG 4WAY 2510	2510S-04	GENERAL
138-00015700	HSG 6WAY 2510	2510S-06	GENERAL
138-00018010	HSG 3WAY 2510S LW	2510S-0300	GENERAL
138-00020030	HSG-PLUG 4WAY W-W 2510M-04	2510M-04	SA147-3505-011
138-00020220	HSG-PLUG 4WAY W-W 2510M04N	2510M04N	SA147-3505-011
138-00022300	HDR B-RT 2.0 6WAY 175489-6 AP	2510S-0800	AA20320
138-66002790	HSG-2WAY 2510S02N0 LW	2510S02N0	73-540-0001
403-02209190	TERM MALE 2513MT1	2513MT1	SA147-3505-011

# 2510MXX HOUSING

- \* MATERIAL : NYLON 66 94V-0 (NATURAL)
- \* CIRCUITS : 2P~15P
- \* ACCEPT TERMINAL : 2513MTX
- \* CURRENT & VOLTAGE RATING : 2A, 250V AC, DC
- \* INSULATION RESISTANCE : 1000MΩ MIN
- \* CONTACT RESISTANCE : 20mΩ MAX

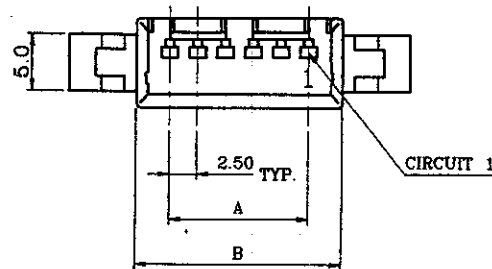

## DWG. NO./DIMENSIONS

CIRCUITS	DWG. NO.		DIM. A	DIM. B	DIM. C
	WITH EARS	W/O EARS			
2	2510M02	2510M02N	2.50	8.60	5.80
3	2510M03	2510M03N	5.00	11.10	8.30
4	2510M04	2510M04N	7.50	13.60	10.80
5	2510M05	2510M05N	10.00	16.10	13.30
6	2510M06	2510M06N	12.50	18.60	15.80
7	2510M07	2510M07N	15.00	21.10	18.30
8	2510M08	2510M08N	17.50	23.60	20.80
9	2510M09	2510M09N	20.00	26.10	23.30
10	2510M10	2510M10N	22.50	28.60	25.80
11	2510M11	2510M11N	25.00	31.10	28.30
12	2510M12	2510M12N	27.50	33.60	30.80
13	2510M13	2510M13N	30.00	36.10	33.30
14	2510M14	2510M14N	32.50	38.60	35.80
15	2510M15	2510M15N	35.00	41.10	38.30

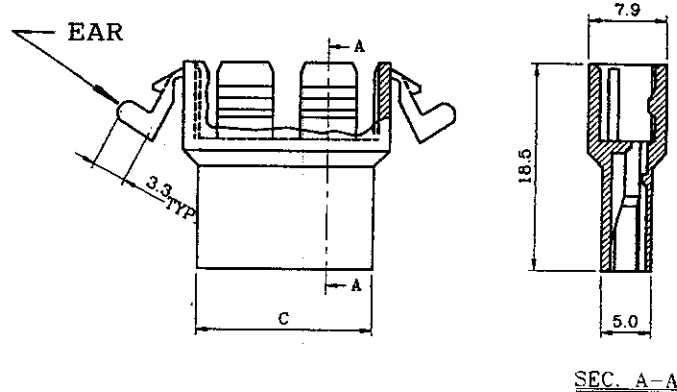

# 2513MTX TERMINAL

- \* MATERIAL : PHOSPHOR BRONZE / BRASS  
TIN-PLATED
- \* ACCEPT HOUSING : 2510MXX
- \* APPLICABLE WIRE : AWG22 ~ 28

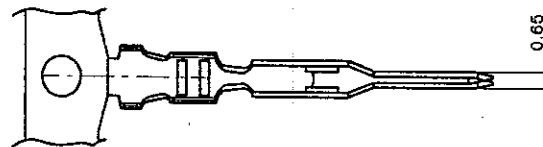

## DWG. NO./DIMENSIONS

DWG. NUMBER	TERMINAL TYPE	WIRE GAUGE	CONTACT MATERIAL
2513MT1	CHAIN	#22-#28	BRASS
2513MT2			PHOSPHOR BRONZE

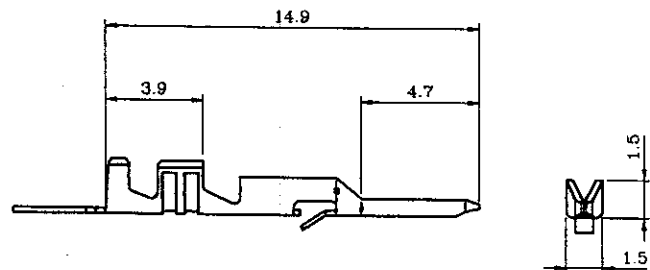

ASTEC APPROVED VENDOR SPEC	CHK <i>Chiyu</i> DATE 23 OCT 97
DESC. HSG-PLUG	
DWG NO. 138-00020030	SHEET A1

P.5  
 MKR 19 '99 12:01PM LANDWIN CORP 7904110

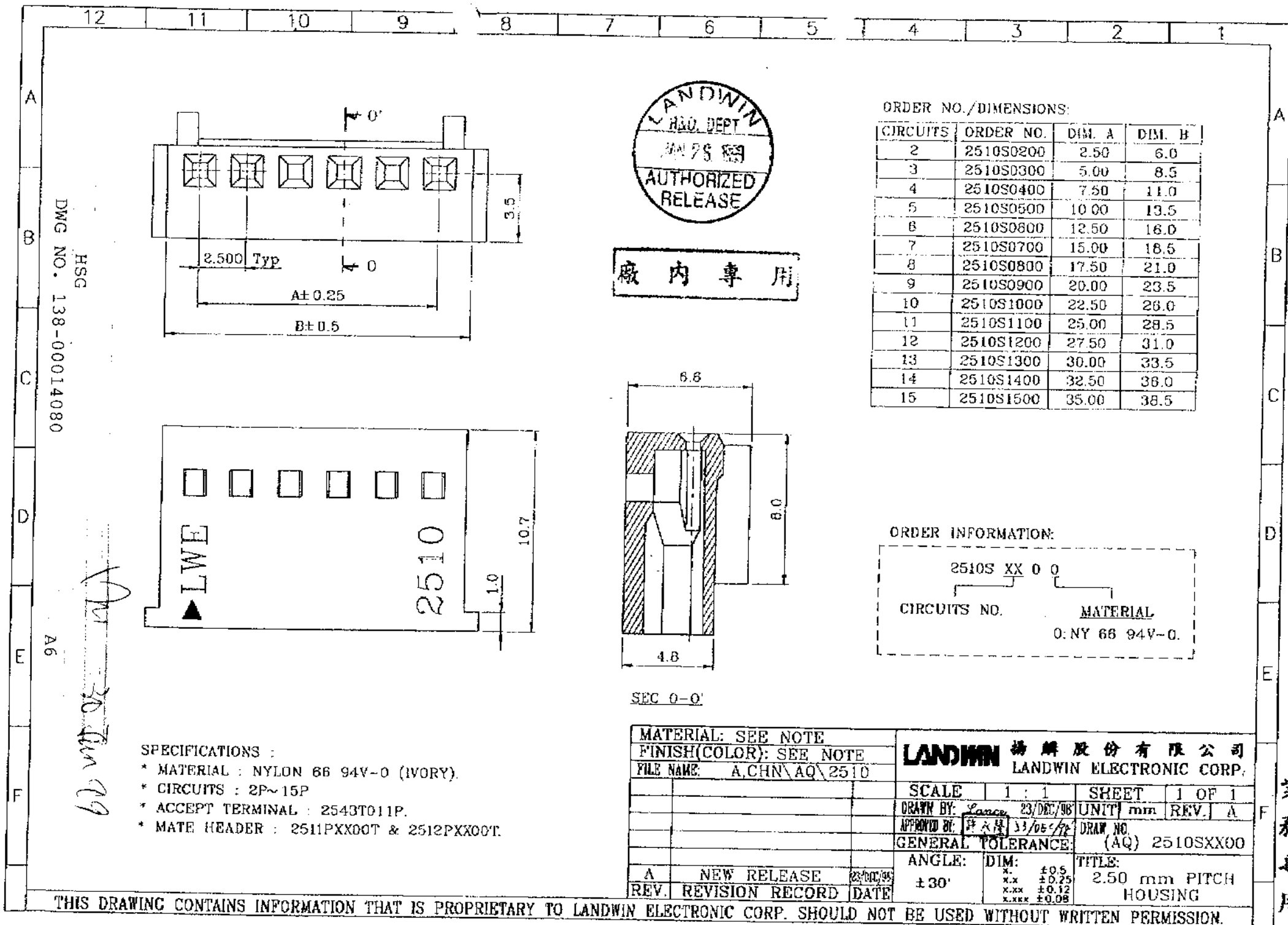

DWG NO. 138-00014080  
 HSG

A6

*Handwritten note:* 2510 29

- SPECIFICATIONS :**
- \* MATERIAL : NYLON 66 94V-0 (IVORY).
  - \* CIRCUITS : 2P~15P
  - \* ACCEPT TERMINAL : 2543T011P.
  - \* MATE HEADER : 2511PXX00T & 2512PXX00T.



廠內專用

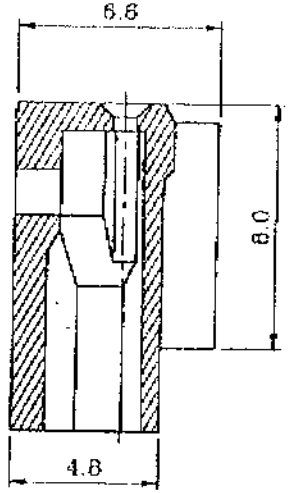

SEC 0-0

ORDER NO./DIMENSIONS:

CIRCUITS	ORDER NO.	DIM. A	DIM. B
2	2510S0200	2.50	6.0
3	2510S0300	5.00	8.5
4	2510S0400	7.50	11.0
5	2510S0500	10.00	13.5
6	2510S0800	12.50	16.0
7	2510S0700	15.00	18.5
8	2510S0800	17.50	21.0
9	2510S0900	20.00	23.5
10	2510S1000	22.50	26.0
11	2510S1100	25.00	28.5
12	2510S1200	27.50	31.0
13	2510S1300	30.00	33.5
14	2510S1400	32.50	36.0
15	2510S1500	35.00	38.5

ORDER INFORMATION:

2510S XX 0 0  
 CIRCUITS NO. MATERIAL  
 0: NY 66 94V-0.

MATERIAL: SEE NOTE		SCALE: 1 : 1		SHEET: 1 OF 1	
FINISH(COLOR): SEE NOTE		DRAWN BY: <i>Lance</i> 23/DEC/98		UNIT: mm REV: A	
FILE NAME: A.CHN\AQ\2510		APPROVED BY: <i>許文雄</i> 33/05/99		DRAW NO.	
		GENERAL TOLERANCE:		(AQ) 2510SXX00	
A	NEW RELEASE	ANGLE: $\pm 30^\circ$	DIM: $\pm 0.5$	TITLE: 2.50 mm PITCH HOUSING	
REV.	REVISION RECORD	DATE	$\pm 0.25$		
			$\pm 0.12$		
			$\pm 0.08$		

THIS DRAWING CONTAINS INFORMATION THAT IS PROPRIETARY TO LANDWIN ELECTRONIC CORP. SHOULD NOT BE USED WITHOUT WRITTEN PERMISSION.

業務專用

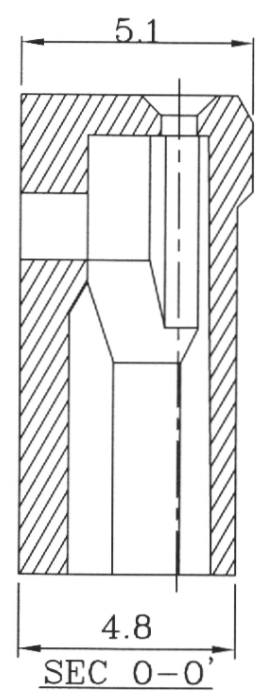
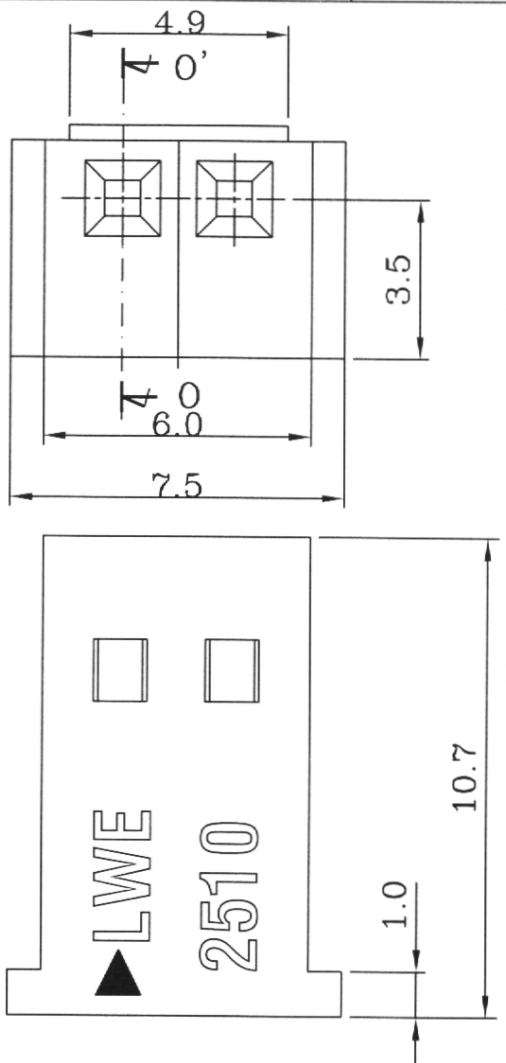

圖面僅供參考  
 94年7月20日  
 聯盈公司 研發部

ORDER INFORMATION:  
 2510S 02 N 0  
 CIRCUITS NO. MATERIAL  
 0: NY 66 94V-0.

- SPECIFICATIONS :
- \* MATERIAL : NYLON 66 94V-0 (IVORY).
  - \* CIRCUITS : 2P
  - \* ACCEPT TERMINAL : 2543T011P.
  - \* MATE HEADER : 2511PXX00T & 2512PXX00T.

MATERIAL: NYLON 66 94V-0		<b>LANDWIN</b> 聯盈電子股份有限公司 LANDWIN ELECTRONIC CORP.					
FINISH(COLOR): IVORY COLOR							
FILE NAME:		SCALE	1 : 1	SHEET	1 OF 1		
		DRAWN BY: Peter	01/APR/03	UNIT	mm	REV.	A
		APPROVED BY:		DRAW NO.			
		GENERAL TOLERANCE:		TITLE: (AQ) 2510S02N0			
		ANGLE:	DIM:	TITLE:			
A NEW RELEASE		±3°	x. ±0.5	2.5mm PITCH			
REV. REVISION RECORD			x.x ±0.25	HOUSING			
ECN NO.			x.xx ±0.12				
DATE			x.xxx ±0.06				