

ARTESYN LCM600 SERIES

600 Watts Bulk Front End



PRODUCT DESCRIPTION

Advanced Energy's Artesyn LCM600 series provide for a very wide range of AC-DC embedded power requirement. Featuring high build quality with robust screw terminals, long life, and 89 percent typical efficiency, these units are ideal for use in industrial and medical applications. They are backed by a comprehensive set of industrial and medical safety approvals and certificates. Variable-speed 'Smart Fans' draw on software controls developed by Advanced Energy to match fan speed to the unit's cooling requirement and load current. Slowing the fan not only saves power but also reduces wear, thus extending its life.

SPECIAL FEATURES

- 600W output power
- Low cost
- 2.4"X4.5"X7.5"
- 7.41W/in³
- Optional 5V @ 2A housekeeping
- Industrial/medical safety
- -40°C to +70°C with derating
- High efficiency 89% typical
- Variable speed "Smart Fans"
- DSP controlled front end
- Conformal coat option
- ±20% adjustment range
- Margin programming
- OR-ing FET
- Terminal block input option

SAFETY

- UL/CSA: UL/CSA62368-1
- UL/CSA: ES60601-1
CSA C22.2
No.60601-1
- TUV: EN62368-1
- TUV: EN60601-1
- UKCA Mark
- CCC: GB4943
GB9254
GB17625
- CB Report: IEC60950-1
IEC60601-1

AT A GLANCE

Total Power

600 Watts

Input Voltage

85 to 264 Vac

of Outputs

Main + Standby



MODEL NUMBERS

Standard ¹	Output Voltage	Minimum Load	Maximum Load ²	Adjustment Range	Maximum Power ³
LCM600L	12Vdc	0A	52A	9.6 - 14.4Vdc	600W
LCM600N	15Vdc	0A	44A	12.0 - 19.5Vdc	600W
LCM600Q	24Vdc	0A	27A	19.2 - 28.8Vdc	600W
LCM600U	36Vdc	0A	16.7A	28.8 - 43.2Vdc	600W
LCM600W	48Vdc	0A	13A	38.4 - 57.6Vdc	600W

Note 1 - Add "-T" for terminal block instead of IEC input.
 Add "-4" for 5V standby.
 Add "-8" for constant current mode.
 Add "-A" for new aesthetics.
 Add "-N" for low noise model on 12 V or 24 V models.

Note 2 - Maximum load current can be extended but output voltage needs to be adjusted to minimum value to meet 600W output power. If output voltage is further trimmed down to -20% of the nominal, the same max output load applies. On the other hand, increasing the output voltage to +20% of the nominal should decrease output load accordingly to meet 600W output power.

Note 3 - The maximum continuous average output power from this power supply will be 600W or 610W if the optional standby is available.

ELECTRICAL SPECIFICATIONS

Absolute Maximum Ratings

Stress in excess of those listed in the “Absolute Maximum Ratings” may cause permanent damage to the power supply. These are stress ratings only and functional operation of the unit is not implied at these or any other conditions above those given in the operational sections of this TRN. Exposure to any absolute maximum rated condition for extended periods may adversely affect the power supply’s reliability.

Table 1. Absolute Maximum Ratings						
Parameter	Model	Symbol	Min	Typ	Max	Unit
Input Voltage AC continuous operation	All models	$V_{IN,AC}$	85	-	264	Vac
Maximum Output Power, continuous	All models	$P_{O,max}$	-	-	600	W
Isolation Voltage (Qualification)						
Input to outputs(2xMOPP)	All models		-	-	4000	Vac
Input to safety ground(1XMOPP)	All models		-	-	2500	Vac
Outputs to safety ground(1XMOPP)	All models		-	-	500	Vdc
Isolation Voltage (Production)						
Input to outputs(2xMOPP)	All models		-	-	1800	Vac
Input to safety ground(1xMOPP)	All models		-	-	1800	Vdc
Outputs to safety ground(1xMOPP)	All models		-	-	200	Vdc
Ambient Operating Temperature	All models	T_A	-40	-	+70 ¹	°C
Storage Temperature	All models	T_{STG}	-40	-	+85	°C
Humidity (non-condensing)						
Operating	All models		20	-	90	%
Non-operating	All models		10	-	95	%
Altitude						
Operating	All models		-	-	16404.2	feet
Non-operating	All models		-	-	30000	feet

Note 1 - Line derating each output at 2.5% per degree C from 50°C to 70°C (see page 33 power derating curve)

ELECTRICAL SPECIFICATIONS

Input Specifications

Table 2. Input Specifications						
Parameter	Condition	Symbol	Min	Typ	Max	Unit
Operating Input Voltage, AC	All	$V_{IN,AC}$	85	115/230	264	Vac
Input AC Frequency	All	f_{IN}	47	50/60	440	Hz
Maximum Steady State Input Current	$V_{IN,AC} = 100Vac$	$I_{IN,max}$	-	-	8	A
Standby Input Current ($V_O = Off, I_{SB} = 0A$)	All				250	mA
No Load Input Current ($V_O = On, I_O = 0A, I_{SB} = 0A$)	All	$I_{IN,no-load}$	-	-	350	mA
Harmonic Line Currents	All	THD	Per EN61000-3-2			
Power Factor	$I_O = I_{O,max}$ $V_{IN,AC} = 85 \text{ to } 264Vac$	PF	-	0.99	-	-
Startup Surge Current (Inrush) @ 25°C	$V_{IN,AC} = 264Vac$	$I_{IN,surge}$	-	-	25	A_{PK}
Input Fuse	Internal, L and N 250Vac rated		-	-	10	A
Input AC Low Line Start-up Voltage	$I_O = I_{O,max}$	$V_{IN,AC-start}$	70	-	80	Vac
Input AC Undervoltage Lockout Voltage	$I_O = I_{O,max}$	$V_{IN,AC-stop}$	50	-	65	Vac
Standby Input Power ($V_O = Off, I_{SB} = 0A$)	All		-	-	15	W
No Load Input Power ($I_O = 0$)	All	$P_{IN,no-load}$	-	-	30	W
PFC Switching Frequency	All	$f_{SW,PFC}$	60	-	70	KHz
Ripple Switching Frequency	LCM600N LCM600Q LCM600U LCM600W	$f_{SW,DC-DC}$	140	-	150	KHz
	LCM600L	$f_{SW,DC-DC}$	150	-	160	KHz
Efficiency ($T_A = 25^\circ C$, forced air cooling and include the o-ring losses)	$V_{IN,AC} = 230Vac$ $I_O = I_{O,max}$	η	-	89	-	%
Hold Up Time	$V_{IN,AC} = 100Vac$ $P_O = P_{O,max}$ $T_A = 25^\circ C$	$t_{Hold-Up}$	20	-	-	mSec
Turn On Delay Resistive Load	$V_{IN,AC} = 85Vac$ $I_O = I_{O,max}$	$t_{Turn-On}$	-	-	3	Sec
Leakage Current to safety ground	UL test method	$I_{IN,leakage}$	-	-	0.3	mA
	IEC test method	$I_{IN,leakage}$	-	-	0.5	mA

ELECTRICAL SPECIFICATIONS

Output Specifications

Table 3. Output Specifications							
Parameter		Condition	Symbol	Min	Typ	Max	Unit
Factory Set Voltage	LCM600L	$I_o = 0A$	$V_{O, factory}$	11.94	12.0	12.06	Vdc
	LCM600N			14.925	15.0	15.075	
	LCM600Q			23.88	24.0	24.12	
	LCM600U			35.82	36.0	36.18	
	LCM600W			47.76	48.0	48.24	
Output Adjust Range	LCM600L	$I_o = 0A$ See note 1	V_o	9.6	-	14.4	Vdc
	LCM600N			12	-	19.5	
	LCM600Q			19.2	-	28.8	
	LCM600U			28.8	-	43.2	
	LCM600W			38.4	-	57.6	
Standby Output Adjust Range			V_{SB}	4.8	5	5.4	Vdc
Total Regulation		Inclusive of line, load temperature change, warm-up drift	V_o	-2.0	-	+2.0	% V_o
Output Ripple, pk-pk	LCM600L	See note 2	V_o	-	-	120	mV
	LCM600N			-	-	150	
	LCM600Q			-	-	240	
	LCM600U			-	-	360	
	LCM600W			-	-	480	
Standby Output Ripple, pk-pk			V_{SB}	-	-	100	mV
Output Current, continuous	LCM600L	See note 3 and 4	$I_{O,max}$	0	-	54	A
	LCM600N					44	
	LCM600Q					27	
	LCM600U					16.7	
	LCM600W					14	
Maximum Output Power, continuous			$P_{O,max}$	-	-	600	W
Standby Output Current			I_{SB}	0	-	2	A

ELECTRICAL SPECIFICATIONS

Output Specifications

Table 3. Output Specifications						
Parameter	Condition	Symbol	Min	Typ	Max	Unit
Dynamic Response - Peak Deviation	50% to 100% of $I_{O,max}$ Slew rate = 1A/ μ s See note 5	$\pm\%V_O$	-	-	2	%
Turn On Overshoot	$I_O = 0$	$\%V_O$	-	-	10	%
Overload Protection	Bouncing mode	I_O	105		125	$\%I_{O,max}$
Standby Overload Protection		I_{SB}	120	-	170	$\%I_{SB,max}$
Over Voltage Protection		V_O	125	-	145	$\%V_O$
Standby Output Voltage Protection		V_{SB}	110	-	125	$\%V_{SB}$
Load Capacitance	Startup		0	-	4700	μ F
Standby Max Capacitive Load			0	-	270	μ F
Over Temperature Protection	Auto Recovery		10°C to 15°C above safe operating area			

Note 1 - See page 20 for voltage adjustment pot location.

Note 2 - Measure with a 0.1mF ceramic capacitor in parallel with a 10mF tantalum capacitor using a 20MHz bandwidth limited oscilloscope.

Note 3 - Standard operating orientation is front side facing forward.

Note 4 - Operation up to 50% load permissible with sideways (horizontal) or front side up (top) mounting orientation.

Note 5 - Tested with minimum output capacitor of 470 μ F on main output and 270 μ F on 5V standby. For LCM600L/N series, main output is tested with 4700 μ F output capacitor with a minimum loading of 10% with respect to its maximum load.

ELECTRICAL SPECIFICATIONS

System Timing Specifications

Table 4. Timing Specifications					
Label	Parameter	Min	Typ	Max	Unit
T1	Delay from AC being applied to main output voltages being within regulation.	-	-	3000	mSec
T2	Delay from AC being applied to ACOK signal assertion (going low).	200	-	1500	mSec
T3	Delay from main output within regulation to DCOK signal assertion (going low).	-	-	500	mSec
T4	Hold up time - Delay from AC loss to main output within regulation. Main output set at nominal voltage setting.	20	-	-	mSec
T5	Delay from AC loss to ACOK signal de-assertion (going high).	5	-	12	mSec
T6	Delay from DCOK signal de-assertion (going high) to main output dropping to less than the lower trimming range (-20% of the nominal output).	1	-	-	mSec
T7	Delay from INH_EN going high to main output being within regulation (90% Vo of the nominal voltage).	-	-	2000	mSec
T8	Delay from INH_EN going high to DCOK signal going high.	-	-	2	mSec

ELECTRICAL SPECIFICATIONS

System Timing Diagram

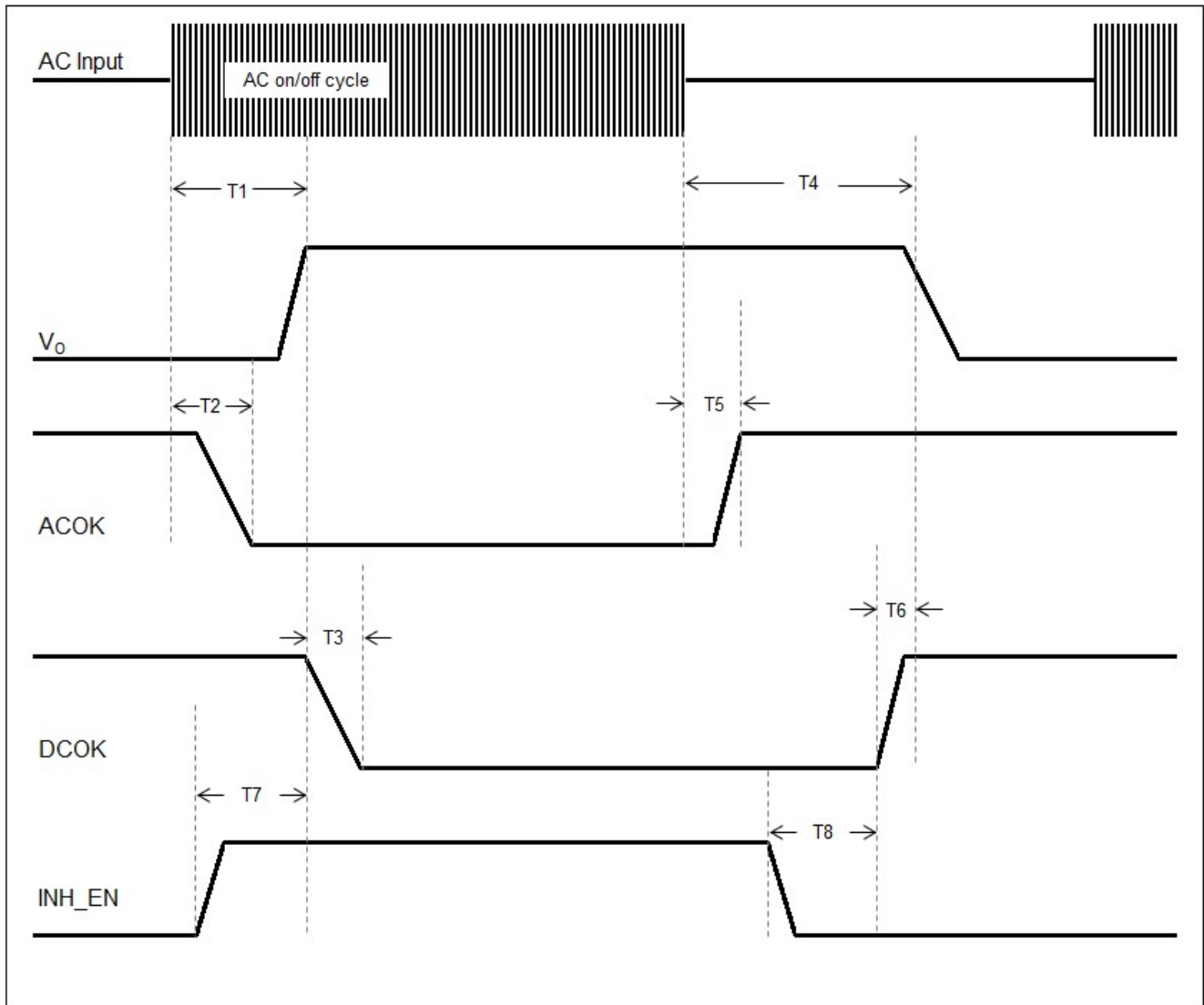

ELECTRICAL SPECIFICATIONS

LCM600L Performance Curves

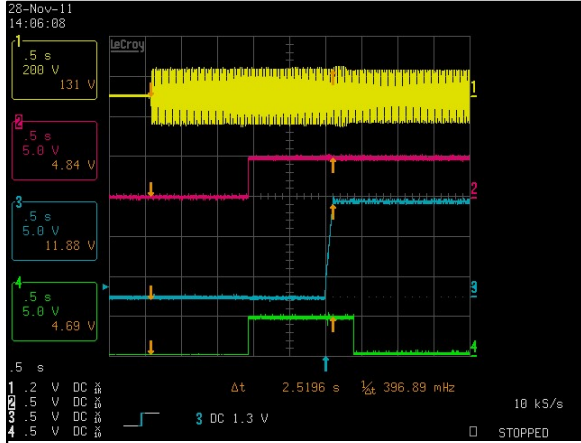

Figure 1: LCM600L Turn-on Delay via AC Mains - Vin = 90Vac
 Load: Io = 50A (12V), I_{SB} = 2A (5V)
 Ch 1: AC Mains Ch 2: V_{SB} Ch 3: Vo Ch 4: POWER GOOD

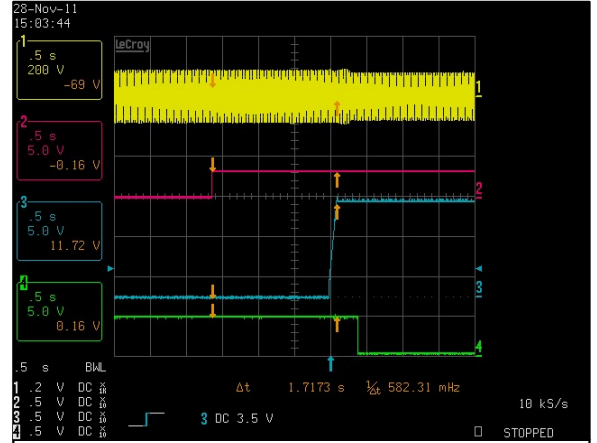

Figure 2: LCM600L Turn-on Delay via INH_EN - Vin = 90Vac
 Load: Io = 50A (12V), I_{SB} = 2A (5V)
 Ch 1: AC Mains Ch 2: V_{SB} Ch 3: Vo Ch 4: POWER GOOD

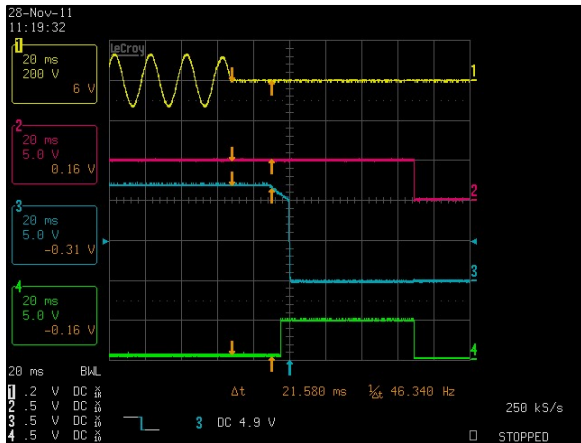

Figure 3: LCM600L Hold-up Time - Vin = 90Vac / 63Hz / 0°
 Load: Io = 50A (12V), I_{SB} = 2A (5V)
 Ch 1: AC Mains Ch 2: V_{SB} Ch 3: Vo Ch 4: POWER GOOD

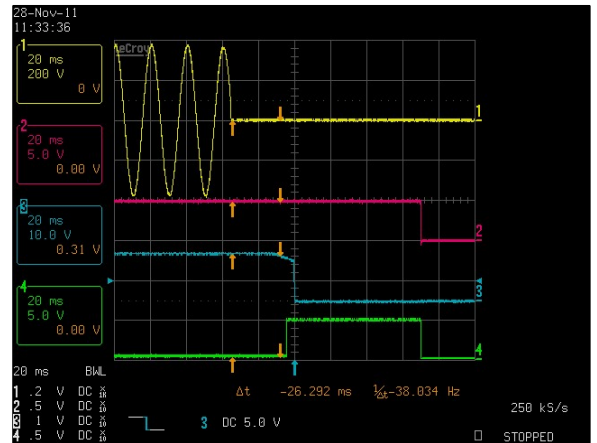

Figure 4: LCM600L Hold-up Time - Vin = 264Vac / 47Hz / 0°
 Load: Io = 50A (12V), I_{SB} = 2A (5V)
 Ch 1: AC Mains Ch 2: V_{SB} Ch 3: Vo Ch 4: POWER GOOD

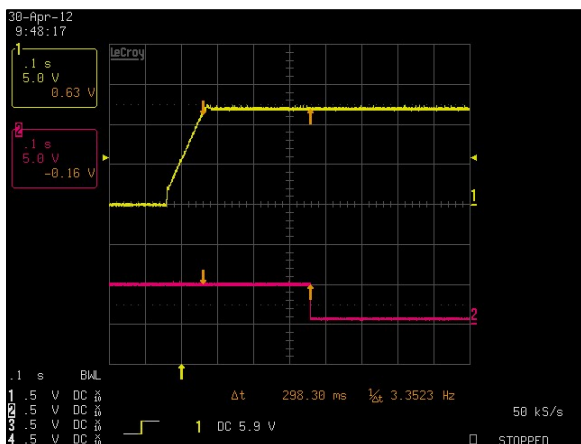

Figure 5: LCM600L Output Voltage Startup Characteristic
 Vin = 90Vac Full Load: Io = 50A (12V), I_{SB} = 2A (5V)
 Ch 1: Vo Ch 2: POWER GOOD

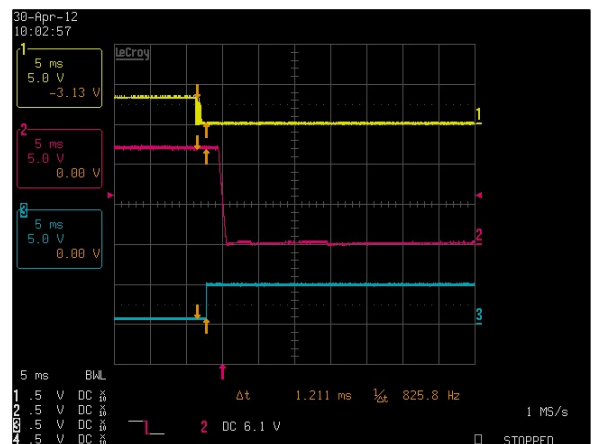

Figure 6: LCM600L Turn-off Characteristic via INH_EN
 Full Load: Io = 50A (12V), I_{SB} = 2A (5V)
 Ch 1: INH_EN Ch 2: Vo Ch 3: POWER GOOD

ELECTRICAL SPECIFICATIONS

LCM600L Performance Curves

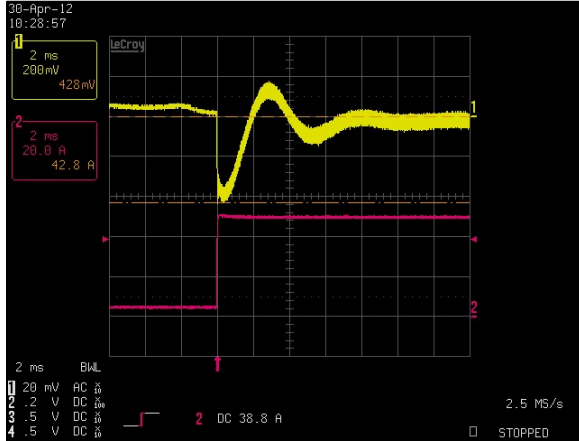

Figure 7: LCM600L Transient Response - Vo Deviation (low to high)
 10% to 100% load change 1A/uS slew rate Vin = 230Vac
 Ch 1: Vo Ch 2: Io

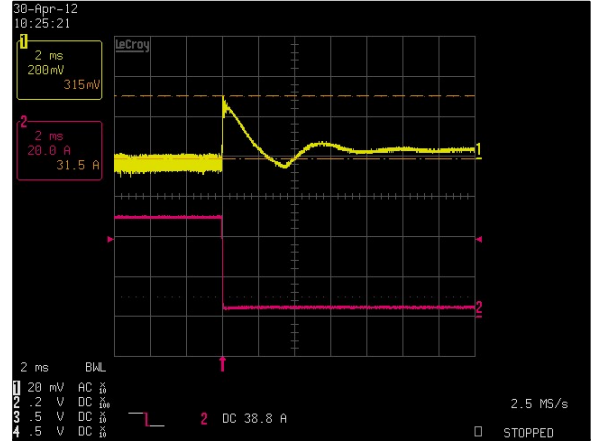

Figure 8: LCM600L Transient Response - Vo Deviation (high to low)
 100% to 10% load change 1A/uS slew rate Vin = 230Vac
 Ch 1: Vo Ch 2: Io

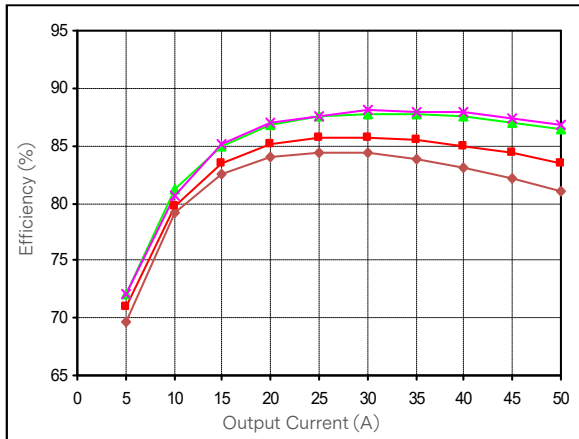

Figure 9: LCM600L Efficiency Curves @ 25 degC,
 ◆ 90 Vac ◆ 115 Vac ◆ 230 Vac ◆ 264 Vac
 Loading: Vo = 10% increment to 50A, I_{SB} = 0A (5V)

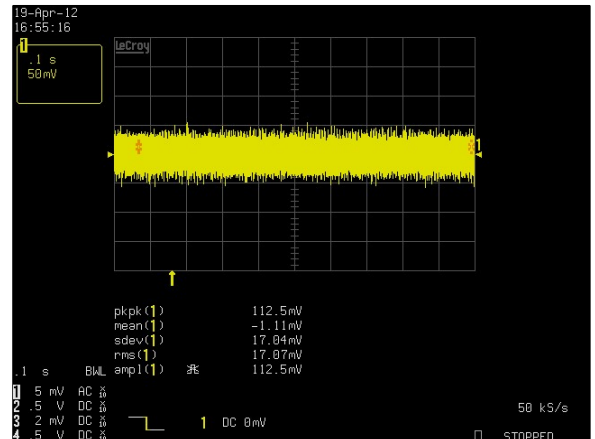

Figure 10: LCM600L Ripple and Noise Measurement - Vin = 90Vac
 Full Load: Io = 50A (12V), I_{SB} = 2A (5V)
 Ch 1: Vo

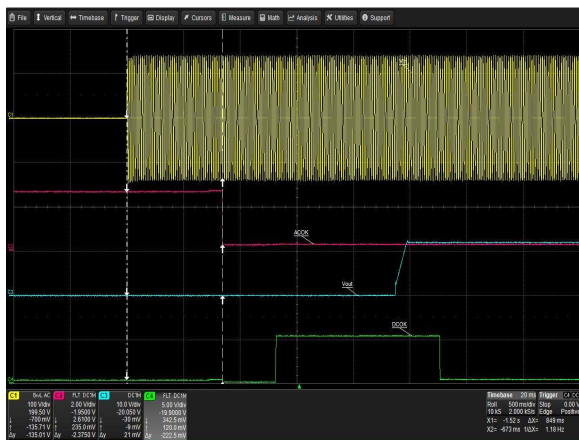

Figure 11: LCM600L ACOK Signal Turn-on Delay - Vin = 100Vac
 Load: Io = 2A (12V), I_{SB} = 0A (5V)
 Ch 1: AC Mains Ch 2: ACOK Ch 3: Vo Ch 4: DCOK

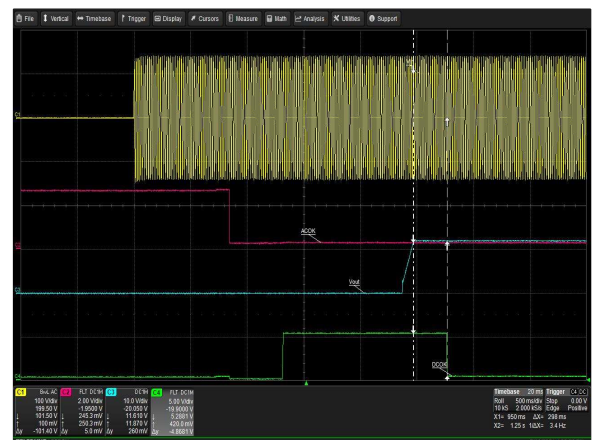

Figure 12: LCM600L DCOK Signal Turn-on Delay - Vin = 100Vac
 Load: Io = 2A (12V), I_{SB} = 0A (5V)
 Ch 1: AC Mains Ch 2: ACOK Ch 3: Vo Ch 4: DCOK

ELECTRICAL SPECIFICATIONS

LCM600L Performance Curves

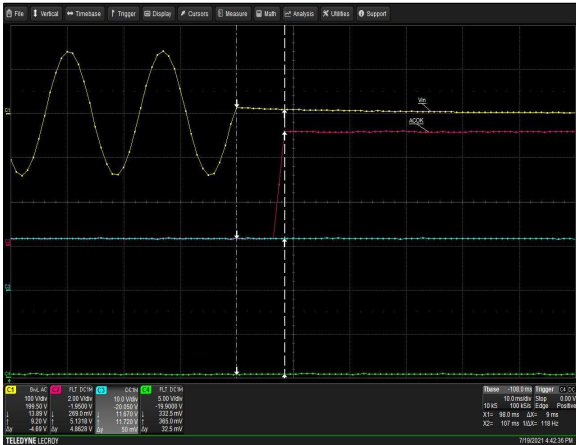

Figure 13: LCM600L ACOK Signal Turn-off Delay - Vin = 100Vac
 Load: Io = 2A (12V), I_{SB} = 0A (5V)
 Ch 1: AC Mains Ch 2: ACOK Ch 3: Vo Ch 4: DCOK

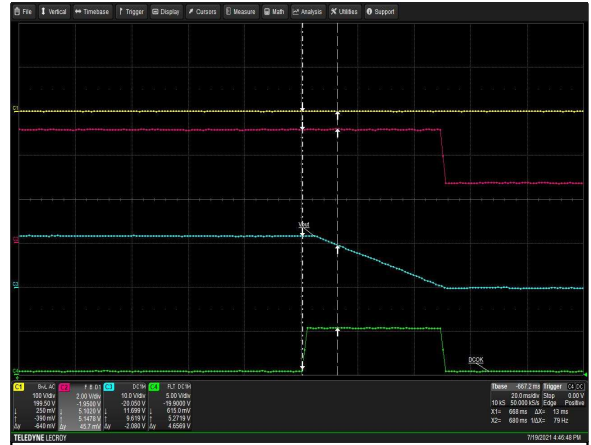

Figure 14: LCM600L DCOK Signal Turn-off Delay - Vin = 100Vac
 Load: Io = 2A (12V), I_{SB} = 0A (5V)
 Ch 1: AC Mains Ch 2: ACOK Ch 3: Vo Ch 4: DCOK

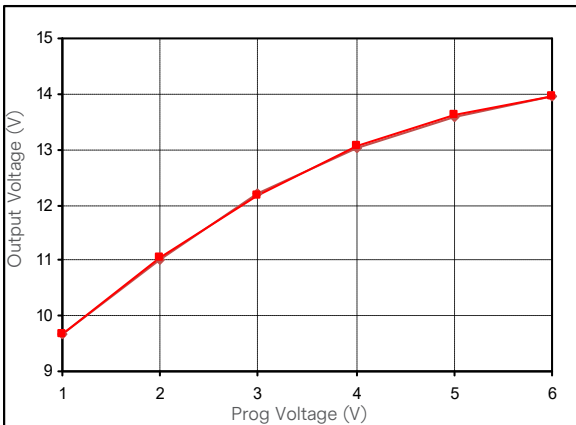

Figure 15: LCM600L Output Voltage Adjustment by Vprog @ 25 degC
 ◆ 115 Vac ◆ 230 Vac
 Loading: I_o = 0A (12V), I_{SB} = 0A (5V)

ELECTRICAL SPECIFICATIONS

LCM600N Performance Curves

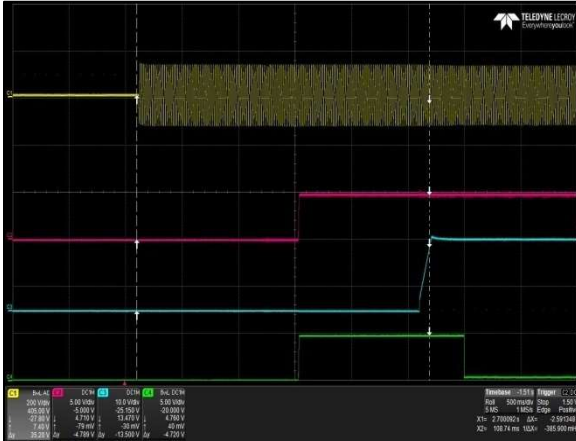

Figure 16: LCM600N Turn-on Delay via AC Mains - Vin = 90Vac
 Full Load: Io = 40A (15V), I_{SB} = 2A (5V)
 Ch 1: AC Mains Ch 2: V_{SB} Ch 3: Vo Ch 4: POWER GOOD



Figure 17: LCM600N Turn-on Delay via INH_EN - Vin = 90Vac
 Full Load: Io = 40A (15V), I_{SB} = 2A (5V)
 Ch 1: AC Mains Ch 2: INH_EN Ch 3: Vo Ch 4: POWER GOOD



Figure 18: LCM600N Hold-up Time - Vin = 90Vac / 63Hz / 0°
 Full Load: Io = 40A (15V), I_{SB} = 2A (5V)
 Ch 1: AC Mains Ch 2: V_{SB} Ch 3: Vo Ch 4: POWER GOOD

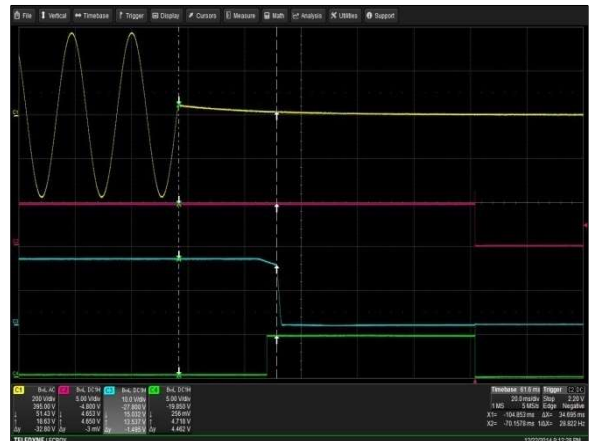

Figure 19: LCM600N Hold-up Time - Vin = 264Vac / 47Hz / 0°
 Full Load: Io = 40A (15V), I_{SB} = 2A (5V)
 Ch 1: AC Mains Ch 2: V_{SB} Ch 3: Vo Ch 4: POWER GOOD

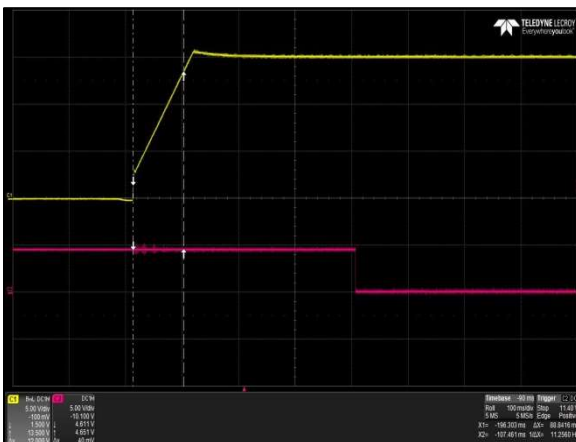

Figure 20: LCM600N Output Voltage Startup Characteristic
 Vin = 90Vac Full Load: Io = 40A (15V), I_{SB} = 2A (5V)
 Ch 1: Vo Ch 2: POWER GOOD



Figure 21: LCM600N Turn-off Characteristic via INH_EN
 Full Load: Io = 40A (15V), I_{SB} = 2A (5V)
 Ch 1: INH_EN Ch 2: Vo Ch 3: POWER GOOD

ELECTRICAL SPECIFICATIONS

LCM600N Performance Curves

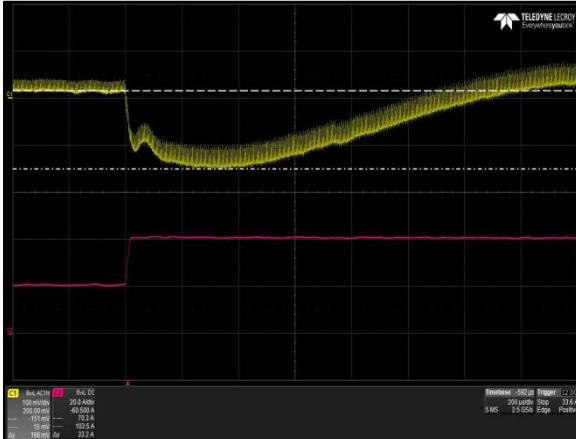

Figure 22: LCM600N Transient Response - Vo Deviation (low to high)
 10% to 100% load change 1A/uS slew rate Vin = 230Vac
 Ch 1: Vo Ch 2: Io

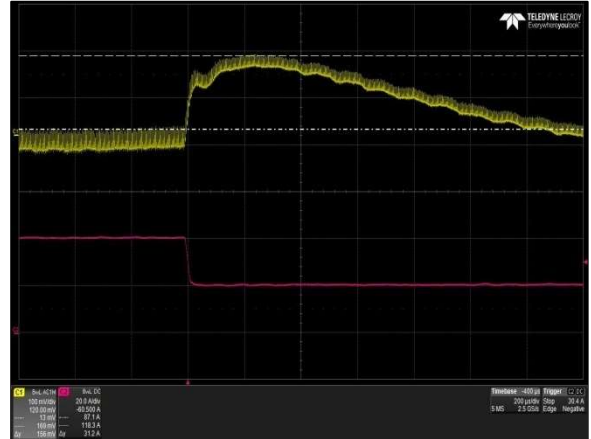

Figure 23: LCM600N Transient Response - Vo Deviation (high to low)
 100% to 10% load change 1A/uS slew rate Vin = 230Vac
 Ch 1: Vo Ch 2: Io

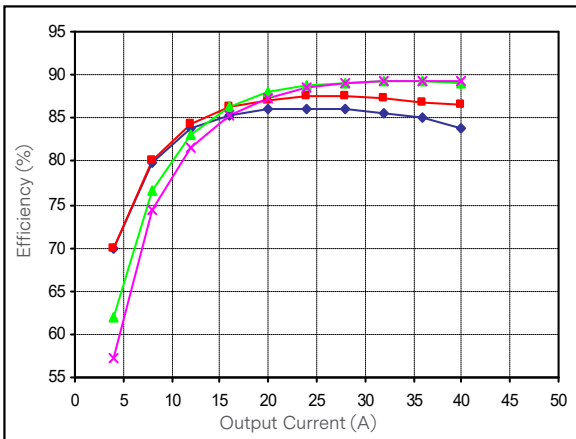

Figure 24: LCM600N Efficiency Curves @ 25 degC
 ◆ 90 Vac ■ 115 Vac ▲ 230 Vac ✕ 264 Vac
 Loading: Vo = 10% increment to 40A, I_{SB} = 0A (5V)

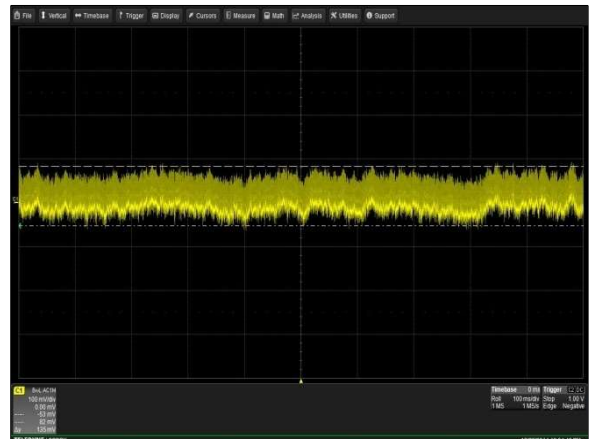

Figure 25: LCM600N Ripple and Noise Measurement
 Vin = 90Vac Load: Io = 40A (15V), I_{SB} = 2A (5V)
 Ch 1: Vo

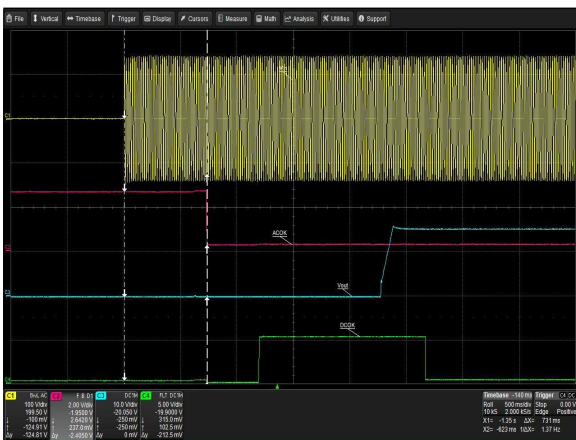

Figure 26: LCM600N ACOK Signal Turn-on Delay - Vin = 100Vac
 Load: Io = 2A (12V), I_{SB} = 0A (5V)
 Ch 1: AC Mains Ch 2: ACOK Ch 3: Vo Ch 4: DCOK

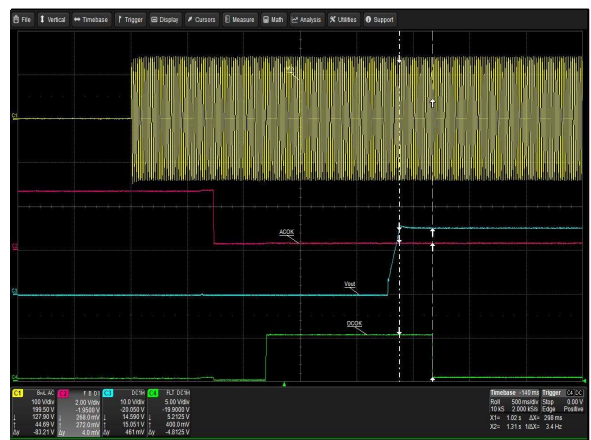

Figure 27: LCM600N ACOK Signal Turn-on Delay - Vin = 100Vac
 Load: Io = 2A (12V), I_{SB} = 0A (5V)
 Ch 1: AC Mains Ch 2: ACOK Ch 3: Vo Ch 4: DCOK

ELECTRICAL SPECIFICATIONS

LCM600N Performance Curves



Figure 28: LCM600N ACOK Signal Turn-off Delay - $V_{in} = 100V_{ac}$
 Load: $I_o = 2A (12V)$, $I_{SB} = 0A (5V)$
 Ch 1: AC Mains Ch 2: ACOK Ch 3: V_o Ch 4: DCOK



Figure 29: LCM600N DCOK Signal Turn-off Delay - $V_{in} = 100V_{ac}$
 Load: $I_o = 2A (12V)$, $I_{SB} = 0A (5V)$
 Ch 1: AC Mains Ch 2: ACOK Ch 3: V_o Ch 4: DCOK

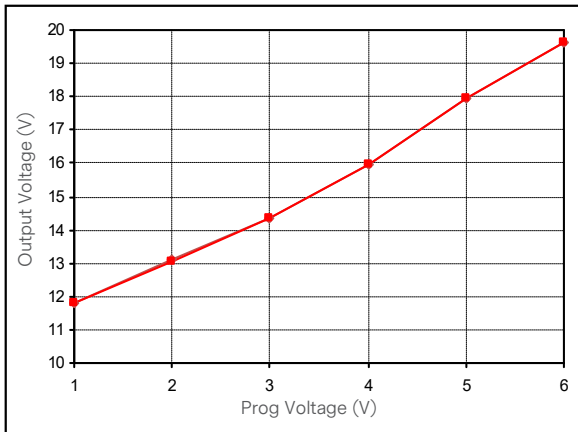

Figure 30: LCM600N Output Voltage Adjustment by V_{prom} @ 25 degC
 Loading: $I_o = 0A (15V)$, $I_{SB} = 0A (5V)$

ELECTRICAL SPECIFICATIONS

LCM600Q Performance Curves

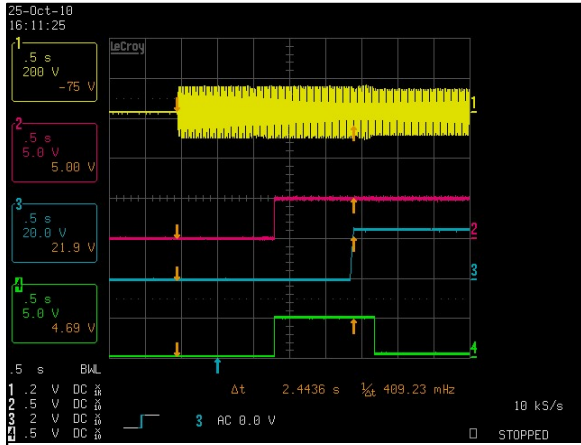

Figure 31: LCM600Q Turn-on delay via AC mains - Vin = 90Vac
 Full Load: Io = 25A (24V), I_{SB} = 2A (5V)
 Ch 1: AC Mains Ch 2: V_{SB} Ch 3: Vo Ch 4: POWER GOOD

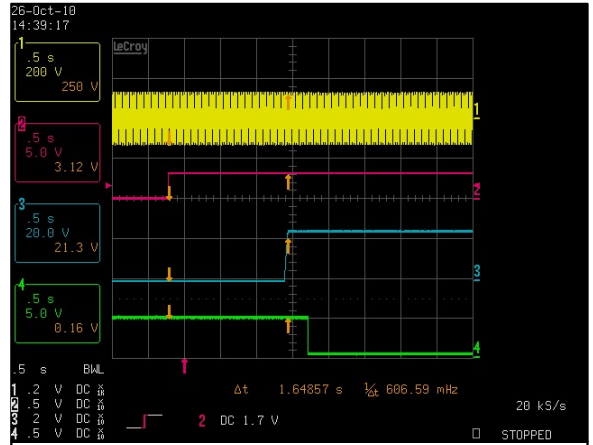

Figure 32: LCM600Q Turn-on delay via INH_EN - Vin = 90Vac
 Full Load: Io = 25A (24V), I_{SB} = 2A (5V)
 Ch 1: AC Mains Ch 2: INH_EN Ch 3: Vo Ch 4: POWER GOOD

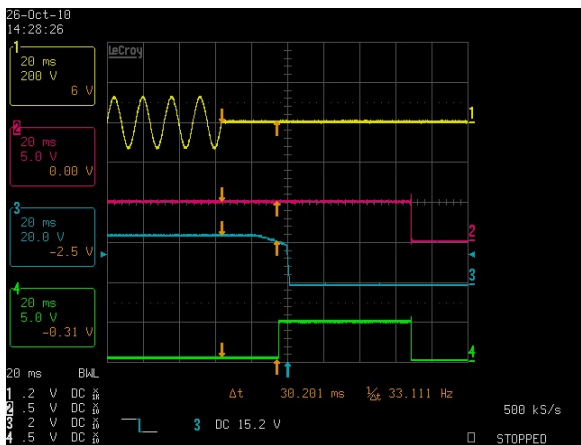

Figure 33: LCM600Q Hold-up Time - Vin = 90Vac / 63Hz / 0°
 Full Load: Io = 25A (24V), I_{SB} = 2A (5V)
 Ch 1: AC Mains Ch 2: V_{SB} Ch 3: Vo Ch 4: POWER GOOD

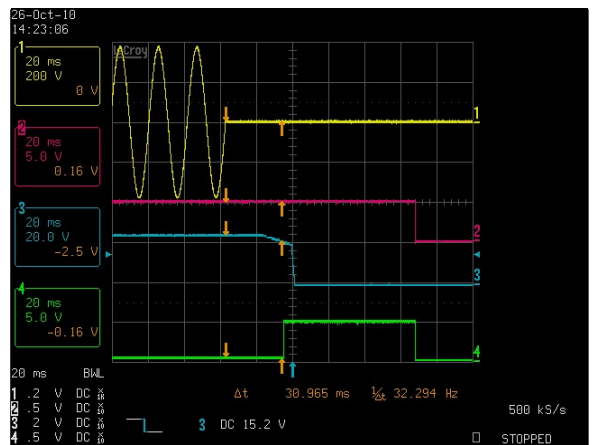

Figure 34: LCM600Q Hold-up Time - Vin = 264Vac / 47Hz / 0°
 Full Load: Io = 25A (24V), I_{SB} = 2A (5V)
 Ch 1: AC Mains Ch 2: V_{SB} Ch 3: Vo Ch 4: POWER GOOD

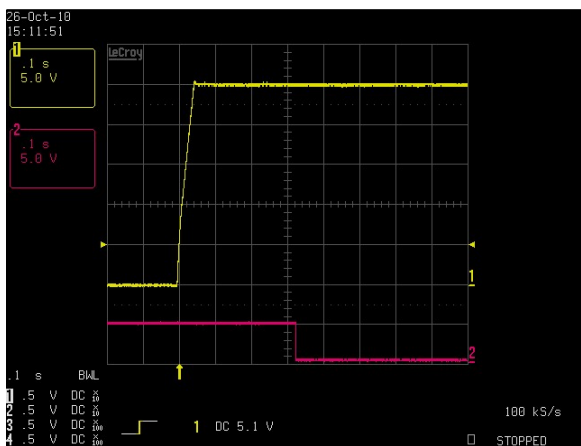

Figure 35: LCM600Q Output Voltage Startup Characteristic
 Vin = 90Vac Full Load: Io = 25A (24V), I_{SB} = 2A (5V)
 Ch 1: Vo Ch 2: POWER GOOD

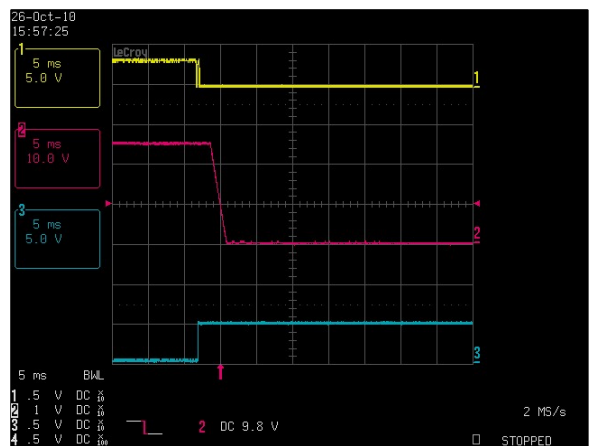
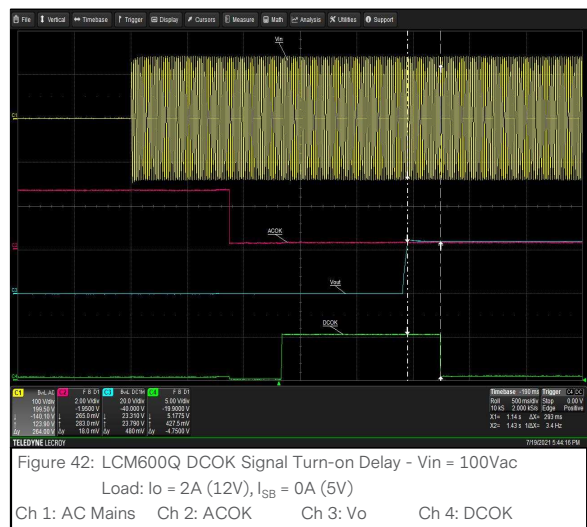
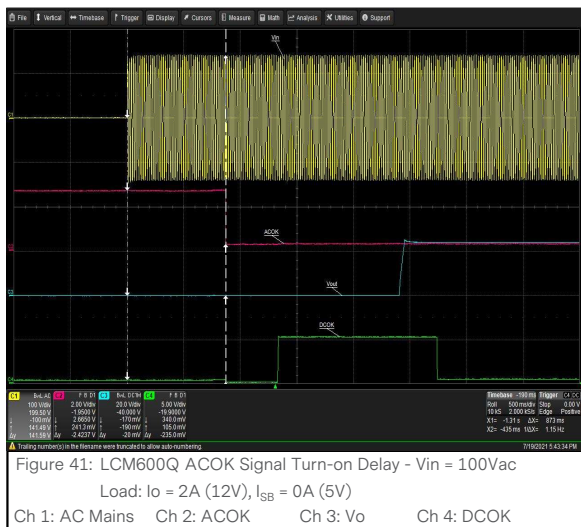
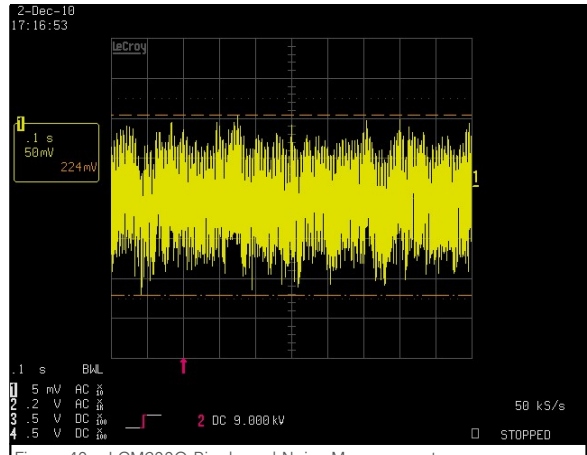
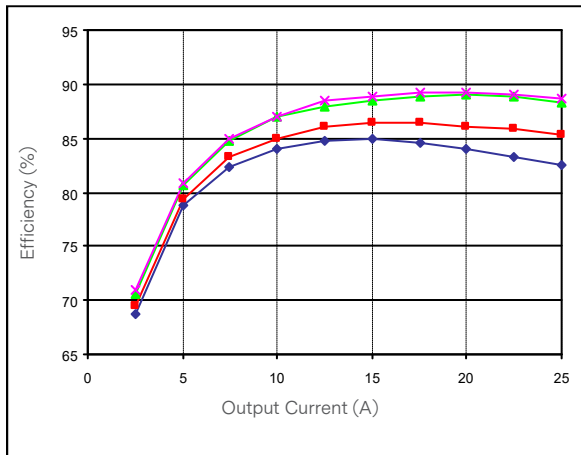
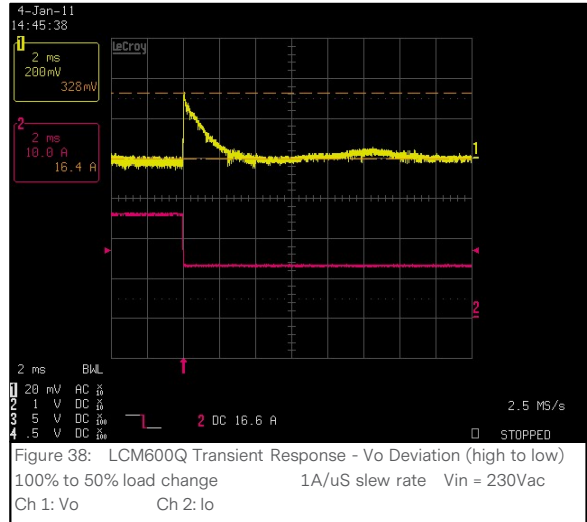
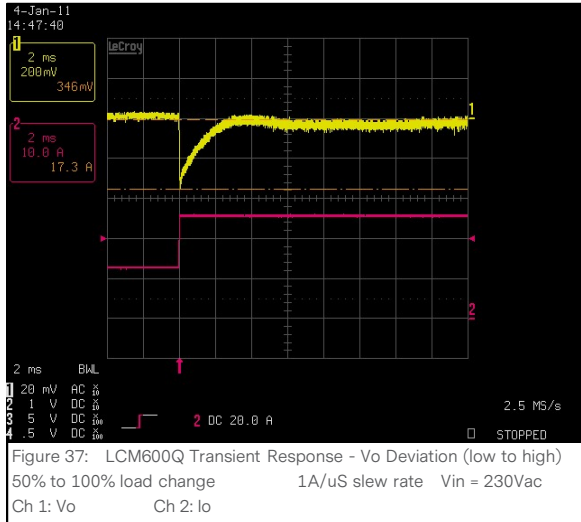

Figure 36: LCM600Q Turn Off Characteristic via INH_EN
 Full Load: Io = 25A (24V), I_{SB} = 2A (5V)
 Ch 1: INH_EN Ch 2: Vo Ch 3: POWER GOOD

ELECTRICAL SPECIFICATIONS

LCM600Q Performance Curves



ELECTRICAL SPECIFICATIONS

LCM600Q Performance Curves

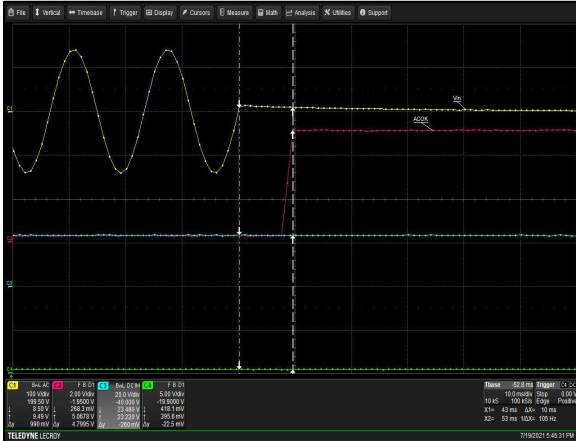

Figure 43: LCM600Q ACOK Signal Turn-off Delay - $V_{in} = 100V_{ac}$
 Load: $I_o = 2A$ (12V), $I_{SB} = 0A$ (5V)
 Ch 1: AC Mains Ch 2: ACOK Ch 3: V_o Ch 4: DCOK



Figure 44: LCM600Q DCOK Signal Turn-off Delay - $V_{in} = 100V_{ac}$
 Load: $I_o = 2A$ (12V), $I_{SB} = 0A$ (5V)
 Ch 1: AC Mains Ch 2: ACOK Ch 3: V_o Ch 4: DCOK

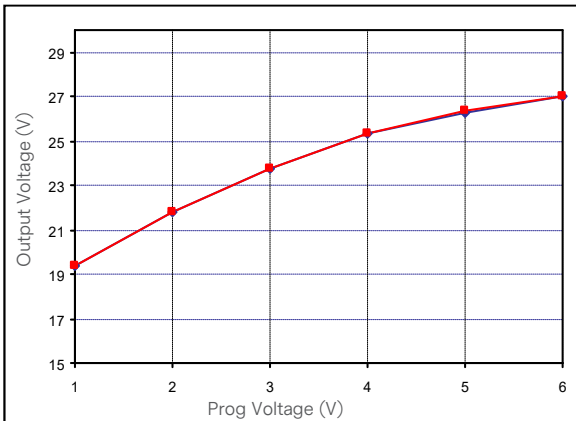

Figure 45: LCM600Q Output Voltage Adjustment by V_{prom} @ 25 degC
 ◆ 115 Vac ◆ 230 Vac
 Loading: $I_o = 0A$ (24V), $I_{SB} = 0A$ (5V)

ELECTRICAL SPECIFICATIONS

LCM600U Performance Curves

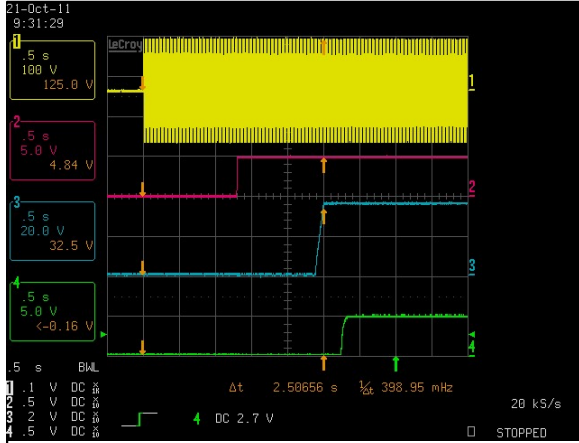

Figure 46: LCM600U Turn-on delay via AC mains - Vin = 90Vac
 Full Load: Io = 16.7A (36V), I_{SB} = 2A (5V)
 Ch 1: AC Mains Ch 2: V_{SB} Ch 3: Vo Ch 4: POWER GOOD

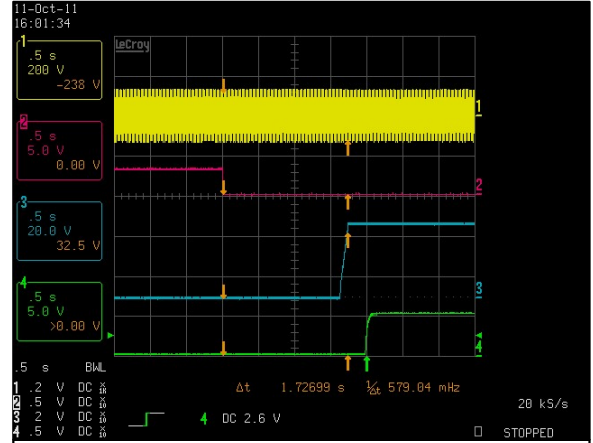

Figure 47: LCM600U Turn-on delay via INH_EN - Vin = 90Vac
 Full Load: Io = 16.7A (36V), I_{SB} = 2A (5V)
 Ch 1: AC Mains Ch 2: INH_EN Ch 3: Vo Ch 4: POWER GOOD

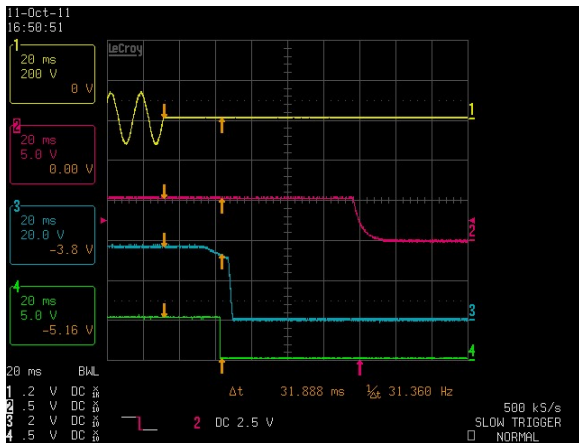

Figure 48: LCM600U Hold-up Time - Vin = 90Vac / 63Hz / 0°
 Full Load: Io = 16.7A (36V), I_{SB} = 2A (5V)
 Ch 1: AC Mains Ch 2: V_{SB} Ch 3: Vo Ch 4: POWER GOOD

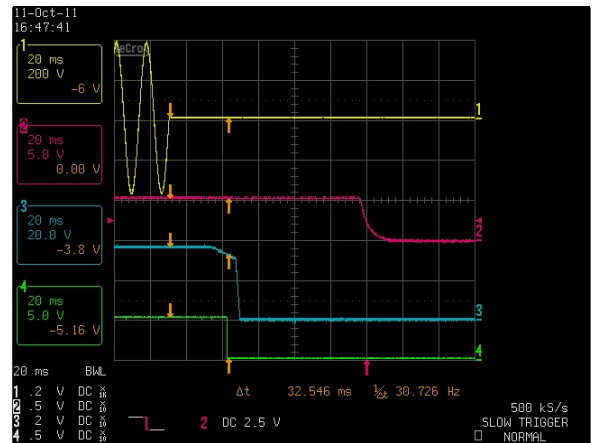

Figure 49: LCM600U Hold-up Time - Vin = 264Vac / 47Hz / 0°
 Full Load: Io = 16.7A (36V), I_{SB} = 2A (5V)
 Ch 1: AC Mains Ch 2: V_{SB} Ch 3: Vo Ch 4: POWER GOOD

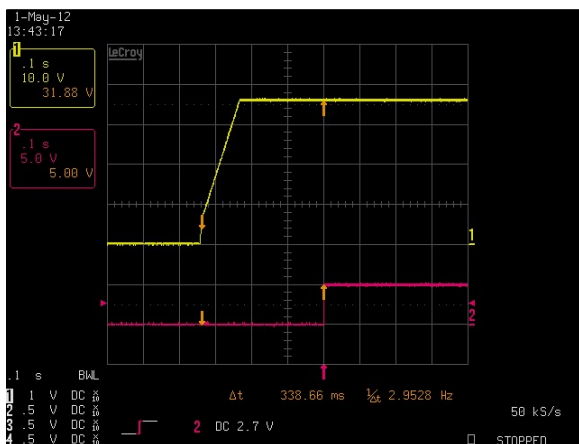

Figure 50: LCM600U Output Voltage Startup Characteristic
 Vin = 90Vac Full Load: Io = 16.7A (36V), I_{SB} = 2A (5V)
 Ch 1: Vo Ch 2: POWER GOOD

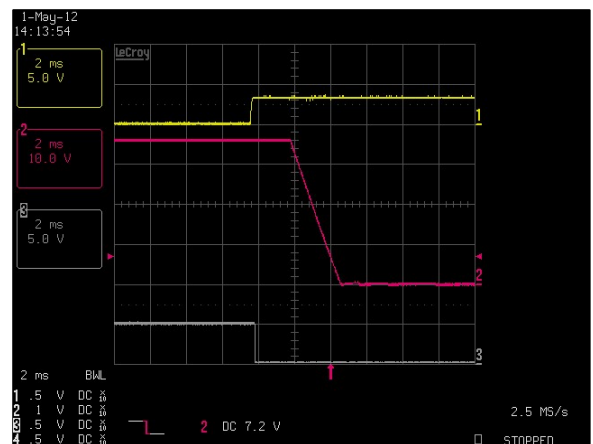

Figure 51: LCM600U Turn-off Characteristic via INH_EN
 Full Load: Io = 16.7A (36V), I_{SB} = 2A (5V)
 Ch 1: INH_EN Ch 2: Vo Ch 3: POWER GOOD

ELECTRICAL SPECIFICATIONS

LCM600U Performance Curves

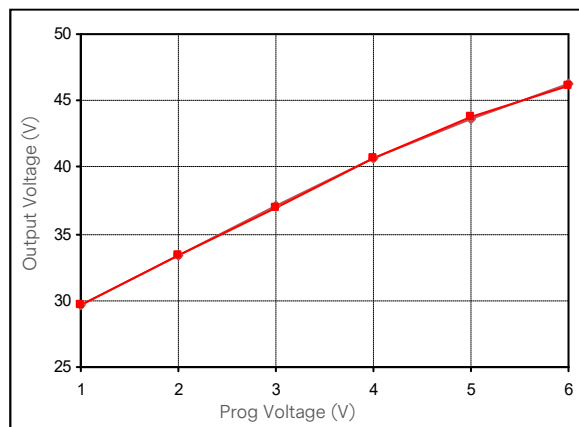
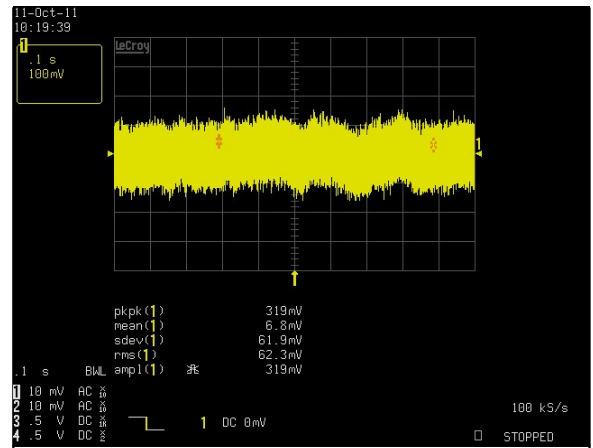
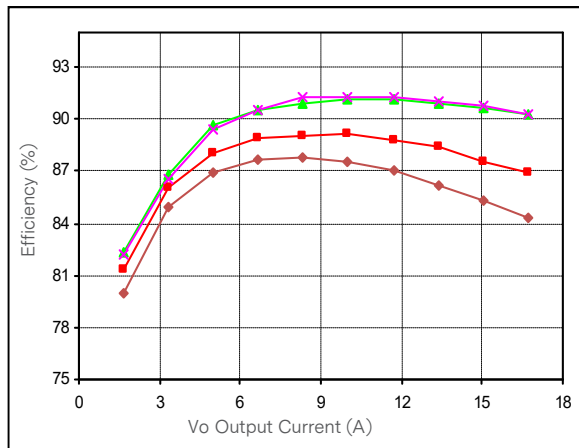
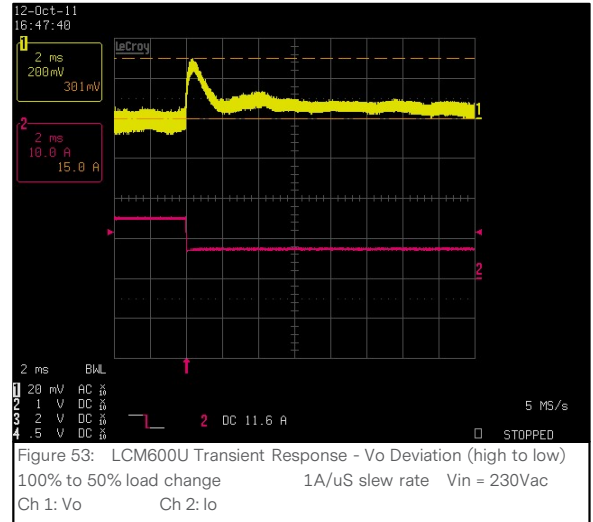
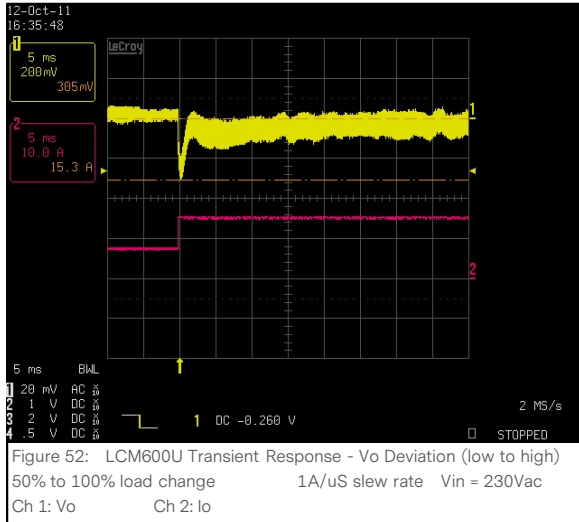
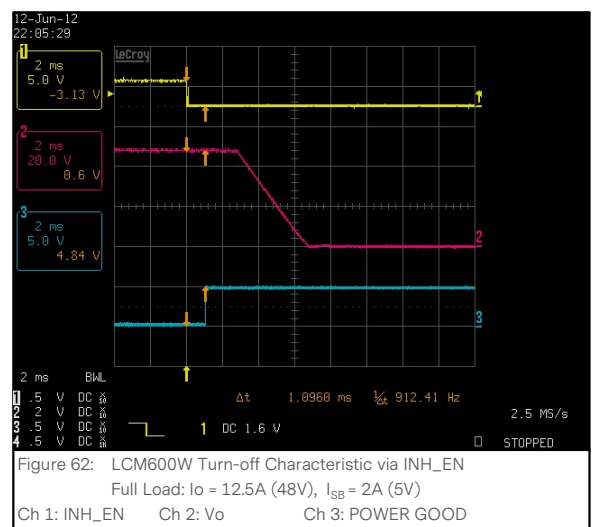
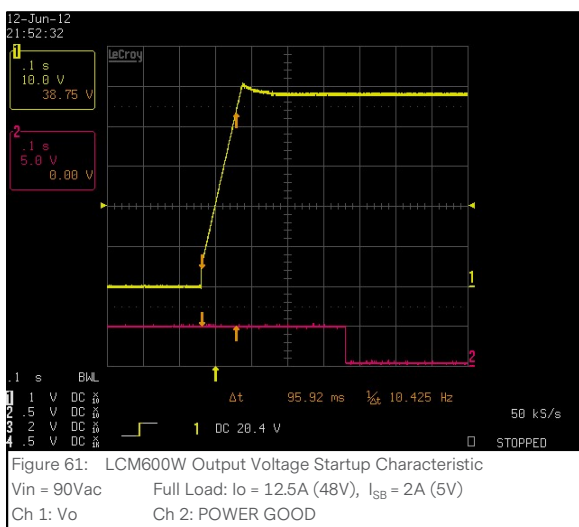
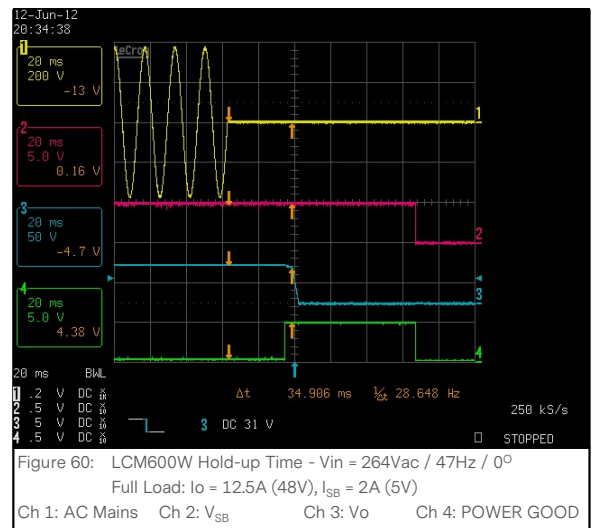
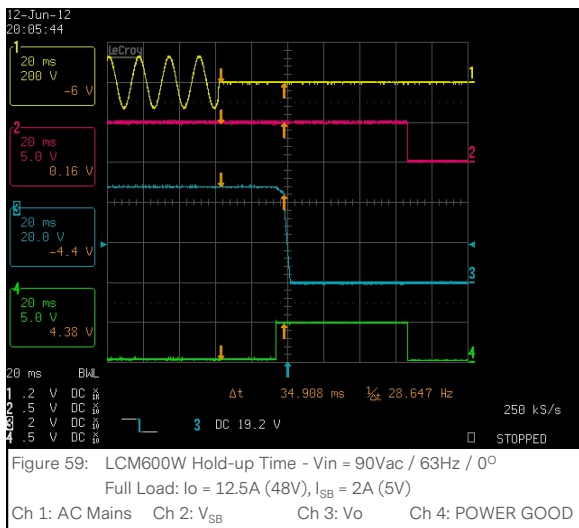
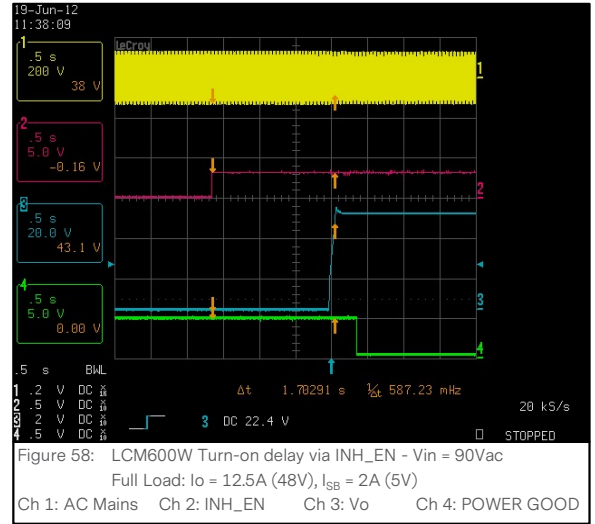
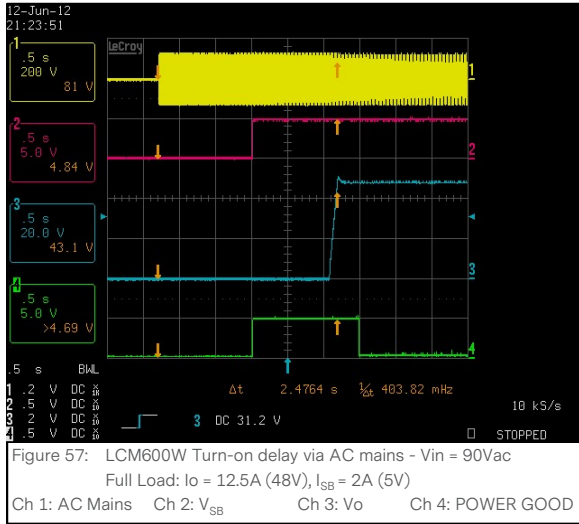

Figure 56: LCM600U Output Voltage Adjustment by Vprom @ 25 degC
Loading: Io = 0A (36V), I_{SB} = 0A (5V)

ELECTRICAL SPECIFICATIONS

LCM600W Performance Curves



ELECTRICAL SPECIFICATIONS

LCM600W Performance Curves

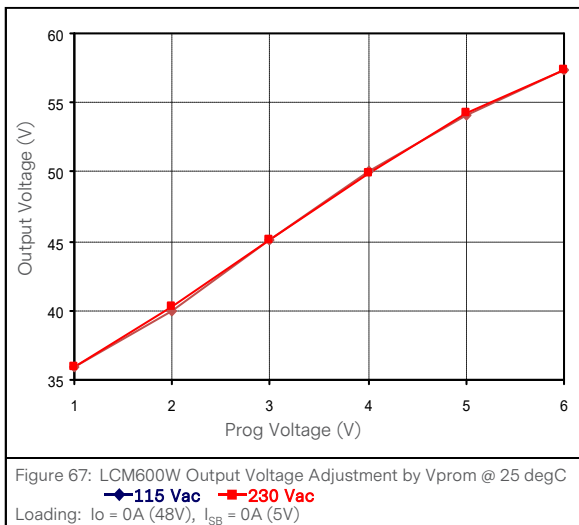
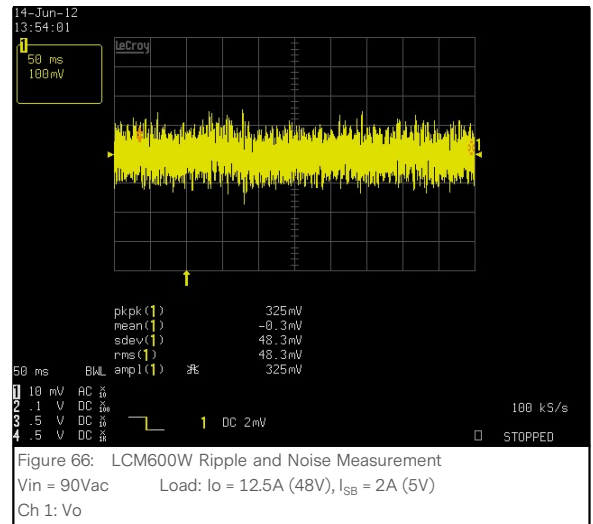
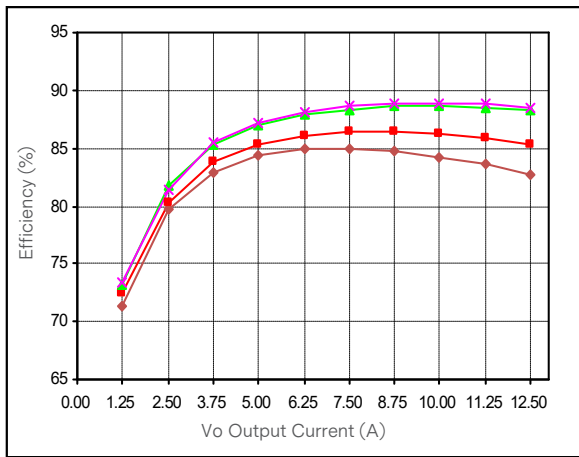
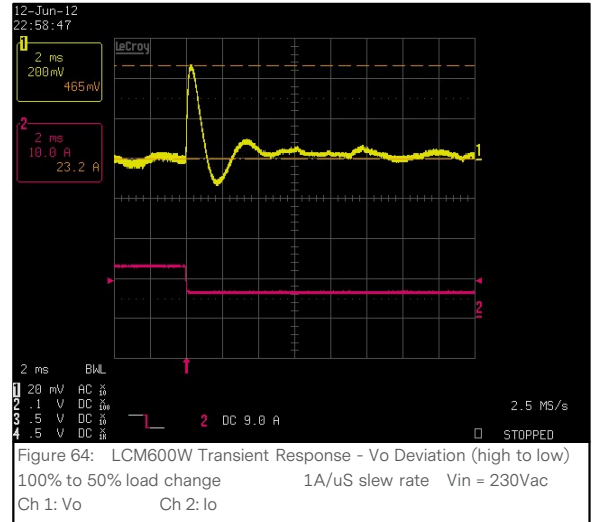
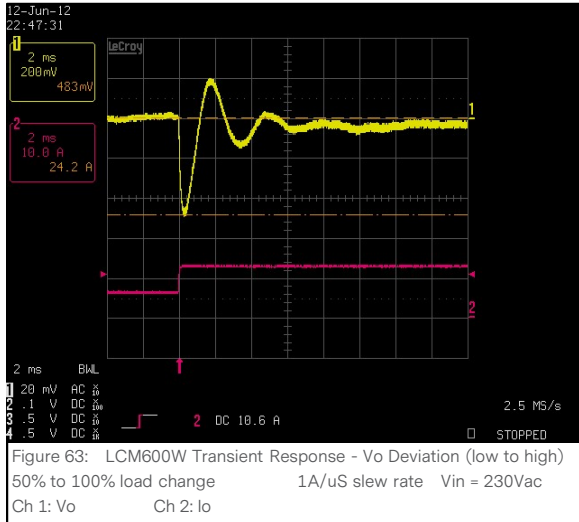

ELECTRICAL SPECIFICATIONS

Protection Function Specifications

Input Fuse

LCM600 series are equipped with an internal non user serviceable 10A High Rupturing Capacity (HRC) 250Vac fuse to IEC 127 for fault protection in both L1 and L2 lines input.

Over Voltage Protection (OVP)

The power supply latches off during output overvoltage with the AC line recycled to reset the latch.

Parameter	Min	Typ	Max	Unit
LCM600L Overvoltage	15.0	/	17.4	V
LCM600N Overvoltage	21.2	/	21.75	V
LCM600Q Overvoltage	30.0	/	34.8	V
LCM600U Overvoltage	45.0	/	52.2	V
LCM600W Overvoltage	60.0	/	69.6	V
V _{SB} Standby Overvoltage	7.0	/	7.5	V

Over Current Protection (OCP)

LCM600 series output will be in bouncing mode with a recovery time delay of 20 sec (for LCM600Q/U/W series) or 30 sec (for LCM600L/N series) when the output current hits the OCP limit provided.

Parameter	Min	Typ	Max	Unit
V _O Output Overcurrent	105	/	125	%I _{o,max}
V _{SB} Standby Overcurrent	120	/	170	%I _{SB,max}

Short Circuit Protection (SCP)

A short circuit is defined as less than 0.03 ohm resistance between the output terminals. All outputs will be protected against short circuit to ground or other outputs. No damage will result. In the event of short circuit PSU output will be in bouncing mode with a recovery delay of 20 Sec. Optional 5V standby, independent of the main output, will also be in bouncing mode once the fault occurred.

Over Temperature Protection (OTP)

The power supply will be internally protected against over temperature conditions. When the OTP circuit is activated, the power supply will shut off and will auto-recover once the OTP condition is gone. The OTP will not be triggered when PSU is running at any given operating ambient and load.

MECHANICAL SPECIFICATIONS

Mechanical Outlines (unit: mm)

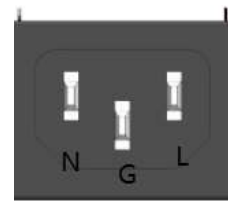
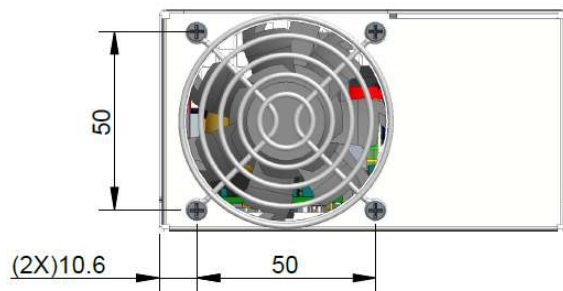
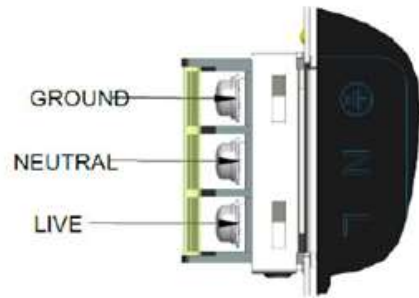
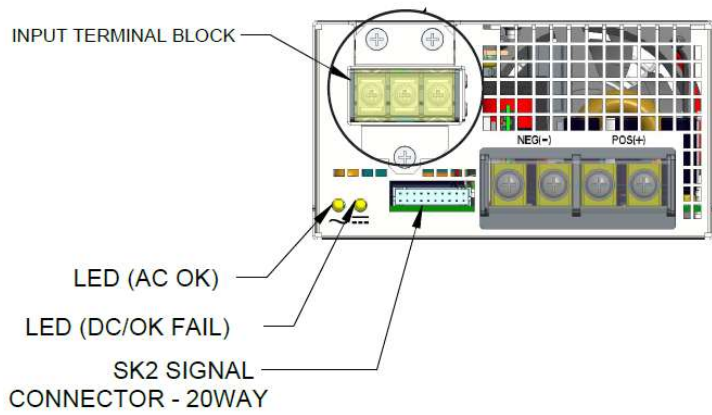

IEC
AC INLET VERSION

MECHANICAL SPECIFICATIONS

Mechanical Outlines (unit: mm)

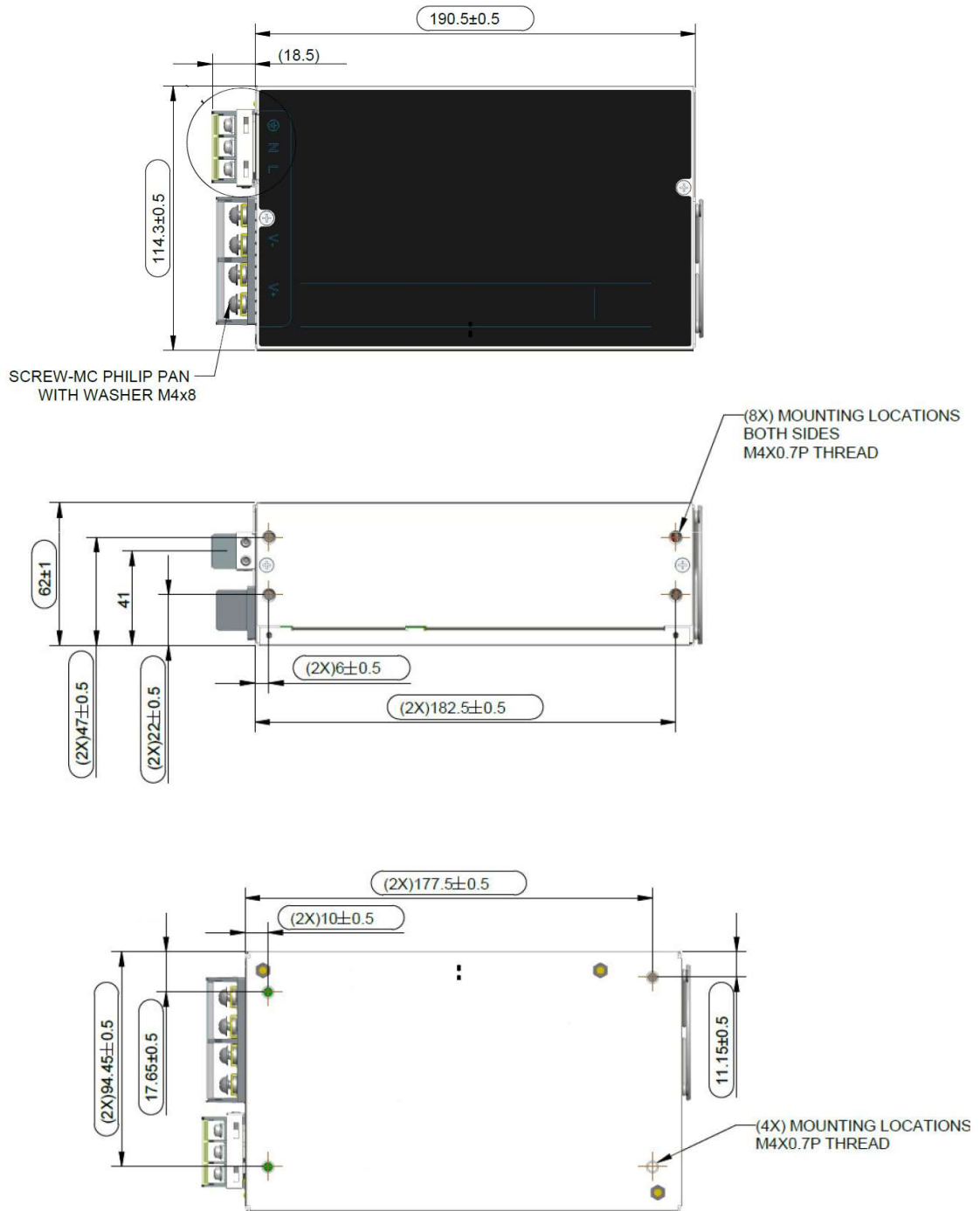

MECHANICAL SPECIFICATIONS

Mechanical Outlines - Voltage Adjustment Pot Location

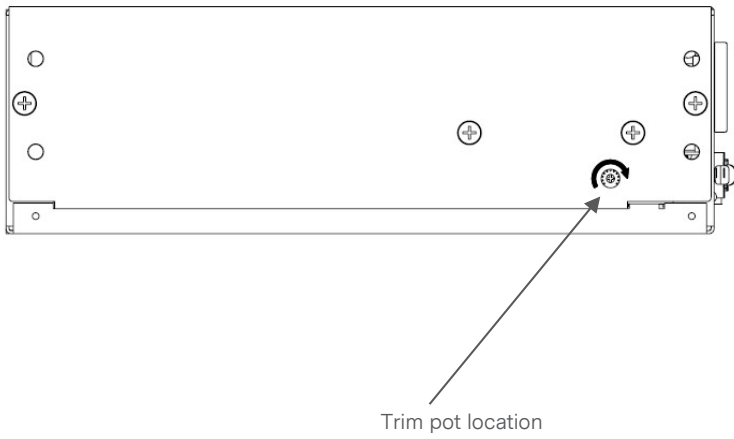

MECHANICAL SPECIFICATIONS

Connector Definitions

AC Input Connector – SK1

- Pin1 – Live
- Pin2 – Neutral
- Pin3 – Ground

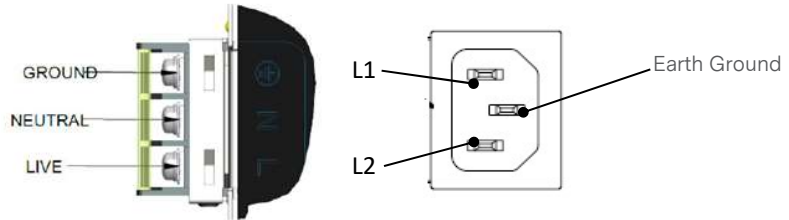

Output Connector – SK4&SK5

- SK4(&SK3) – + Main Output (Vo)
- SK5(&SK6) – Main Output Return

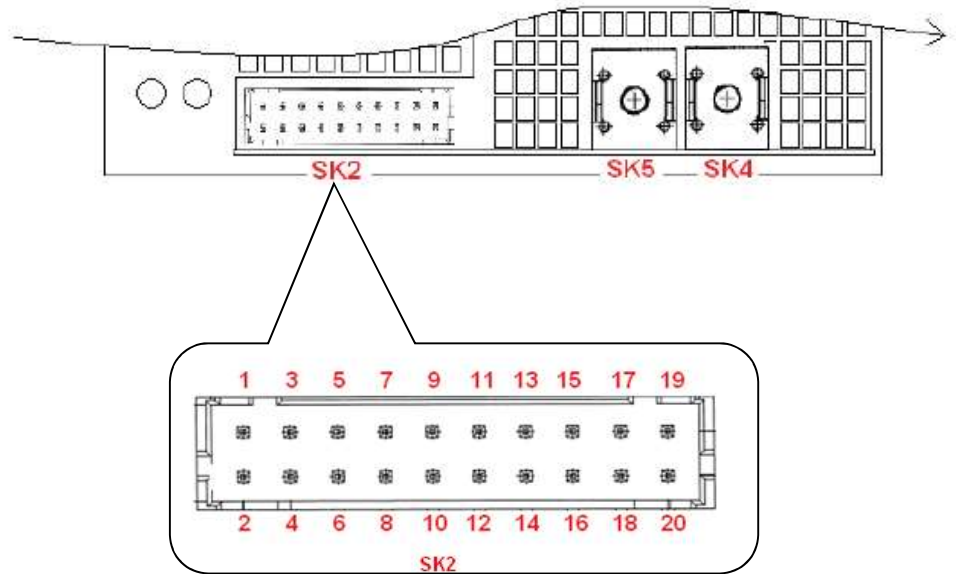

Output Connector – SK2

- Pin 1 – A2 (Not used)
- Pin 2 – -VPROG
- Pin 3 – A1 (Not used)
- Pin 4 – -Vsense
- Pin 5 – ISHARE
- Pin 6 – A0
- Pin 7 – SDA1
- Pin 8 – +VPROG
- Pin 9 – SCL1
- Pin 10 – +Vsense
- Pin 11 – 5VSB
- Pin 12 – GND
- Pin 13 – 5VSB
- Pin 14 – G_DCOK_C
- Pin 15 – GPIOA6
- Pin 16 – G_DCOK_E
- Pin 17 – GND
- Pin 18 – G_ACOK_C
- Pin 19 – INH_EN
- Pin 20 – G_ACOK_E

MECHANICAL SPECIFICATIONS

Power / Signal Mating Connectors and Pin Types

Table 4. Mating Connectors for LCM600 Series		
Reference	On Power Supply	Mating Connector or Equivalent
AC Input Connector	IEC320-C13 DINKLE (PN: DT-4C-B14W-03)	IEC320-C14 M3.5 Screw
SK2	HDR-DR 20WAY CI0120P1HD0-LF	LANDWIN (LWE PN: 2050S) Housing (LWE PN: 2053T) Contact CVILUX (CX PN: CI0120SD000) Housing (CX PN: CI01TD21PE0) Contact
SK3, SK4, SK5, SK6	500-006274-0001	Spade Terminal - Molex: BB-124-08 (19141-0058)

Accessories for SK2:

1. Order kit part number 73-788-001 for control connector interface with .3m wires attached

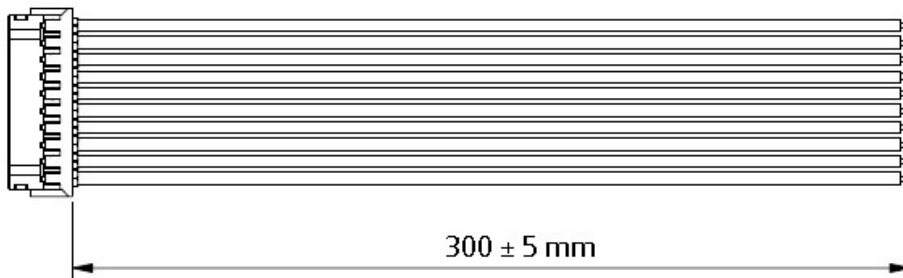

2. Order kit part number 73-788-002 for control connector interface with unloaded housing and 20 pins

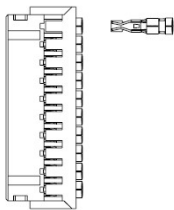

MECHANICAL SPECIFICATIONS

LED Indicator Definitions

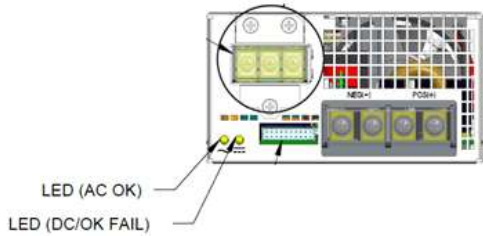

Two user-friendly LEDs for status and diagnostics show status of input power, output power and alarm condition valuable troubleshooting aid to reduce system downtime.

Conditions	LED Status	
	ACOK LED	DCOK/FAIL LED
AC present / Output On	Green	Green
No AC power to PSU	OFF	OFF
Standby mode/main output off	Green	OFF
Power supply failure	Green	OFF

MECHANICAL SPECIFICATIONS

Weight

The LCM600 series weight is 2.84lbs (1kg=2.2046lbs) maximum.

ENVIRONMENTAL SPECIFICATIONS

EMC Immunity

The LCM600 series are designed to meet the following EMC immunity specifications

Table 5. Environmental Specifications	
Document	Description
EN55032	Conducted and Radiated EMI Limits
EN6100-3-2 Harmonics	Harmonics
EN61000-3-3	Voltage Fluctuations
IEC/EN 61000-4-2	Electromagnetic Compatibility (EMC) - Testing and measurement techniques – Electrostatic discharge immunity test. +/-8KV air, +/-15KV contact discharge, Level 3
IEC/EN 61000-4-3	Electromagnetic Compatibility (EMC) - Testing and measurement techniques, Radiated, radio-frequency, electromagnetic field immunity test. 80 – 600 MHz,10V/m, AM 80% (1KHz),900MHz, Level 3
IEC/EN 61000-4-4	Electromagnetic Compatibility (EMC) - Testing and measurement techniques, Electrical Fast Transient/Burst Immunity Test. 2KV for AC power port, 1.0KV for DC ports, I/O and signal ports, Level 3
IEC/EN 61000-4-5	Electromagnetic Compatibility (EMC) - Testing and measurement techniques – 2KV common mode and 1KV differential mode for AC ports and 0.5kV differential mode for DC power, I/O and signal ports, Level 3.
IEC/EN 61000-4-8	Power Freq Magnetic, Level 3
IEC/EN 61000-4-11	Electromagnetic Compatibility (EMC) - Testing and measurement techniques : Voltage Dips and Interruptions: 30% reduction for 500mS- Criteria B>95% reduction for 10mS, Criteria A, >95% reduction for 5000mS, Criteria C
EN55024:1998	Information Technology Equipment-Immunity Characteristics, Limits and Method of Measurements
EN61000-4-6	Conducted RFI for LCM600Q-T-409 only
EN61000-6-2	For LCM600Q-T-409 only

ENVIRONMENTAL SPECIFICATIONS

Safety Certifications

The LCM600 series are intended for inclusion in other equipment and the installer must ensure that it is in compliance with all the requirements of the end application. This product is only for inclusion by professional installers within other equipment and must not be operated as a stand alone product.

Table 6. Safety Certifications for LCM600 Series Power Supply System		
Standard	File#	Description
UL/CSA62368-1	E186249-A6047-UL-X10	US and Canada Requirements
EN62368-1	B 013890 3170 Rev. 00	European Requirements
IEC60950-1 IEC60601-1		International Electrotechnical Commission
ES60601-1/CSA C22.2 No. 60601-1	E182560-V4-S2	US and Canada Requirements
EN60601-1		European Requirements
CCC	2012010907546604	China Requirements
UKCA Mark		UK Requirements

ENVIRONMENTAL SPECIFICATIONS

EMI Emissions

The LCM600 series has been designed to comply with the Class B limits of EMI requirements of EN55032 (FCC Part 15) and CISPR 22 (EN55032) for emissions and relevant sections of EN61000 (IEC61000) for immunity.

The unit is enclosed inside a metal box, tested at 600W using resistive load with cooling fan.

Conducted Emissions

The applicable standard for conducted emissions is EN55032 (FCC Part 15). Conducted noise can appear as both differential mode and common mode noise currents. Differential mode noise is measured between the two input lines, with the major components occurring at the supply fundamental switching frequency and its harmonics. Common mode noise, a contributor to both radiated emissions and input conducted emissions, is measured between the input lines and system ground and can be broadband in nature.

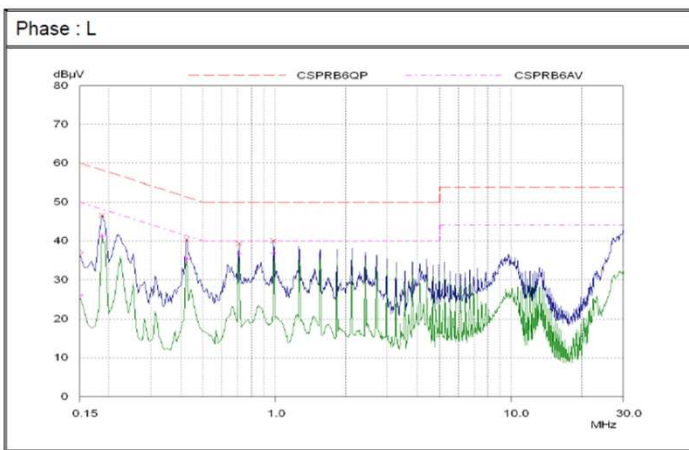

The LCM600 series power supplies have internal EMI ensure the convertors’ conducted EMI levels comply with EN55032 (FCC Part 15) Class B and EN55032 (CISPR22) Class B limits. The EMI measurements are performed with resistive loads at maximum rated loading.

Sample of EN55032 Conducted EMI Measurement at 100Vac input

Note: Red Line refers to Artesyn Quasi Peak margin, which is 6dB below the CISPR international limit. Pink Line refers to the Emerson Average margin which is 6dB below the CISPR international limit.

Table 7. Conducted EMI emission specifications of the LCM600 series

Parameter	Model	Symbol	Min	Typ	Max	Unit
FCC Part 15, class B	All	Margin	-	-	6	dB
CISPR 22 (EN55032) class B	All	Margin	-	-	6	dB

Radiated Emissions

Unlike conducted EMI, radiated EMI performance in a system environment may differ drastically from that in a stand-alone power supply. The shielding effect provided by the system enclosure may bring the EMI level from Class A to Class B. It is thus recommended that radiated EMI be evaluated in a system environment. The applicable standard is EN55032 Class A (FCC Part 15). Testing ac-dc convertors as a stand-alone component to the exact requirements of EN55032 can be difficult, because the standard calls for 1m leads to be attached to the input and outputs and aligned such as to maximize the disturbance. In such a set-up, it is possible to form a perfect dipole antenna that very few ac-dc convertors could pass. However, the standard also states that ‘an attempt should be made to maximize the disturbance consistent with the typical application by varying the configuration of the test sample.

ENVIRONMENTAL SPECIFICATIONS

Operating Temperature

The LCM600 series maximum output power (600W) can be loaded up to an ambient temperature of +50°C. Only 50% (300W) of the maximum output power can be loaded at ambient temp of +70°C. Linear derating to 50% nominal output power starts from +50°C. The elapsed time between the application of input power and the attainment steady state values requires 5 minutes warm up for -20°C to -40°C operation.

Output Power vs Operating Temperature

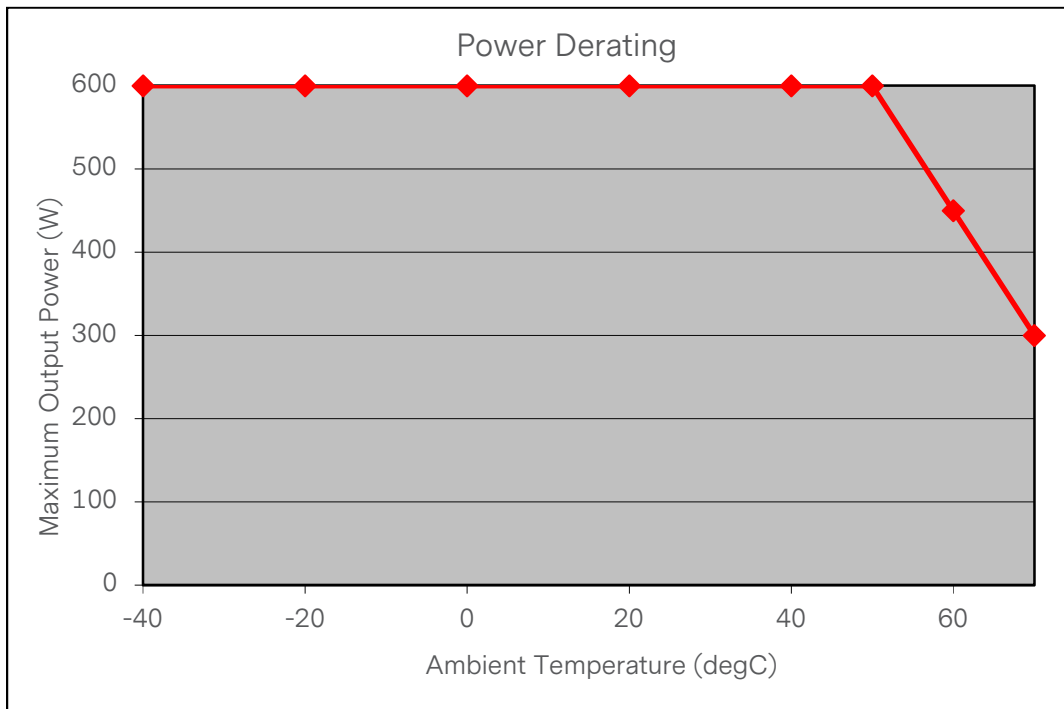

Forced Air Cooling

The LCM600 series power supply includes internal cooling fans as part of the power supply assembly to provide forced air-cooling to maintain and control temperature of devices and ambient temperature in the power supply to appropriate levels. The standard direction of airflow is from the fan side to the DC output side of the power supply.

The cooling fan is a variable speed fan. Fan will be smart based on internal temperature. Fan noise <45 dBA with 80% load @ 30°C.

ENVIRONMENTAL SPECIFICATIONS

Storage and Shipping Temperature

The LCM600 series power supply can be stored or shipped at temperatures between -40°C to +85°C and relative humidity from 10% to 95% non-condensing.

Altitude

The LCM600 series power supply will operate within specifications at altitudes up to 16404.2 feet above sea level. The power supply will not be damaged when stored at altitudes of up to 30000 feet above sea level.

Humidity

The LCM600 series power supply will operate within specifications when subjected to a relative humidity from 20% to 90% non-condensing. The LCM600 can be stored in a relative humidity from 10% to 95% non-condensing.

Vibration

The LCM600 series will pass the following vibration specifications:

Non-Operating Random Vibration

Acceleration	2.7	gRMS	
Frequency Range	10 - 2000	Hz	
Duration	20	Mins	
Direction	3 mutually perpendicular axis		
PSD Profile	FREQ (Hz)	SLOPE (dB/oct)	PSD (g ² /Hz)
	10-190	/	0.01
	190-210	-31.213	/
	210-2000	/	0.003

Operating Random Vibration

Acceleration	1.0	gRMS	
Frequency Range	10 - 500	Hz	
Duration	20	Mins	
Direction	3 mutually perpendicular axis		
PSD Profile	FREQ (Hz)	SLOPE (db/oct)	PSD (g ² /Hz)
	10-500	/	0.002

ENVIRONMENTAL SPECIFICATIONS

Shock

The LCM600 series power supply will pass the following shock specifications:

Non-Operating Half-Sine Shock

Acceleration	30	G
Duration	18	mSec
Pulse	Half-Sine	
Number of Shock	3 shock on each of 6 faces	

Operating Half-Sine Shock

Acceleration	4	G
Duration	22	mSec
Pulse	Half-Sine	
Number of Shock	3 shocks in each of 6 faces	

POWER AND CONTROL SIGNAL DESCRIPTIONS

AC Input Connector

This connector supplies the AC Mains to the LCM600 series power supply.

- Pin 1 – L1
- Pin 2 – L2
- Pin 3 – Earth Ground

Output Connectors - SK4&SK5

These pins provide the main output for the LCM600 series. The + Main Output (V_O) and the Main Output Return pins are the positive and negative rails, respectively, of the V_O main output of the LCM600 power supply. The Main Output (V_O) is electrically isolated from the power supply chassis.

- SK3&SK4 – + Main Output (V_O)
- SK5&SK6 – Main Output Return

Control Signals - SK2

The LCM600 series SK2 contains 20 pins control signal header providing analog control interface, standby power and I²C interface.

A0, A1, A2 - (Pin 6, Pin 3, Pin 1)

Please refer to “Communication Bus Descriptions” section.

-VPROG, +VPROG - (Pin 2, Pin 8)

Positive and return connection of external supply for Margin Programming. The Power supplies will have a “margin” pin which will accept a 1-6VDC signal referenced to a floating return that will program the output the entire adjustment range. The 1-6VDC signal will be limited to 10mA sinking current.

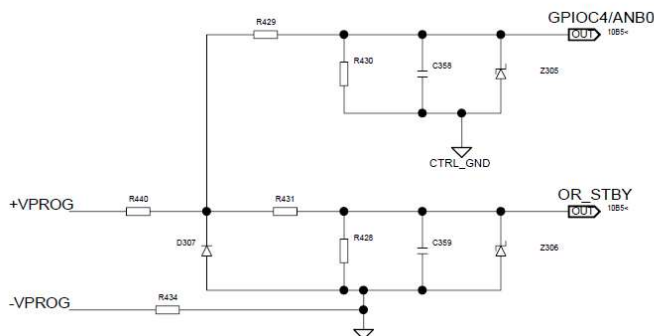

-Vsense, +Vsense - (Pin 4, Pin 10)

This remote sense circuit will be designed to compensate for a power path drop around the entire loop of 0.5 volt. These pins should be connected as close to the loading as possible, If left open, the power supply will regulate the voltage at its output terminals but the voltage level at the load may go lower than the guaranteed spec.

POWER AND CONTROL SIGNAL DESCRIPTIONS

ISHARE - (Pin 5)

The main output will have active load sharing. The output will share within 10% at full load. All current sharing functions are implemented internal to the power supply by making use of the ISHARE signal. The system connects the ISHARE lines between the power supplies. The supplies must be able to load share with up to 10 power supplies in parallel. The I2C Line should be connected separately when the number of units in parallel is more than 8.

SDA1, SCL1, GND - (Pin 7, Pin 9, Pin 17)

Please refer to “Communication Bus Descriptions” section.

5VSB, GND - (Pin 11, Pin 12, Pin 13)

The LCM600 series power supply provides a regulated 5 volt 2 amp auxiliary output voltage to power critical circuitry that must remain active regardless of the on/off status of the power supply’s main output. The standby voltage is available whenever a valid AC input voltage is applied to the unit.

G_DCOK_C, G_DCOK_E - (Pin 14, Pin 16)

G_DCOK_C is a power good signal and will be pulled LOW by the power supply to indicate that both the outputs are above the regulation limits of the power supply. When any output voltage falls below regulation limits or when AC power has been removed for a time sufficiently long so that power supply operation is no longer guaranteed, G_DCOK_C will be de-asserted to a HIGH state. Connect 4.7K resistor on G_DCOK_C to PSU’s 5V stand-by.

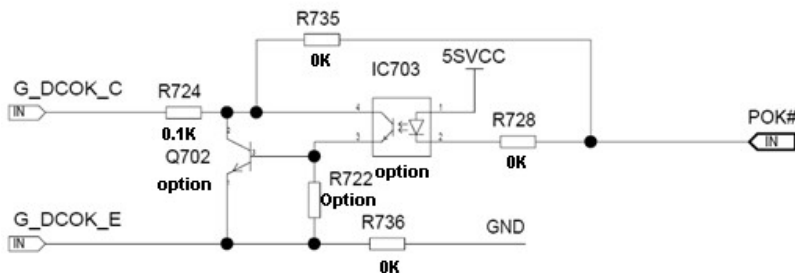

GPIOA6 - (Pin 15)

EEPROM Write Protect

G_ACOK_C, G_ACOK_E - (Pin 18, Pin 20)

G-ACOK_C signal is used to indicate presence of AC input to the power supply. A logic “Low” level on this signal will indicate AC input to the power supply is present. A Logic “High” on this signal will indicate a loss of AC input to the power supply. Connect 4.7K resistor on G_ACOK_C to external 5V power.

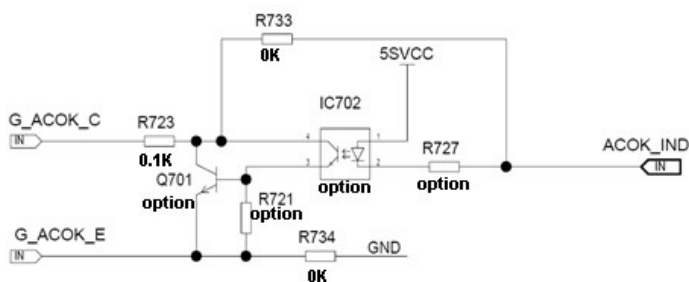

POWER AND CONTROL SIGNAL DESCRIPTIONS

INH_EN - (Pin 19)

This signal is required to remotely turn on/off the power supply. When INH_EN is shorted to secondary common, the PSU main output shall turn OFF, otherwise the main output is ON.

COMMUNICATION BUS DESCRIPTIONS

I²C Bus Signals

The LCM600 series contains enhanced monitor and control functions implemented via the I²C bus. The LCM600 series I²C functionality (PMBus™ and FRU data) can be accessed via the output connector control signals. The communication bus is powered either by the internal 3.3V supply or from an external power source connected to the standby output (ie: accessing an unpowered power supply as long as the standby output of another power supply connected in parallel is on).

If units are connected in parallel or in redundant mode, the standby outputs must be connected together in the system. Otherwise, the I²C bus will not work properly when a unit is inserted into the system without the AC source connected.

Note: PMBus™ functionality can be accessed only when the PSU is powered-up. Guaranteed communication I²C speed is 100KHz.

SDA1, SCL1 (I²C Data and Clock Signals) - (pin7, pin 9)

I²C serial data and clock bus - these pins are internally pulled up to internal 3.3V supply with a 4.7K ohm resistor. These pins must be pulled-up in the system by an 2.2K ohm resistor to the 3.3V supply.

A0, A1, A2 (I²C Address BIT 0, BIT1, BIT2 Signals) - (pin6, pin3, pin1)

A1, A2 input pins not be used. The address line A0 to the power supply addresses for FRU data and PMBus™ data communication. This allows the system to assign different addresses for each power supply. During I²C communication between system and power supplies, the system will be the master and power supplies will be slave.

They are internally pulled up to internal 5V supply with 2K ohm resistors and voltage limited to 2.7V with zener diodes.

I²C Bus Communication Interval

The interval between two consecutive I²C communications to the power supply should be at least 50ms to ensure proper monitoring functionality.

I²C Bus Signal Integrity

The noise on the I²C bus (SDA, SCL lines) due to the power supply will be less than 500mV peak-to-peak. This noise measurement should be made with an oscilloscope bandwidth limited to 100MHz. Measurements should be made at the power supply output connector with 2.2K ohm resistors pulled up to StandBy Output and 100pf ceramic capacitors to StandBy Output Return.

The noise on the address lines A0 will be less than 100mV peak-to-peak. This noise measurement should be made at the power supply output connector.

COMMUNICATION BUS DESCRIPTIONS

I²C Bus Internal Implementation, Pull-ups and Bus Capacitances

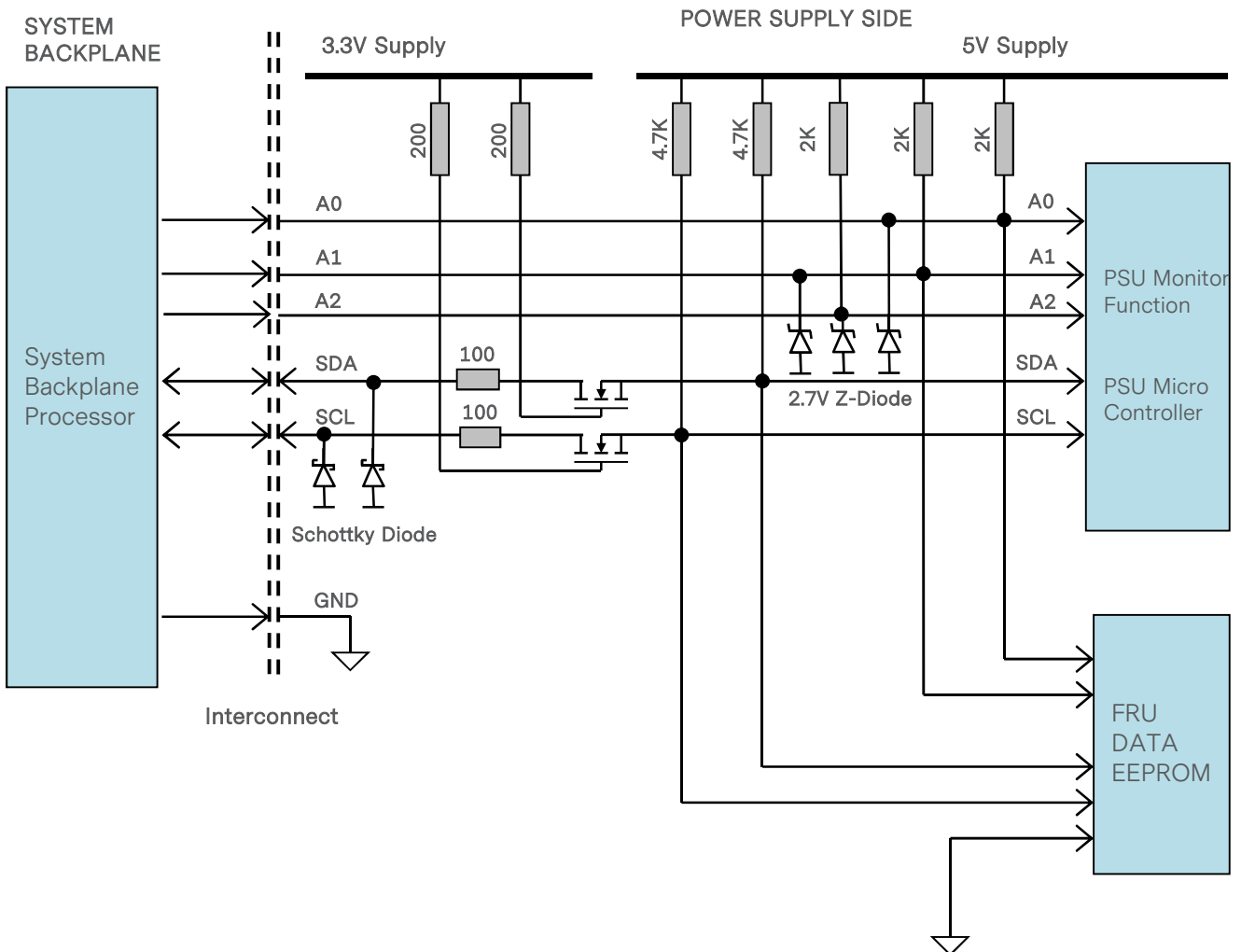

I²C Bus - Recommended external pull-ups

Electrical and interface specifications of I²C signals (referenced to standby output return pin, unless otherwise indicated):

Parameter	Condition	Symbol	Min	Type	Max	Unit
SDA, SCL internal pull-up resistor		R_{int}	-	4.7	-	Kohm
SDA, SCL internal bus capacitance		C_{int}	-	0	-	pF
Recommended external pull-up resistor 1 PSU	1 PSU	R_{ext}	-	2.2K	-	ohm
	2 PSU		-	1.1K	-	ohm

COMMUNICATION BUS DESCRIPTIONS

Logic Levels

LCM600 series power supply I²C communication bus will respond to logic levels as per below:

Logic High: 5.1V nominal (Spec is 2.1V to 5.5V)**

Logic Low: 500mV nominal (Spec is 800mV max)**

**Note: Philips™ I²C adapter was used.

Timings

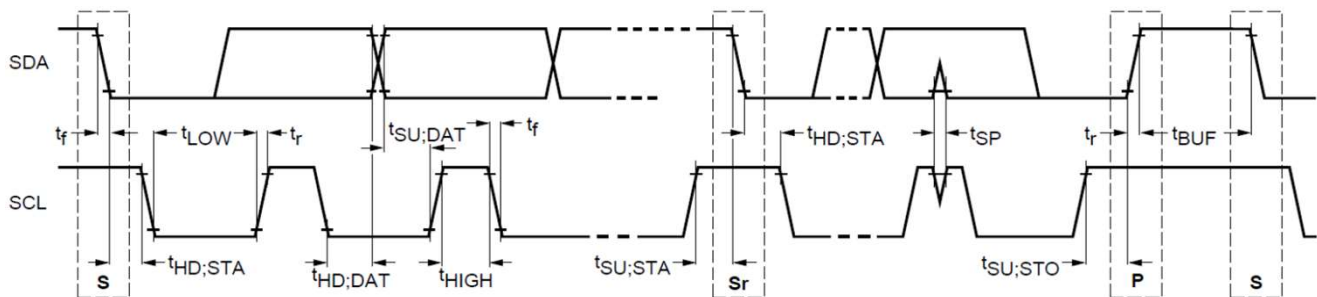

Parameter	Symbol	Standard-Mode Specs		Actual Measured		Unit
		Min	Max			
SCL clock frequency	f_{SCL}	0	100	95		KHz
Hold time (repeated) START condition	$t_{HD;STA}$	4.0	-	4.6		uS
LOW period of SCL clock	t_{LOW}	4.7	-	4.7		uS
HIGH period of SCL clock	t_{HIGH}	4.0	-	4.2		uS
Setup time for repeated START condition	$t_{SU;STA}$	4.7	-	4.7		uS
Data hold time	$t_{HD;DAT}$	0	3.45	0.5		uS
Data setup time	$t_{SU;DAT}$	250	-	4000		nS
Rise time	t_r	-	1000	SCL = 890	SDA = 915	nS
Fall time	t_f	-	300	SCL = 285	SDA = 590	nS
Setup time for STOP condition	$t_{SU;STO}$	4.0	-	5.8		uS
Bus free time between a STOP and START condition	t_{BUF}	4.7	-	69		uS

*** Note Philips™ I²C adapter and bundled software (USB-to-I²C) was used

COMMUNICATION BUS DESCRIPTIONS

Device Addressing

The LCM600 series will respond to supported commands on the I²C bus that are addressed according to pin A0 of output connector.

Address pin are held HIGH by default via pull up to internal 5V supply with a 2K ohm resistor and voltage limited to 2.7V with zener diodes. To set the address as “0”, the corresponding address line should be pulled down to logic ground level. Below tables show the address of the power supply with A0 pins set to either “0” or “1”.

PSU Slot	Slot ID Bits	PMBus™ Address
	A0	
1	0	B0
2	1	B2

* Default PMBus™ address is B2.

COMMUNICATION BUS DESCRIPTIONS

I²C Synchronization

The LCM600 series power supply might apply clock stretching. An addressed slave power supply may hold the clock line (SCL) low after receiving (or sending) a byte, indicating that it is not yet ready to process more data. The system master that is communicating with the power supply will attempt to raise the clock to transfer the next bit, but must verify that the clock line was actually raised. If the power supply is clock stretching, the clock line will still be low (because the connections are open-drain).

The maximum time out condition for clock stretching for LCM600 series is 100 milliseconds.

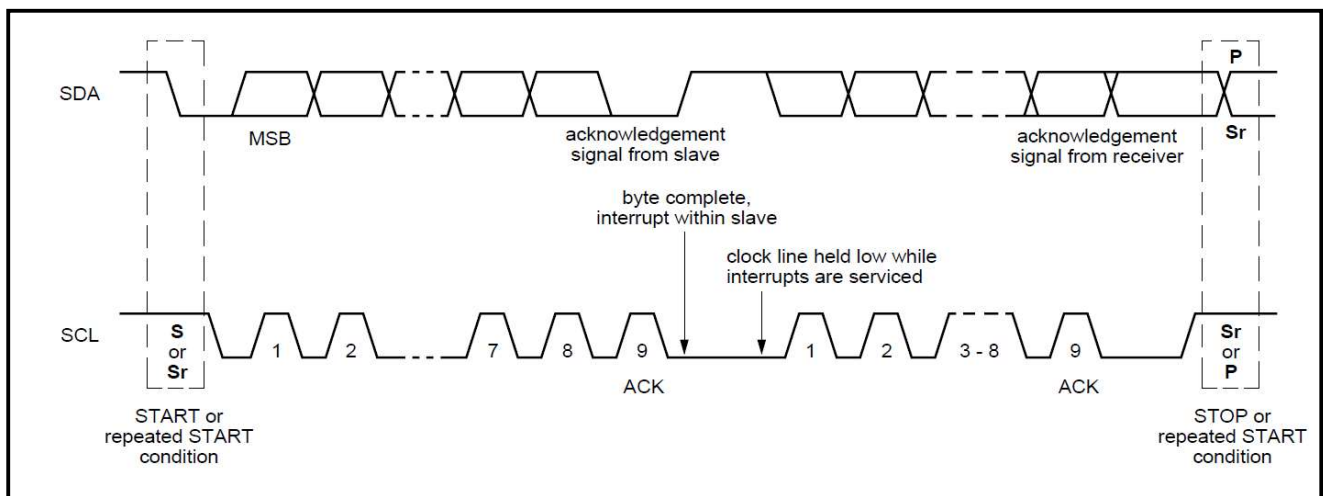

PMBus™ SPECIFICATIONS

The LCM600 series is compliant with the industry standard PMBus™ protocol for monitoring and control of the power supply via the I²C interface port.

LCM600 Series PMBus™ General Instructions

Equipment Setup

The following is typical I²C communication setup:

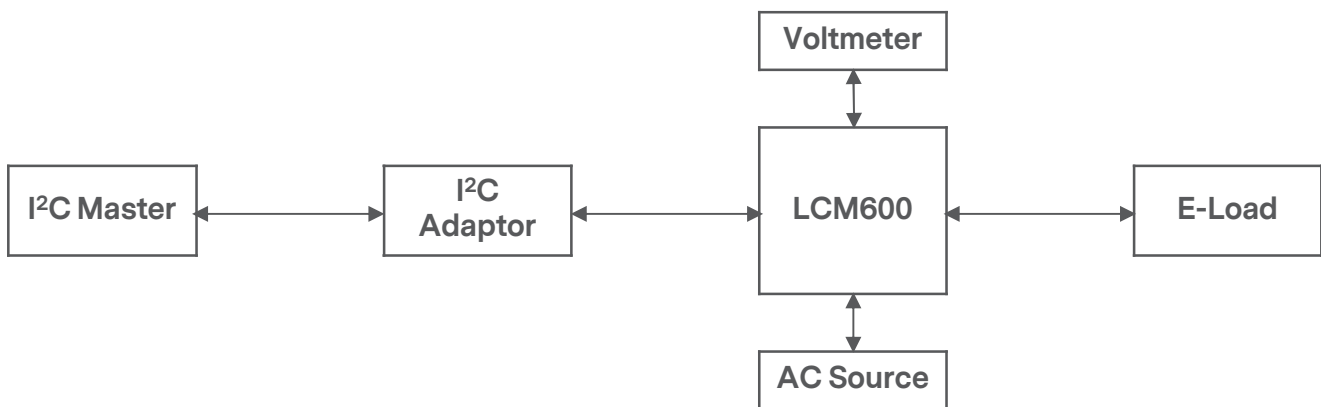

PMBus™ Writing Instructions

When writing to any PMBus™ R/W registers, ALWAYS do the following:

Disable Write Protect (command 10h) by writing any of the following accordingly:

Levels: 00h - Enable writing to all writeable commands

20h - Disables write except 10h, 01h, 00h, 02h and 21h commands

40h - Disables write except 10h, 01h, and 00h commands

80h - Disable write except 0x00h

To save changes on the USER PMBus™ Table:

Use send byte command: 15h STORE_USER_ALL

Wait for 5 seconds, turn-off the PSU, wait for another 5 seconds before turning it on.

PMBus™ SPECIFICATIONS

The LCM600L Supported PMBus™ Command List (the default value shown in below table is for LCM600L model only):

Command Code	Command Name	Default Value	Access Type	Data Bytes	Data Format	Description
03h	CLEAR_FAULTS	-	S	1		
10h	WRITE_PROTECT	00	R/W	1	MSF	Used to Control Writing to the PMBus Device 80h - Disables write except 10h 40h - Disables write except 10h, 01h, 00h 20h - Disables write except 10h, 01h,00h,02h and 21h commands 00h - Enables write to all writeable commands.
15h	STORE_USER_ALL	-	S	0		Copies the operating memory table to the matching USER non-volatile memory.
20h	VOUT_MODE	17	R	1	Linear	Specifies the mode and parameters of output voltage related data formats.
21h	VOUT_COMMAND	1800	R	2	Linear	Output voltage reference (12V)
24h	VOUT_MAX		R	2	Linear	Sets the max adjustable output voltage limit. (14.688V)
31h	POUT_MAX		R	2	Linear	Sets the operating power limit condition. (600W)
40h	VOUT_OV_FAULT_LIMIT		R/W	2	Linear	Sets output over voltage threshold. (15V)
41h	VOUT_OV_FAULT_RESPONSE	C0	R	1	MSF	Unit latches OFF. Resets on PSON or CONTROL pin recycle or AC recycle.
42h	VOUT_OV_WARN_LIMIT		R	2	Linear	Sets over-voltage warning threshold. (14.699V)
43h	VOUT_UV_WARN_LIMIT		R	2	Linear	Sets under-voltage warning threshold. (7.949V)
44h	VOUT_UV_FAULT_LIMIT		R	2	Linear	Sets under-voltage fault threshold. (7.559V)
45h	VOUT_UV_FAULT_RESPONSE	C0	R	1	MSF	Turn PSU OFF
46h	IOUT_OC_FAULT_LIMIT		R	2	Linear	Sets the over current threshold in Amps. (55A)
47h	IOUT_OC_FAULT_RESPONSE	C0	R	1	MSF	OCF ride through if OCF persists.
4Ah	IOUT_OC_WARN_LIMIT		R	2	Linear	Sets the over current warning threshold in Amps. (54.5A)
4Fh	OT_FAULT_LIMIT		R	2	Linear	Secondary ambient temperature Fault threshold, in degree C. (130degC)
50h	OT_FAULT_RESPONSE	C0	R	1	MSF	Turn PSU OFF and will retry indefinitely
51h	OT_WARN_LIMIT		R	2	Linear	Secondary ambient temperature warning threshold, in degree C. Operating limit. (125 degC)
5Eh	POWER_GOOD_ON		R	2	Linear	Sets the threshold by which the Power Good signal is asserted. (8.209V)

PMBus™ SPECIFICATIONS

The LCM600L Supported PMBus™ Command List:

Command Code	Command Name	Default Value	Access Type	Data Bytes	Data Format	Description
5Fh	POWER_GOOD_OFF		R	2	Linear	Sets the threshold by which the Power good signal is de-asserted. (7.209V)
60h	TON_DELAY		R	2	Linear	Sets the time (sec), from start condition (Power ON) until the output starts to rise. (1600ms)
61h	TON_RISE		R	2	Linear	Sets the time (ms), for the output rises from 0 to regulation. (200ms)
64h	TOFF_DELAY		R	2	Linear	Sets the time (ms), from a stop condition (Power OFF) until the output starts to drop (converter OFF). (20ms)
78h	STATUS_BYTE	00	R	1	Binary	Returns the summary of critical faults.
	b7 - BUSY					Not support
	b6 - OFF					Unit is OFF.
	b5 - VOUT_OV					Output over voltage fault has occurred.
	b4 - IOUT_OC					Output over current fault has occurred.
	b3 - VIN_UV					Not support.
	b2 - TEMPERATURE					A temperature fault or warning has occurred.
	b1 - CML					Not support
	b0 - NONE OF THE ABOVE					Not support
79h	STATUS_WORD	0000	R	2	Binary	Summary of units fault and warning status.
	b15 - VOUT					An output voltage fault or warning has occurred.
	b14 - IOUT/POUT					An output current or power fault or warning has occurred.
	b13 - INPUT					An input voltage, current or power fault or warning as occurred.
	b12 - MFR					A manufacturer specific fault or warning has occurred.
	b11 - POWER_GOOD#					The POWER_GOOD signal is de-asserted
	b10 - FANS					Not support.
	b9 - OTHER					Not support.
	b8 - UNKNOWN					Not support
	b7 - BUSY					Not support
	b6 - OFF					Unit is OFF.

PMBus™ SPECIFICATIONS

The LCM600L Supported PMBus™ Command List:

Command Code	Command Name	Default Value	Access Type	Data Bytes	Data Format	Description
79h	b5 - VOUT_OV					Output over-voltage fault has occurred.
	b4 - IOUT_OC					Output over-current fault has occurred.
	b3 - VIN_UV					Not support
	b2 - TEMPERATURE					A temperature fault or warning has occurred.
	b1 - CML					Not support
	b0 - NONE_OF_THE_ABOVE					Not support.
7Ah	STATUS_VOUT	00	R	1	Binary	Output voltage related faults and warnings
	b7					VOUT over-voltage fault
	b6					VOUT over-voltage warning
	b5					VOUT under-voltage warning
	b4					VOUT under-voltage fault
	b3					Not support
	b2					TON_MAX fault
	b1					Not support
b0					Not support	
7Bh	STATUS_IOUT	00	R	1	Binary	Output current related faults and warnings
	b7					IOUT over current fault
	b6					Not support
	b5					IOUT over current warning
	b4					Not support
	b3					Not support
	b2					Not support
	b1					Not support
b0					Not support	
7Dh	STATUS_TEMPERATURE	00	R	1	Binary	Temperature related faults and warnings
	b7					Over-temperature fault
	b6					Over-temperature warning
	b5					Not support
	b4					Not support
b3:0					reserved	
8Bh	READ_VOUT	-	R	2	Linear	Returns the actual, measured voltage in Volts.
8Ch	READ_IOUT	-	R	2	Linear	Returns the output current in amperes.

PMBus™ SPECIFICATIONS

The LCM600L Supported PMBus™ Command List:

Command Code	Command Name	Default Value	Access Type	Data Bytes	Data Format	Description
8Dh	READ_TEMPERATURE_1	-	R	2	Linear	
96h	READ_POUT	-	R	2	Linear	Returns the output power, in Watts.
99h	MFR_ID		R/W	7	ASCII	
9Ah	MFR_MODEL	4C,43,4D,36,30,30,4C	R/W	7	ASCII	LCM600L
9Bh	MFR_REVISION	41,45	R/W	2	ASCII	
9Ch	MFR_LOCATION	4C,41,47,55,4E,41	R/W	6	ASCII	Laguna
9Eh	MFR_DATE		R/W	13	ASCII	13 CHAR
A0h	MFR_VIN_MIN		R	2	Linear	Minimum input voltage (100Vac)
A1h	MFR_VIN_MAX		R	2	Linear	Maximum input voltage (240Vac)
A2h	MFR_IIN_MAX		R	2	Linear	Maximum input current (8.5A)
A4h	MFR_VOUT_MIN		R	2	Linear	Minimum output voltage regulation window (9.408V)
A5h	MFR_VOUT_MAX		R	2	Linear	Maximum output voltage. regulation window (14.688V)
A6h	MFR_IOUT_MAX		R	2	Linear	Maximum output current (52A)
A7h	MFR_POUT_MAX		R	2	Linear	Maximum output power (600W)
A8h	MFR_TAMBIENT_MAX		R	2	Linear	Maximum operating ambient temperature (Secondary Ambient) (70 degC)
A9h	MFR_TAMBIENT_MIN		R	2	Linear	Minimum operating ambient temperature (Secondary Ambient) (-40 degC)
D5h	Code revision		R	8	ASCII	

PMBus™ SPECIFICATIONS

The LCM600N Supported PMBus™ Command List (the default value shown in below table is for LCM600N model only):

Command Code	Command Name	Default Value	Access Type	Data Bytes	Data Format	Description
03h	CLEAR_FAULTS	-	S	1		
10h	WRITE_PROTECT	00	R/W	1	MSF	Used to control writing to the PMBus device 80h - Disables write except 10h 40h - Disables write except 10h, 01h, 00h 20h - Disables write except 10h, 01h, 00h, 02h and 21h commands 00h - Enables write to all writeable commands
15h	STORE_USER_ALL	-	S	0		Copies the operating memory table to the matching USER non-volatile memory.
20h	VOUT_MODE	17	R	1	Linear	Specifies the mode and parameters of output voltage related data formats
21h	VOUT_COMMAND	1E00	R	2	Linear	Output voltage reference (15V)
24h	VOUT_MAX		R	2	Linear	Sets the max adjustable output voltage limit. (19.889V)
31h	POUT_MAX		R	2	Linear	Sets the operating power limit condition. (600W)
40h	VOUT_OV_FAULT_LIMIT		R/W	2	Linear	Sets output over voltage threshold. (21.2V)
41h	VOUT_OV_FAULT_RESPONSE	C0	R	1	MSF	Unit latches OFF. Resets on PSON or CONTROL pin recycle or AC recycle.
42h	VOUT_OV_WARN_LIMIT		R	2	Linear	Sets over-voltage warning threshold. (20.199V)
43h	VOUT_UV_WARN_LIMIT		R	2	Linear	Sets under-voltage warning threshold. (13.818V)
44h	VOUT_UV_FAULT_LIMIT		R	2	Linear	Sets under-voltage fault threshold. (13.148V)
45h	VOUT_UV_FAULT_RESPONSE	C0	R	1	MSF	Turn PSU OFF
46h	IOUT_OC_FAULT_LIMIT		R	2	Linear	Sets the over current threshold in Amps. (44.875A)
47h	IOUT_OC_FAULT_RESPONSE	C0	R	1	MSF	OCP ride through if OCP persists.
4Ah	IOUT_OC_WARN_LIMIT		R	2	Linear	Sets the over current warning threshold in Amps. (44.375A)
4Fh	OT_FAULT_LIMIT		R	2	Linear	Secondary ambient temperature fault threshold, in degree C. (130degC)
50h	OT_FAULT_RESPONSE	C0	R	1	MSF	Turn PSU OFF and will retry indefinitely
51h	OT_WARN_LIMIT		R	2	Linear	Secondary ambient temperature warning threshold, in degree C. Operating limit. (125degC)
5Eh	POWER_GOOD_ON		R	2	Linear	Sets the threshold by which the Power Good signal is asserted. (14.27V)

PMBus™ SPECIFICATIONS

The LCM600N Supported PMBus™ Command List:

Command Code	Command Name	Default Value	Access Type	Data Bytes	Data Format	Description
5Fh	POWER_GOOD_OFF		R	2	Linear	Sets the threshold by which the Power Good signal is de-asserted. (13.27V)
60h	TON_DELAY		R	2	Linear	Sets the time (sec), from start condition (Power ON) until the output starts to rise. (1600ms)
61h	TON_RISE		R	2	Linear	Sets the time (ms), for the output rises from 0 to regulation. (200ms)
64h	TOFF_DELAY		R	2	Linear	Sets the time (ms), from a stop condition (Power OFF) until the output starts to drop (converter OFF). (20ms)
78h	STATUS_BYTE	00	R	1	Binary	Returns the summary of critical faults.
	b7 - BUSY					Not support
	b6 - OFF					Unit is OFF.
	b5 - VOUT_OV					Output over voltage fault has occurred.
	b4 - IOUT_OC					Output over current fault has occurred.
	b3 - VIN_UV					Not support.
	b2 - TEMPERATURE					A temperature fault or warning has occurred.
	b1 - CML					Not support
b0 - NONE OF THE ABOVE					Not support	
79h	STATUS_WORD	0000	R	2	Binary	Summary of units fault and warning status.
	b15 - VOUT					An output voltage fault or warning has occurred.
	b14 - IOUT/POUT					An output current or power fault or warning has occurred.
	b13 - INPUT					An input voltage, current or power fault or warning as occurred.
	b12 - MFR					A manufacturer specific fault or warning has occurred.
	b11 - POWER_GOOD#					The POWER_GOOD signal is de-asserted
	b10 - FANS					Not support.
	b9 - OTHER					Not support.
	b8 - UNKNOWN					Not support
	b7 - BUSY					Not support
b6 - OFF					Unit is OFF.	

PMBus™ SPECIFICATIONS

The LCM600N Supported PMBus™ Command List:

Command Code	Command Name	Default Value	Access Type	Data Bytes	Data Format	Description
79h	b5 - VOUT_OV					Output over-voltage fault has occurred.
	b4 - IOUT_OC					Output over-current fault has occurred.
	b3 - VIN_UV					Not support
	b2 - TEMPERATURE					A temperature fault or warning has occurred.
	b1 - CML					Not support
	b0 - NONE_OF_THE_ABOVE					Not support.
7Ah	STATUS_VOUT	00	R	1	Binary	Output voltage related faults and warnings
	b7					VOUT over-voltage fault
	b6					VOUT over-voltage warning
	b5					VOUT under-voltage warning
	b4					VOUT under-voltage fault
	b3					Not support
	b2					TON_MAX fault
	b1					Not support
b0					Not support	
7Bh	STATUS_IOUT	00	R	1	Binary	Output current related faults and warnings
	b7					IOUT over current fault
	b6					Not support
	b5					IOUT over current warning
	b4					Not support
	b3					Not support
	b2					Not support
	b1					Not support
b0					Not support	
7Dh	STATUS_TEMPERATURE	00	R	1	Binary	Temperature related faults and warnings
	b7					Over-temperature fault
	b6					Over-temperature warning
	b5					Not support
	b4					Not support
b3:0					reserved	
81h	STATUS_FANS_1_2	00	R	1	Binary	
8Bh	READ_VOUT	-	R	2	Linear	Returns the actual, measured voltage in Volts.

PMBus™ SPECIFICATIONS

The LCM600N Supported PMBus™ Command List:

Command Code	Command Name	Default Value	Access Type	Data Bytes	Data Format	Description
8Ch	READ_IOUT	-	R	2	Linear	Returns the output current in amperes.
8Dh	READ_TEMPERATURE_1	-	R	2	Linear	
96h	READ_POUT	-	R	2	Linear	Returns the output power, in Watts.
99h	MFR_ID		R/W	7	ASCII	
9Ah	MFR_MODEL	4C,43,4D,36,30,30,4E	R/W	7	ASCII	LCM600N
9Bh	MFR_REVISION	41,43	R/W	2	ASCII	
9Ch	MFR_LOCATION	4C,41,47,55,4E,41	R/W	6	ASCII	Laguna
9Eh	MFR_DATE		R/W	13	ASCII	13 CHAR
A0h	MFR_VIN_MIN		R	2	Linear	Minimum input voltage (100Vac)
A1h	MFR_VIN_MAX		R	2	Linear	Maximum input voltage (240Vac)
A2h	MFR_IIN_MAX		R	2	Linear	Maximum input current (8.5A)
A4h	MFR_VOUT_MIN		R	2	Linear	Minimum output voltage regulation window. (11.76V)
A5h	MFR_VOUT_MAX		R	2	Linear	Maximum output voltage. regulation window (19.889V)
A6h	MFR_IOUT_MAX		R	2	Linear	Maximum output current (44A)
A7h	MFR_POUT_MAX		R	2	Linear	Maximum output power(600W)
A8h	MFR_TAMBIENT_MAX		R	2	Linear	Maximum operating ambient temperature (Secondary ambient) (70degC)
A9h	MFR_TAMBIENT_MIN		R	2	Linear	Minimum operating ambient temperature (Secondary ambient) (-40degC)
D5h	Code revision		R	8	ASCII	

PMBus™ SPECIFICATIONS

The LCM600Q Supported PMBus™ Command List (the default value shown in below table is for LCM600Q model only) :

Command Code	Command Name	Default Value	Access Type	Data Bytes	Data Format	Description
03h	CLEAR_FAULTS	-	S	1		
10h	WRITE_PROTECT	80	R/W	1	MSF	Used to control writing to the pmbus device 80h - Disables write except 10h 40h - Disables write except 10h, 01h, 00h 20h - Disables write except 10h, 01h,00h,02h and 21h commands 00h - Enables write to all writeable commands.
15h	STORE_USER_ALL	-	S	0		Copies the operating memory table to the matching USER non-volatile memory.
20h	VOUT_MODE	17	R	1	Linear	Specifies the mode and parameters of output voltage related data formats.
21h	VOUT_COMMAND	3000	R	2	Linear	Output voltage reference (24V)
24h	VOUT_MAX	30F6	R	2	Linear	Sets the max adjustable output voltage limit. (24.48V)
31h	POUT_MAX	0258	R	2	Linear	Sets the operating power limit condition. (600W)
40h	VOUT_OV_FAULT_LIMIT	3E00	R/W	2	Linear	Sets output over voltage threshold. (31V)
41h	VOUT_OV_FAULT_RESPONSE	C0	R	1	MSF	Unit latches OFF. Resets on PSON or CONTROL pin recycle or AC recycle.
42h	VOUT_OV_WARN_LIMIT	3C00	R	2	Linear	Sets over-voltage warning threshold. (30V)
43h	VOUT_UV_WARN_LIMIT	2400	R	2	Linear	Sets under-voltage warning threshold. (18V)
44h	VOUT_UV_FAULT_LIMIT	1E00	R	2	Linear	Sets under-voltage fault threshold. (15V)
45h	VOUT_UV_FAULT_RESPONSE	C0	R	1	MSF	Turn PSU OFF
46h	IOUT_OC_FAULT_LIMIT	DB80	R	2	Linear	Sets the over current threshold in Amps. (28A)
47h	IOUT_OC_FAULT_RESPONSE	C0	R	1	MSF	OCF ride through if OCF persists.
4Ah	IOUT_OC_WARN_LIMIT	DB50	R	2	Linear	Sets the over current warning threshold in Amps. (26.5A)
4Fh	OT_FAULT_LIMIT	EB98	R	2	Linear	Secondary ambient temperature fault threshold, in degree C. (115degC)
50h	OT_FAULT_RESPONSE	C0	R	1	MSF	Turn PSU OFF and will retry indefinitely
51h	OT_WARN_LIMIT	EB70	R	2	Linear	Secondary ambient temperature warning threshold, in degree C. Operating limit. (110degC)
5Eh	POWER_GOOD_ON	2600	R	2	Linear	Sets the threshold by which the Power Good signal is asserted. (19V)

PMBus™ SPECIFICATIONS

The LCM600Q Supported PMBus™ Command List:

Command Code	Command Name	Default Value	Access Type	Data Bytes	Data Format	Description
5Fh	POWER_GOOD_OFF	2400	R	2	Linear	Sets the threshold by which the Power Good signal is de-asserted. (18V)
60h	TON_DELAY	BB33	R	2	Linear	Sets the time (sec), from start condition (Power ON) until the output starts to rise. (1600ms)
61h	TON_RISE	9A66	R	2	Linear	Sets the time (ms), for the output rises from 0 to regulation. (200ms)
64h	TOFF_DELAY	8A8F	R	2	Linear	Sets the time (ms), from a stop condition (Power OFF) until the output starts to drop (converter OFF). (20ms)
78h	STATUS_BYTE	00	R	1	Binary	Returns the summary of critical faults.
	b7 - BUSY					Not support
	b6 - OFF					Unit is OFF.
	b5 - VOUT_OV					Output over voltage fault has occurred.
	b4 - IOOUT_OC					Output over current fault has occurred.
	b3 - VIN_UV					Not support.
	b2 - TEMPERATURE					A temperature fault or warning has occurred.
	b1 - CML					Not support
79h	b0 - NONE OF THE ABOVE					Not support
	STATUS_WORD	0000	R	2	Binary	Summary of units fault and warning status.
	b15 - VOUT					An output voltage fault or warning has occurred.
	b14 - IOOUT/POUT					An output current or power fault or warning has occurred.
	b13 - INPUT					An input voltage, current or power fault or warning as occurred.
	b12 - MFR					A manufacturer specific fault or warning has occurred.
	b11 - POWER_GOOD#					The POWER_GOOD signal is de-asserted
	b10 - FANS					Not support.
	b9 - OTHER					Not support.
	b8 - UNKNOWN					Not support
	b7 - BUSY					Not support
b6 - OFF					Unit is OFF.	

PMBus™ SPECIFICATIONS

The LCM600Q Supported PMBus™ Command List:

Command Code	Command Name	Default Value	Access Type	Data Bytes	Data Format	Description
79h	b5 - VOUT_OV					Output over-voltage fault has occurred.
	b4 - IOOUT_OC					Output over-current fault has occurred.
	b3 - VIN_UV					Not support
	b2 - TEMPERATURE					A temperature fault or warning has occurred.
	b1 - CML					Not support
	b0 - NONE_OF_THE_ABOVE					Not support.
7Ah	STATUS_VOUT	00	R	1	Binary	Output voltage related faults and warnings
	b7					VOUT over-voltage fault
	b6					VOUT over-voltage warning
	b5					VOUT under-voltage warning
	b4					VOUT under-voltage fault
	b3					Not support
	b2					TON_MAX fault
	b1					Not support
	b0					Not support
7Bh	STATUS_IOOUT	00	R	1	Binary	Output current related faults and warnings
	b7					IOOUT over current fault
	b6					Not support
	b5					IOOUT over current warning
	b4					Not support
	b3					Not support
	b2					Not support
	b1					Not support
	b0					Not support
7Dh	STATUS_TEMPERATURE	00	R	1	Binary	Temperature related faults and warnings
	b7					Over-temperature fault
	b6					Over-temperature warning
	b5					Not support
	b4					Not support
	b3:0					reserved
8Bh	READ_VOUT	-	R	2	Linear	Returns the actual, measured voltage in Volts.

PMBus™ SPECIFICATIONS

The LCM600Q Supported PMBus™ Command List:

Command Code	Command Name	Default Value	Access Type	Data Bytes	Data Format	Description
8Ch	READ_IOUT	-	R	2	Linear	Returns the output current in amperes.
8Dh	READ_TEMPERATURE_2	-	R	2	Linear	
96h	READ_POUT	-	R	2	Linear	Returns the output power, in Watts.
99h	MFR_ID		R/W	7	ASCII	
9Ah	MFR_MODEL	07,4C,43,4D,36,30,30,51	R/W	7	ASCII	LCM600Q
9Bh	MFR_REVISION	02,20,20	R/W	2	ASCII	
9Ch	MFR_LOCATION	06,4C,61,67,75,6E,61	R/W	6	ASCII	Laguna
9Eh	MFR_DATE		R/W	13	ASCII	13 CHAR
A0h	MFR_VIN_MIN	EB20	R	2	Linear	Minimum input voltage (100Vac)
A1h	MFR_VIN_MAX	F3C0	R	2	Linear	Maximum input voltage (240Vac)
A2h	MFR_IIN_MAX	D220	R	2	Linear	Maximum input current (8.5A)
A4h	MFR_VOUT_MIN	2F0A	R	2	Linear	Minimum output voltage regulation window (23.52V)
A5h	MFR_VOUT_MAX	30F6	R	2	Linear	Maximum output voltage regulation window (24.48V)
A6h	MFR_IOUT_MAX	DB20	R	2	Linear	Maximum output current (25A)
A7h	MFR_POUT_MAX	0258	R	2	Linear	Maximum output power (600W)
A8h	MFR_TAMBIENT_MAX	EA30	R	2	Linear	Maximum operating ambient temperature (Secondary ambient) (70degC)
A9h	MFR_TAMBIENT_MIN	E580	R	2	Linear	Minimum operating ambient temperature (Secondary ambient) (-40degC)
D5h	Code revision		R	8	ASCII	

PMBus™ SPECIFICATIONS

The LCM600U Supported PMBus™ Command List : (the default value shown in below table is for LCM600U model only):

Command Code	Command Name	Default Value	Access Type	Data Bytes	Data Format	Description
03h	CLEAR_FAULTS	-	S	1		
10h	WRITE_PROTECT	00	R/W	1	MSF	Used to control writing to the pmbus device 80h - Disables write except 10h 40h - Disables write except 10h, 01h, 00h 20h - Disables write except 10h, 01h,00h,02h and 21h commands 00h - Enables write to all writeable commands.
15h	STORE_USER_ALL	-	S	0		Copies the operating memory table to the matching USER non-volatile memory.
20h	VOUT_MODE	17	R	1	Linear	Specifies the mode and parameters of output voltage related data formats.
21h	VOUT_COMMAND	4800	R	2	Linear	Output voltage reference (36V)
24h	VOUT_MAX		R	2	Linear	Sets the max adjustable output voltage limit. (43.2V)
31h	POUT_MAX		R	2	Linear	Sets the operating power limit condition. (600W)
40h	VOUT_OV_FAULT_LIMIT		R/W	2	Linear	Sets output over voltage threshold. (49V)
41h	VOUT_OV_FAULT_RESPONSE	C0	R	1	MSF	Unit latches OFF. Resets on PSON or CONTROL pin recycle or AC recycle.
42h	VOUT_OV_WARN_LIMIT		R	2	Linear	Sets over-voltage warning threshold. (44.059V)
43h	VOUT_UV_WARN_LIMIT		R	2	Linear	Sets under-voltage warning threshold. (33.318V)
44h	VOUT_UV_FAULT_LIMIT		R	2	Linear	Sets under-voltage fault threshold. (31.689V)
45h	VOUT_UV_FAULT_RESPONSE	C0	R	1	MSF	Turn PSU OFF
46h	IOUT_OC_FAULT_LIMIT		R	2	Linear	Sets the over current threshold in Amps. (19A)
47h	IOUT_OC_FAULT_RESPONSE	C0	R	1	MSF	OCP ride through. If OCP persists.
4Ah	IOUT_OC_WARN_LIMIT		R	2	Linear	Sets the over current warning threshold in Amps. (18.5A)
4Fh	OT_FAULT_LIMIT		R	2	Linear	Secondary ambient temperature fault threshold, in degree C. (125degC)
50h	OT_FAULT_RESPONSE	C0	R	1	MSF	Turn PSU OFF and will retry indefinitely.
51h	OT_WARN_LIMIT		R	2	Linear	Secondary ambient temperature warning threshold, in degree C. Operating limit. (110degC)
5Eh	POWER_GOOD_ON		R	2	Linear	Sets the threshold by which the Power Good signal is asserted. (34.398V)

PMBus™ SPECIFICATIONS

The LCM600U Supported PMBus™ Command List:

Command Code	Command Name	Default Value	Access Type	Data Bytes	Data Format	Description
5Fh	POWER_GOOD_OFF		R	2	Linear	Sets the threshold by which the Power Good signal is de-asserted. (33.398V)
60h	TON_DELAY		R	2	Linear	Sets the time (sec), from start condition (Power ON) until the output starts to rise. (1600ms)
61h	TON_RISE		R	2	Linear	Sets the time (ms), for the output rises from 0 to regulation. (200ms)
64h	TOFF_DELAY		R	2	Linear	Sets the time (ms), from a stop condition (Power OFF) until the output starts to drop (converter OFF). (20ms)
78h	STATUS_BYTE	00	R	1	Binary	Returns the summary of critical faults.
	b7 - BUSY					Not support
	b6 - OFF					Unit is OFF.
	b5 - VOUT_OV					Output over voltage fault has occurred.
	b4 - IOOUT_OC					Output over current fault has occurred.
	b3 - VIN_UV					Not support.
	b2 - TEMPERATURE					A temperature fault or warning has occurred.
	b1 - CML					Not support
79h	b0 - NONE OF THE ABOVE					Not support
	STATUS_WORD	0000	R	2	Binary	Summary of units fault and warning status.
	b15 - VOUT					An output voltage fault or warning has occurred.
	b14 - IOOUT/POUT					An output current or power fault or warning has occurred.
	b13 - INPUT					An input voltage, current or power fault or warning as occurred.
	b12 - MFR					A manufacturer specific fault or warning has occurred.
	b11 - POWER_GOOD#					The POWER_GOOD signal is de-asserted
	b10 - FANS					Not support.
	b9 - OTHER					Not support.
	b8 - UNKNOWN					Not support
	b7 - BUSY					Not support
b6 - OFF					Unit is OFF.	

PMBus™ SPECIFICATIONS

The LCM600U Supported PMBus™ Command List:

Command Code	Command Name	Default Value	Access Type	Data Bytes	Data Format	Description
79h	b5 - VOUT_OV					Output over-voltage fault has occurred.
	b4 - IOOUT_OC					Output over-current fault has occurred.
	b3 - VIN_UV					Not support
	b2 - TEMPERATURE					A temperature fault or warning has occurred.
	b1 - CML					Not support
	b0 - NONE_OF_THE_ABOVE					Not support.
7Ah	STATUS_VOUT	00	R	1	Binary	Output voltage related faults and warnings
	b7					VOUT over-voltage fault
	b6					VOUT over-voltage warning
	b5					VOUT under-voltage warning
	b4					VOUT under-voltage fault
	b3					Not support
	b2					TON_MAX fault
	b1					Not support
b0					Not support	
7Bh	STATUS_IOOUT	00	R	1	Binary	Output current related faults and warnings
	b7					IOOUT over current fault
	b6					Not support
	b5					IOOUT over current warning
	b4					Not support
	b3					Not support
	b2					Not support
	b1					Not support
b0					Not support	
7Dh	STATUS_TEMPERATURE	00	R	1	Binary	Temperature related faults and warnings
	b7					Over-temperature fault
	b6					Over-temperature warning
	b5					Not support
	b4					Not support
	b3:0					reserved
8Bh	READ_VOUT	-	R	2	Linear	Returns the actual, measured voltage in Volts.

PMBus™ SPECIFICATIONS

The LCM600U Supported PMBus™ Command List:

Command Code	Command Name	Default Value	Access Type	Data Bytes	Data Format	Description
8Ch	READ_IOUT	-	R	2	Linear	Returns the output current in amperes.
8Dh	READ_TEMPERATURE_1	-	R	2	Linear	
96h	READ_POUT	-	R	2	Linear	Returns the output power, in Watts.
99h	MFR_ID		R/W	7	ASCII	
9Ah	MFR_MODEL	4C,43,4D,36,30,30,55	R/W	7	ASCII	LCM600U
9Bh	MFR_REVISION	41,41	R/W	2	ASCII	
9Ch	MFR_LOCATION	4C,41,47,55,4E,41	R/W	6	ASCII	Laguna
9Eh	MFR_DATE		R/W	13	ASCII	13 CHAR
A0h	MFR_VIN_MIN		R	2	Linear	Minimum input voltage (100Vac)
A1h	MFR_VIN_MAX		R	2	Linear	Maximum input voltage (240Vac)
A2h	MFR_IIN_MAX		R	2	Linear	Maximum input current (9A)
A4h	MFR_VOUT_MIN		R	2	Linear	Minimum output voltage regulation window (28.8V)
A5h	MFR_VOUT_MAX		R	2	Linear	Maximum output voltage. regulation window (43.2V)
A6h	MFR_IOUT_MAX		R	2	Linear	Maximum output current (18A)
A7h	MFR_POUT_MAX		R	2	Linear	Maximum output power (600W)
A8h	MFR_TAMBIENT_MAX		R	2	Linear	Maximum operating ambient temperature (Secondary ambient) (70degC)
A9h	MFR_TAMBIENT_MIN		R	2	Linear	Minimum operating ambient temperature (Secondary ambient) (-40degC)
D5h	Code revision		R	8	ASCII	

PMBus™ SPECIFICATIONS

The LCM600W Supported PMBus™ Command List (the default value shown in below table is for LCM600W model only):

Command Code	Command Name	Default Value	Access Type	Data Bytes	Data Format	Description
03h	CLEAR_FAULTS	-	S	1		
10h	WRITE_PROTECT	00	R/W	1	MSF	Used to control writing to the pmbus device 80h - Disables write except 10h 40h - Disables write except 10h, 01h, 00h 20h - Disables write except 10h, 01h,00h,02h and 21h commands 00h - Enables write to all writeable commands.
15h	STORE_USER_ALL	-	S	0		Copies the operating memory table to the matching USER non-volatile memory.
20h	VOUT_MODE	17	R	1	Linear	Specifies the mode and parameters of output voltage related data formats.
21h	VOUT_COMMAND	6000	R	2	Linear	Output voltage reference (48V)
24h	VOUT_MAX		R	2	Linear	Sets the max adjustable output voltage limit. (56V)
31h	POUT_MAX		R	2	Linear	Sets the operating power limit condition. (600W)
46h	IOUT_OC_FAULT_LIMIT		R	2	Linear	Sets the over current threshold in Amps. (13.797A)
47h	IOUT_OC_FAULT_RESPONSE	C0	R	1	MSF	OCP ride through. If OCP persists.
4Ah	IOUT_OC_WARN_LIMIT		R	2	Linear	Sets the over current warning threshold in Amps. (13.297A)
4Fh	OT_FAULT_LIMIT		R	2	Linear	Secondary ambient temperature fault threshold, in degree C. (115degC)
50h	OT_FAULT_RESPONSE	C0	R	1	MSF	Turn PSU OFF and will retry indefinitely.
51h	OT_WARN_LIMIT		R	2	Linear	Secondary ambient temperature warning threshold, in degree C. Operating limit. (110degC)
5Eh	POWER_GOOD_ON		R	2	Linear	Sets the threshold by which the Power Good signal is asserted. (41.828V)
5Fh	POWER_GOOD_OFF		R	2	Linear	Sets the threshold by which the Power Good signal is de-asserted. (40.828V)
60h	TON_DELAY		R	2	Linear	Sets the time (sec), from start condition (Power ON) until the output starts to rise. (1600ms)
61h	TON_RISE		R	2	Linear	Sets the time (ms), for the output rises from 0 to regulation. (200ms)
64h	TOFF_DELAY	8A8F	R	2	Linear	Sets the time (ms), from a stop condition (Power OFF) until the output starts to drop (converter OFF). (20ms)

PMBus™ SPECIFICATIONS

The LCM600W Supported PMBus™ Command List:

Command Code	Command Name	Default Value	Access Type	Data Bytes	Data Format	Description
78h	STATUS_BYTE	00	R	1	Binary	Returns the summary of critical faults.
	b7 - BUSY					Not support
	b6 - OFF					Unit is OFF.
	b5 - VOUT_OV					Output over voltage fault has occurred.
	b4 - IOUT_OC					Output over current fault has occurred.
	b3 - VIN_UV					Not support.
	b2 - TEMPERATURE					A temperature fault or warning has occurred.
	b1 - CML					Not support
	b0 - NONE OF THE ABOVE					Not support
79h	STATUS_WORD	0000	R	2	Binary	Summary of units fault and warning status.
	b15 - VOUT					An output voltage fault or warning has occurred.
	b14 - IOUT/POUT					An output current or power fault or warning has occurred.
	b13 - INPUT					An input voltage, current or power fault or warning as occurred.
	b12 - MFR					A manufacturer specific fault or warning has occurred.
	b11 - POWER_GOOD#					The POWER_GOOD signal is de-asserted
	b10 - FANS					Not support.
	b9 - OTHER					Not support.
	b8 - UNKNOWN					Not support
	b7 - BUSY					Not support
	b6 - OFF					Unit is OFF.
	b5 - VOUT_OV					Output over-voltage fault has occurred.
	b4 - IOUT_OC					Output over-current fault has occurred.
	b3 - VIN_UV					Not support
	b2 - TEMPERATURE					A temperature fault or warning has occurred.
	b1 - CML					Not support
	b0 - NONE_OF_THE_ABOVE					Not support.

PMBus™ SPECIFICATIONS

The LCM600W Supported PMBus™ Command List:

Command Code	Command Name	Default Value	Access Type	Data Bytes	Data Format	Description
7Ah	STATUS_VOUT	00	R	1	Binary	Output voltage related faults and warnings
	b7					VOUT over-voltage fault
	b6					VOUT over-voltage warning
	b5					VOUT under-voltage warning
	b4					VOUT under-voltage fault
	b3					Not support
	b2					TON_MAX fault
	b1					Not support
b0					Not support	
7Bh	STATUS_IOUT	00	R	1	Binary	Output current related faults and warnings
	b7					IOUT over current fault
	b6					Not support
	b5					IOUT over current warning
	b4					Not support
	b3					Not support
	b2					Not support
	b1					Not support
b0					Not support	
7Dh	STATUS_TEMPERATURE	00	R	1	Binary	Temperature related faults and warnings
	b7					Over-temperature fault
	b6					Over-temperature warning
	b5					Not support
	b4					Not support
b3:0					reserved	
81h	STATUS_FANS_1_2	00	R	1	Binary	
8Bh	READ_VOUT	-	R	2	Linear	Returns the actual, measured voltage in Volts.
8Ch	READ_IOUT	-	R	2	Linear	Returns the output current in amperes.
8Dh	READ_TEMPERATURE_2	-	R	2	Linear	
96h	READ_POUT	-	R	2	Linear	Returns the output power, in Watts.
99h	MFR_ID		R/W	7	ASCII	
9Ah	MFR_MODEL	4C,43,40,36,30,30,57	R/W	7	ASCII	LCM600W
9Bh	MFR_REVISION	30,30	R/W	2	ASCII	
9Ch	MFR_LOCATION	4C,41,47,55,4E,41	R/W	6	ASCII	Laguna

PMBus™ SPECIFICATIONS

The LCM600W Supported PMBus™ Command List:

Command Code	Command Name	Default Value	Access Type	Data Bytes	Data Format	Description
9Eh	MFR_DATE		R/W	13	ASCII	13 CHAR
A0h	MFR_VIN_MIN		R	2	Linear	Minimum input voltage (100Vac)
A1h	MFR_VIN_MAX		R	2	Linear	Maximum input voltage (240Vac)
A2h	MFR_IIN_MAX		R	2	Linear	Maximum input current (9A)
A4h	MFR_VOUT_MIN		R	2	Linear	Minimum output voltage regulation window (36V)
A5h	MFR_VOUT_MAX		R	2	Linear	Maximum output voltage. regulation window (56V)
A6h	MFR_IOOUT_MAX		R	2	Linear	Maximum output current (13A)
A7h	MFR_POOUT_MAX		R	2	Linear	Maximum output power (600W)
A8h	MFR_TAMBIENT_MAX		R	2	Linear	Maximum operating ambient temperature (Secondary ambient) (70degC)
A9h	MFR_TAMBIENT_MIN		R	2	Linear	Minimum operating ambient temperature (Secondary ambient) (-40degC)
D5h	Code revision		R	8	ASCII	

APPLICATION NOTES

Current Sharing

The LCM600 series main output V1 is equipped with current sharing capability. This will allow up to 10 power supplies to be connected in parallel for higher power application. Current share accuracy is typically 10% of full load. SWP Node voltage at full load is to be 5.5-6.5 Volts and 2.5-3.5 Volts at 50% of maximum current. The I²C Line should be connected separately when the number of units in parallel is more than 8.

The table below shows the derated maximum power capacity when units are in parallel configuration. This is to consider the 10% load sharing tolerance.

Number of Units in Parallel (N)	Maximum Output power Rated + [(N-1) x 0.9] x Rated, Where: Rated = 600W, N = Number of PSU in Parallel
Stand-alone 600W	600W
2	1140W
3	1680W
..	..
....
10	5460W

The PSU will have an active load sharing percentage as shown below.

Rail Loading	Ideal 100% share is 50%/50%	Example, (Total = 50A)
100%	10%: Max 55%, Min 45% of load	50A Total (27.5A to 22.5A)
50%	10%: Max 55%, Min 45% of load	25A Total (13.75A to 11.25A)
20%	20%: Max 60%, Min 40% of load	10A Total (6A to 4A)
Below 20%	Must not draw current or suffer functional problems.	Not Specified.

APPLICATION NOTES

Redundant Operation Connection Diagram

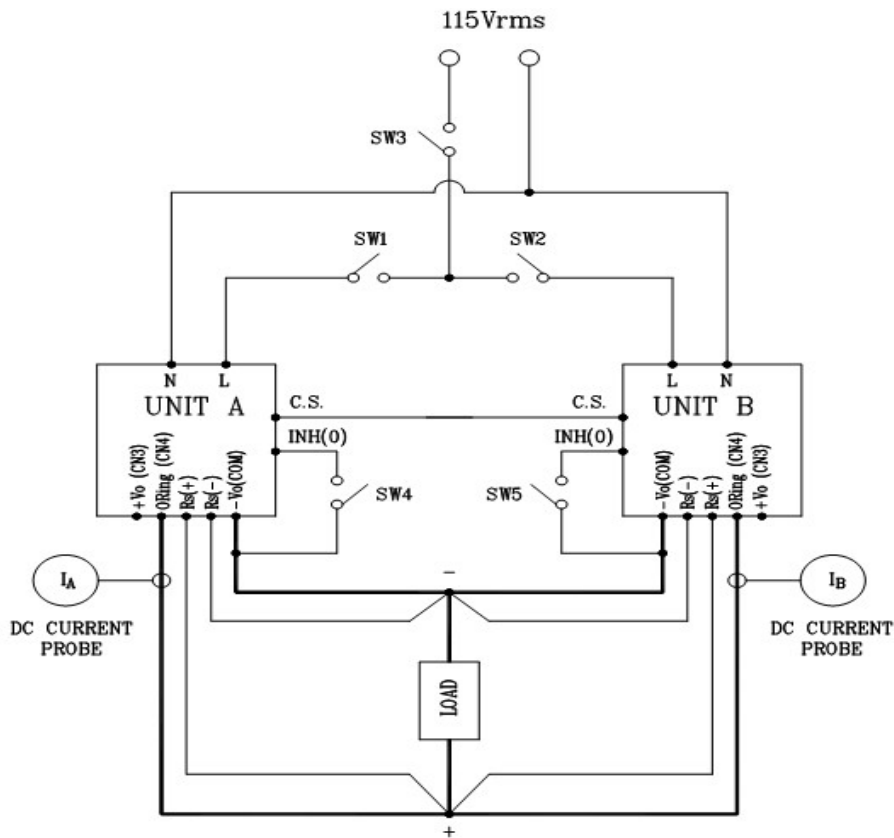

Note 1. Above figure shows connection for two power supply. Similar connection must below followed for higher number of power supplies connected. The maximum number of power supply is 8 power supply connection.

Note 2. PMBus address should be set unique per power supply.

Note 3. The G_DCOK_C pins and G_ACOK_C pins can be connected together to the system DCOK and ACOK input pins. This can also we wired separately so the system will still continue to operate in case 1 PSU fails. The system should have a 3 separate input for ACOK and DCOK signals.

Note 4. Read Iout per power supply. The reported I-out per power supply should be the same or similar.

APPLICATION NOTES

Output Ripple and Noise Measurement

The setup outlined in the diagram below has been used for output voltage ripple and noise measurements on the LCM600 series. When measuring output ripple and noise, a scope jack in parallel with a 0.1 μ F ceramic chip capacitor, and a 10 μ F aluminum electrolytic capacitor should be used. Oscilloscope should be set to 20MHz bandwidth for this measurement.

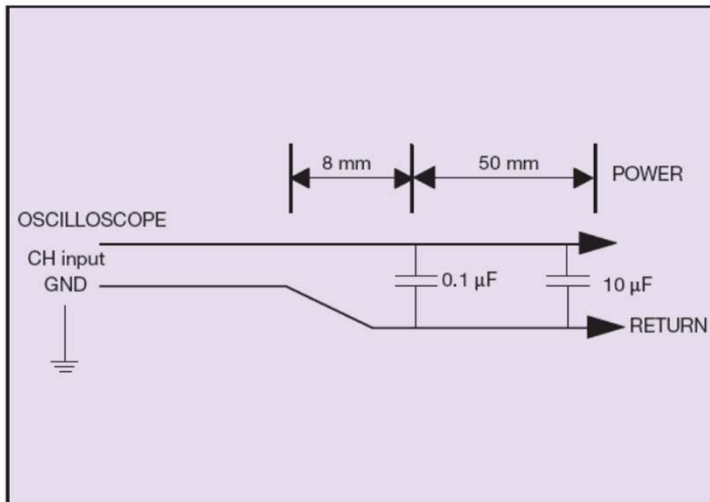

RECORD OF REVISION AND CHANGES

Issue	Date	Description	Originators
1.0	08.01.2012	First Issue	V. Wei
1.1	08.01.2012	Delete Global DCOK and ACOK signal SCH	V. Wei
1.2	11.07.2012	Add other product in the spec	V. Wei
1.3	09.06.2013	Update Global ACOK Circuit	V. Wei
1.4	11.04.2013	Update Command list 44h 46h WR	V. Wei
1.5	12.29.2014	Add the LCM600N	V. Wei
1.6	04.28.2015	Change the pull-up resistor of A0, A1, A2	V. Wei
1.7	01.13.2016	Updated the I ² C detail	V. Wei
1.8	05.03.2016	Update page 2 module number/ Update the remote sense description	K. Wang
1.9	06.03.2016	Update Terminal block and IEC connector	K. Wang
2.0	07.05.2016	Update IEC connector	K. Wang
2.1	11.08.2016	Update the waveform figure 34 to figure 39 for Power Good	K. Wang
2.2	01.26.2017	Delete the 90h command	K. Wang
2.3	09.12.2017	Update the operating altitude	A. Zhang
2.4	11.29.2017	Update the safety certificates	A. Zhang
2.5	03.26.2018	79H Fan fault warning is not support	K. Wang
2.6	05.05.2019	Update mating connectors / mechanical issue	K. Wang
2.7	10.25.2019	1. Add "-N" "-8" suffix note 2. OVP point	K. Wang
2.8	03.27.2020	1.Update the OCP description for L/N 2. Update dynamic 3. Add the isolation production spec	K. Wang
2.9	05.05.2020	Update leakage current specification	C. Liu
3.0	07.07.2020	1. Update Safety Certifications 2. Remove suffix "-8"	C. Yan/Kathy
3.1	06.22.2021	1. Add system timing specification and description on page 7 2. Add system timing diagram on page 8 3. Add ACOK/DCOK signal waveforms in performance curves	C. Liu
3.2	09.15.2021	Address A1/A2 not works. Only support B0 and B2 address.	K. Wang
3.3	11.11.2021	Update typo error from mF to uF	K. Wang
3.4	01.24.2022	Update UKCA and PMBus Logo	K. Wang
3.5	02.07.2022	Update timing diagram	J. Zhang
3.6	06.27.2022	Add 21h VOUT_COMMAND	C. Liu
3.7	03.25.2023	Add "-8" suffix option Update waveform description	E. Wang K. Wang
3.8	07.13.2023	Update 78h, 79h, 7Ah,7Bh,7Dh description Update LED picture	K. Wang



For international contact information,
visit advancedenergy.com.

powersales@aei.com (Sales Support)
productsupport.ep@aei.com (Technical Support)
+1 888 412 7832

ABOUT ADVANCED ENERGY

Advanced Energy (AE) has devoted more than three decades to perfecting power for its global customers. AE designs and manufactures highly engineered, precision power conversion, measurement and control solutions for mission-critical applications and processes.

Our products enable customer innovation in complex applications for a wide range of industries including semiconductor equipment, industrial, manufacturing, telecommunications, data center computing, and medical. With deep applications know-how and responsive service and support across the globe, we build collaborative partnerships to meet rapid technological developments, propel growth for our customers, and innovate the future of power.

PRECISION | POWER | PERFORMANCE | TRUST

Specifications are subject to change without notice. Not responsible for errors or omissions. ©2022 Advanced Energy Industries, Inc. All rights reserved. Advanced Energy®, and AE® are U.S. trademarks of Advanced Energy Industries, Inc.