

ARTESYN

ADO300-48S12 SERIES

300 Watts 1/8 Brick Converter



PRODUCT DESCRIPTION

Advanced Energy's Artesyn ADO300-48S12 series is a single output DC/DC converter with standard eighth-brick outline and pin configuration, as well as base plate and PMBus™ option. It delivers up to 26A output current with 11.7V output voltage. Above 95.2% ultra-high efficiency and excellent thermal performance makes it an ideal choice to supply power in telecom and Datacom. It can work under -40°C to +85°C with air cooling. PMBus™ option interface is also provided for a flexible digital control.

SPECIAL FEATURES

- Delivers up to 26A output current
- Ultra-high efficiency 95.2% typ. at full load
- Parallel with droop current sharing
- Startup Pre-bias
- Wide input range: 36V to 75V
- Fully regulated output voltage
- Excellent thermal performance
- Power Good (PG) feature
- No minimum load requirement
- RoHS 3.0
- Remote control function (negative logic; Secondary remote control function option)
- Input under voltage lockout
- Input over voltage lockout
- Output over current protection
- Output over voltage protection

- Over temperature protection

SAFETY

- TUV EN62368
- UL/TUV UL/EN60950
- UL94, V-0
- CE

TYPICAL APPLICATIONS

- Datacom
- Telecom

AT A GLANCE

Total Power

300 Watts

Input Voltage

36 to 75 Vac

of Outputs

Single



MODEL NUMBERS

Standard	Output Voltage	Structure	Pin Type	RoHS Status	PMBus™
ADO300-48S12-6L	11.82Vdc	Open-frame	Through hole	RoHS 3.0	No
ADO300-48S12B-6L	11.82Vdc	Baseplate	Through hole	RoHS 3.0	No
ADO300-48S12-6LI	11.82Vdc	Open-frame	Through hole	RoHS 3.0	Yes
ADO300-48S12B-6LI	11.82Vdc	Baseplate	Through hole	RoHS 3.0	Yes
ADO300-48S12B-4L	11.82Vdc	Baseplate	Through hole	RoHS 3.0	No

Order Information

ADO300	-	48	S	12	B	-	6	L	I
①		②	③	④	⑤		⑥	⑦	⑧

①	Model series	ADO: high efficiency digital control eighth brick series, 300: output power 300W
②	Input voltage	48: 36V ~ 75V input range, rated input voltage 48V
③	Output number	S: single output
④	Rated output voltage	12: 12V output
⑤	Baseplate status	B: with baseplate; default: open frame
⑥	Pin length	6: 3.8mm 4: 4.6mm
⑦	RoHS status	RoHS 3.0
⑧	PMBus™ interface	I: available; default: don't support

Options

None

ELECTRICAL SPECIFICATIONS

Absolute Maximum Ratings

Stress in excess of those listed in the “Absolute Maximum Ratings” may cause permanent damage to the power supply. These are stress ratings only and functional operation of the unit is not implied at these or any other conditions above those given in the operational sections of this TRN. Exposure to any absolute maximum rated condition for extended periods may adversely affect the power supply’s reliability.

Table 1. Absolute Maximum Ratings						
Parameter	Model	Symbol	Min	Typ	Max	Unit
Input Voltage Operating-Continuous Non-operating -100mS	All modules	$V_{IN,DC}$	-	-	78	Vdc
	All modules		-	-	95	Vdc
Maximum Output Power	All modules	$P_{O,max}$	-	-	300	W
Isolation Voltage ¹ Input to Output	All modules		-	-	1500	Vdc
Ambient Operating Temperature	All modules	T_A	-40	-	+85	°C
Storage Temperature	All modules	T_{STG}	-55	-	+125	°C
Voltage at remote ON/OFF pin	All modules		-0.3	-	15	Vdc
Logic pin voltage (to SIG_GND or Vo-), such as TRIM/C1, C2, ADDR0, ADDR1, CLK, DATA, SMBALERT.	All modules		-0.3	-	3.6	Vdc
Humidity (non-condensing) Operating Storage	All modules		-	-	95	%
	All modules		-	-	95	%

Note 1 - 1mA for 60s, slew rate of 1500V/10s. Functional insulation, pollution degree 2, input-metal part

ELECTRICAL SPECIFICATIONS

Input Specifications

Table 2. Input Specifications						
Parameter	Condition ¹	Symbol	Min	Typ	Max	Unit
Operating Input Voltage, DC	All	$V_{IN,DC}$	36	48	75	Vdc
Turn-on Voltage Threshold	All	$V_{IN,ON}$	31	-	36	Vdc
Turn-off Voltage Threshold	All	$V_{IN,OFF}$	30	-	35	Vdc
Input Under-voltage Lockout Hysteresis	All		1	-	3	Vdc
Input Over Voltage Protection	All		79	-	87	Vdc
Input Over Voltage Protection recovery voltage	All		78	-	86	Vdc
Input Over-voltage Lockout Hysteresis	All		1	-	-	Vdc
Maximum Input Current ($I_O = I_{O,max}$)	$V_{IN,DC} = 48Vdc$	$I_{IN,MAX}$	-	-	9.1	A
No Load Input Current	All		-	0.1	-	A
Standby Input current	Remote OFF		-	0.02	0.1	A
Recommended Input Fuse	Fast blow external fuse recommended		-	-	15	A
Input filter component values (C\L)	Internal values		-	6.9\0.68	-	$\mu F\ \mu H$
Recommended External Input Capacitance	Low ESR capacitor recommended	C_{IN}	220	-	-	μF
Input Reflected Ripple Current	Through 12 μH inductor		-	100	300	mA
Operating Efficiency	$T_a = 25\ ^\circ C$ Airflow = 800LFM $V_{IN} = V_{IN,nom}$ $I_O = 100I_{O,max}$ $I_O = 60\%I_{O,max}$	η	- -	95.2 95.3	- -	% %

Note 1 - $T_a = 25\ ^\circ C$, $V_{in} = 48Vdc$, nominal V_{out} unless otherwise noted.

ELECTRICAL SPECIFICATIONS

Output Specifications

Table 3. Output Specifications							
Parameter	Condition ¹	Symbol	Min	Typ	Max	Unit	
Factory Set Voltage	$V_{IN,DC} = 48Vdc$ $I_O = 50\% I_{O,max}$	V_O	11.77	11.82	11.87	Vdc	
Total Regulation	Over sample, line, load, temperature & life	V_O	10.7	-	12.3	Vdc	
Output Voltage Line Regulation	$V_{IN} \geq 40V$	V_O	-	60	120	mV	
Output Voltage Load Regulation	$V_{IN} \geq 40V$	V_O	-	250	500	mV	
Output Voltage Trim Range		V_O	5.0		13.2	Vdc	
Output Voltage Temperature Regulation	All		-	-	0.02	%/°C	
Output Ripple, pk-pk	20MHz bandwidth	V_O	-	70	300	mV _{PK-PK}	
Output Current	All	I_O	0	-	26	A	
Output DC current-limit inception ²	All		28	-	48	A	
V_O Load Capacitance ³	All	C_O	380	-	5000	µF	
V_O Dynamic Response	Peak Deviation	50%~75%~50% slew rate = 1A/µs & 0.1A/µs	$\pm V_O$	-	200	-	mV
	Settling Time						
Turn-on transient	Rise time	$I_O = I_{O,max}$		-	-	80	mS
	Turn-on delay	By AC		-	-	160	mS
	Turn-on delay	By Enable All		-	-	50	mS
	Turn-On overshoot	All		-	-	600	mV
	Turn-Off Undershoot	All		-	-	600	mV
Switching Frequency	All	fsw	-	150	-	KHz	
Remote ON/OFF control (Negative (default); Positive available)	Off-state voltage	All		2.4	-	15	V
	On-state voltage	All		-0.3	-	0.8	V
Output Voltage Trim Range ⁴	Via trim pin		6	-	13.2	V	
	Via PMBus		5	-	13.2	V	

Note 1 - $T_A = 25^\circ C$, $V_{in} = 48Vdc$, nominal V_{out} unless otherwise noted.

Note 2 - Hiccup: auto-restart when over-current condition is removed.

Note 3 - 22µF*2 PCS Cap + Oscon.

Note 4 - See more details in "trim characteristic".

ELECTRICAL SPECIFICATIONS

Output Specifications

Table 3 Input Specifications						
Parameter	Condition ¹	Symbol	Min	Typ	Max	Unit
Output over-voltage protection ⁵	All	V_O	14	-	17	V
Output over-temperature protection ⁶	Open Frame	T	110	-	135	°C
	Baseplate	T	100	-	125	°C
Over-temperature hysteresis	All		5	-	-	°C
Parallel unit	All		-	-	2	Units
Current share	$I_O = (0\%-160\%) I_{O,max}$		-	-	10	%
Pre-bias	Rating $V_O@0A$ at 48V V_{in} , and the max pre-bias voltage shouldn't exceed 9.5V	V_O	30	-	95	%
MTBF	Airflow = 300LFM $T_A = 40^\circ C$ $V_{IN} = V_{IN,nom}$ $I_O = 80\% I_{O,max}$ Telcordia, SR332 Method 1 Case 3		-	1.5	-	10^6 h

Note 5 - Hiccup: auto-restart when over-voltage condition is removed.

Note 6 - Auto recovery. See Figure 10&12 test point.

ELECTRICAL SPECIFICATIONS

PMBUS signal interface characteristics:

Table 4 Input Specifications						
Parameter	Condition ¹	Symbol	Min	Typ	Max	Unit
Input high voltage(CLK,DATA)			2.1	-	3.3	V
Input low voltage(CLK,DATA)			0	-	0.8	V
Input high level current (CLK,DATA)			-10	-	10	uA
Output low voltage (SMBALERT ,CLK,DATA)	$I_o = 2\text{mA}$		-	-	0.4	V
Output high level open drain leakage current (SMBALERT, DATA)	$V_o = 3.6\text{V}$		0	-	10	uA
PMBUS operation frequency			100 or 400			KHz

Note 5 - Hiccup: auto-restart when over-voltage condition is removed.

Note 6 - Auto recovery. See Figure 10&12 test point.

Measurement system characteristics

Table 5 Measurement system characteristics:						
Parameter	Condition ¹	Symbol	Min	Typ	Max	Unit
Output current reading accuracy*	$12\text{A} < I_o < 25\text{A}$		-10	-	10	%
	$1\text{A} < I_o < 12\text{A}$		-3	-	3	A
Output current reading resolution*	$V_{IN,DC} > 40\text{Vdc}$		-	0.19	0.5	A
Vo reading accuracy			-2	1	2	%
Vo reading resolution			-	0.25	0.5	V
Vin reading accuracy			-4	-	4	%
Temperature reading accuracy	temperature above zero		-5	-	5	°C
Temperature reading resolution	temperature above zero		-	0.25	1	°C

ELECTRICAL SPECIFICATIONS

ADO300-48S12-6L Performance Curves

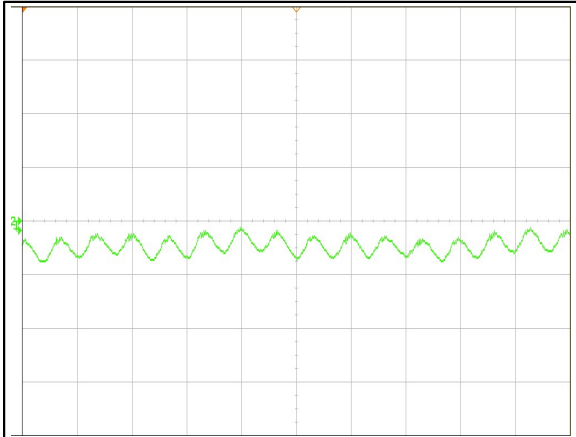

Figure 1: ADO300-48S12 Input Reflected Ripple Current Waveform
Ch 2: Iin (5uS/div, 20mA/div)

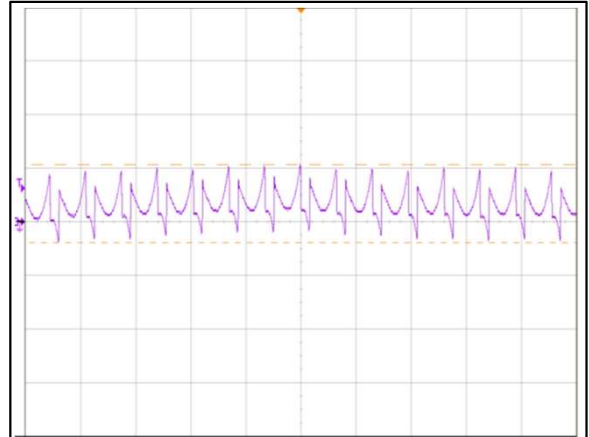

Figure 2: ADO300-48S12 Ripple and Noise Measurement
Ch 3: Vo (5uS/div, 20mV/div)

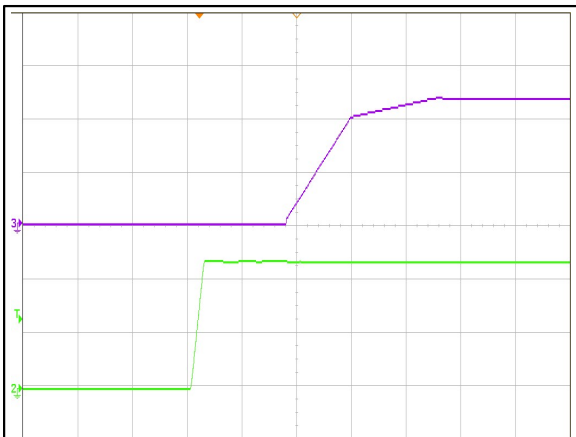

Figure 3: ADO300-48S12 Output Voltage Startup Characteristic (20mS/div)
Ch 3: Vo (5V/div) Ch 2: Vin (20V/div)

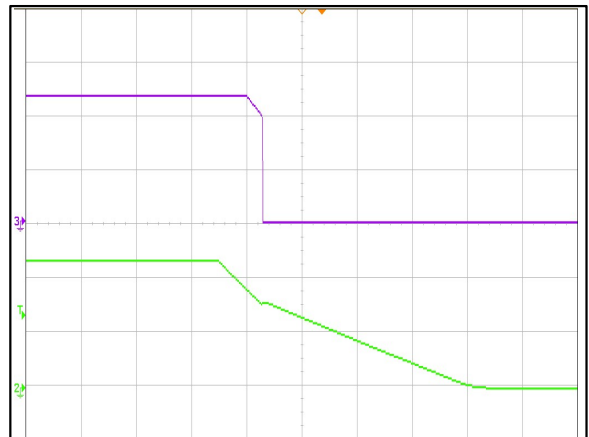

Figure 4: ADO300-48S12 Turn Off Characteristic (100mS/div)
Ch 3: Vo (5V/div) Ch 2: Vin (20V/div)

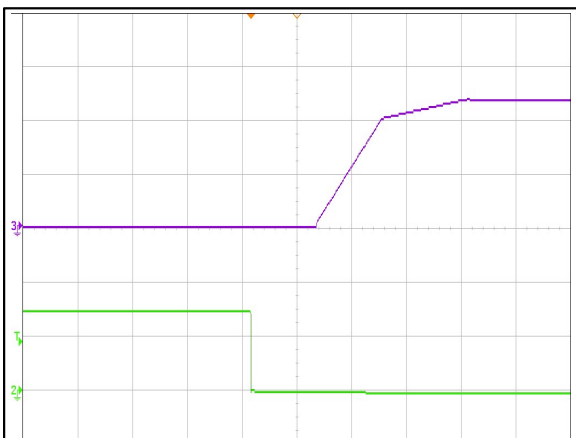

Figure 5: ADO300-48S12 Remote ON Waveform (20mS/div)
Ch 3: Vo (5V/div) Ch 2: Remote ON (2V/div)

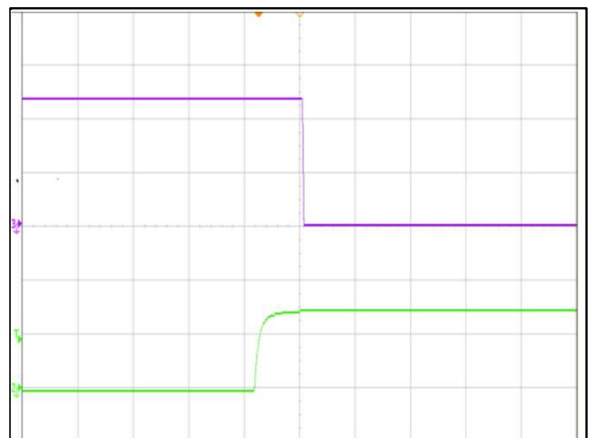

Figure 6: ADO300-48S12 Remote OFF Waveform (200mS/div)
Ch 3: Vo (5V/div) Ch 2: Remote ON (2V/div)

ELECTRICAL SPECIFICATIONS

ADO300-48S12 Performance Curves

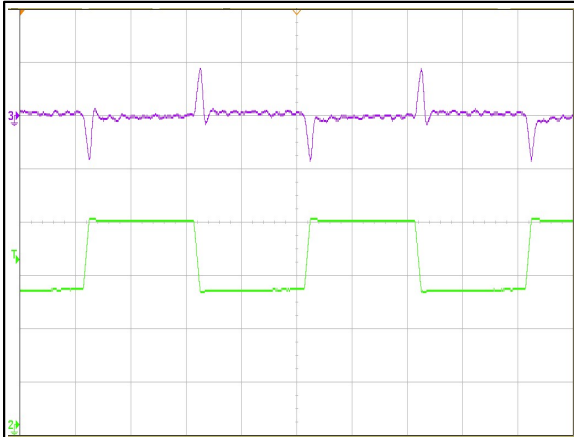

Figure 7: ADO300-48S12 Transient Response (500uS/div)
 50%~75%~50% load change, 0.1A/uS slew rate
 Ch 3: Vo (200mV/div) Ch 2: Io (5A/div)

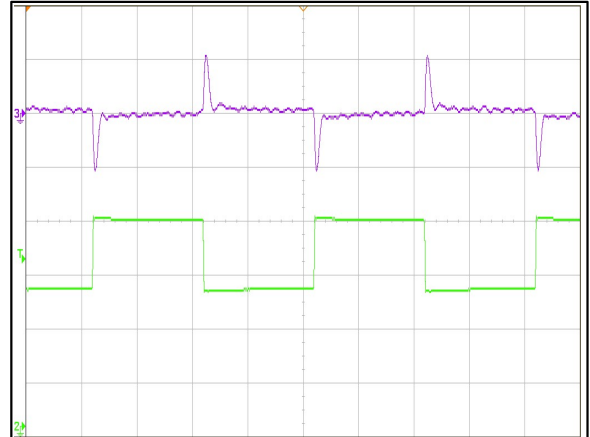

Figure 8: ADO300-48S12 Transient Response (500uS/div)
 50%~75%~50% load change, 1A/uS slew rate
 Ch 3: Vo (200mV/div) Ch 2: Io (5A/div)

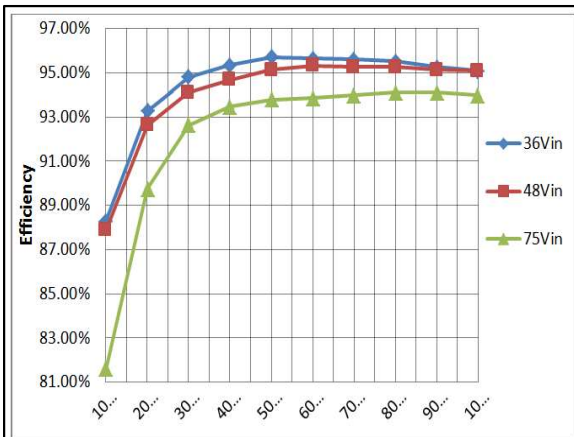

Figure 9: ADO300-48S12 Efficiency vs. output current, Ta=25oC,
 Vo=11.9V
 Loading: Io = 10% increment to 26A

ELECTRICAL SPECIFICATIONS

Protection Function Specifications

Input Fusing

An external fuse is recommended. To meet international safety requirements, a 250V rated fuse should be used. Recommended rating is 15A for the converter.

Note: The fuse is fast blow type.

Over Voltage Protection (OVP)

The output over-voltage protection consists of circuitry that monitors the voltage on the output terminals. When the over-voltage condition is removed, the converter will automatically restart.

Parameter	Min	Nom	Max	Unit
V _O Output Overvoltage	14	/	17	V

Over Current Protection (OCP)

When output current exceeds 110 to 144% of rated current, the converter will work on hiccup mode. When the over-current condition is removed, the converter will automatically restart.

Parameter	Min	Nom	Max	Unit
V _O Output Overcurrent	28	/	48	A

Over Temperature Protection (OTP)

The converter features an over-temperature protection circuit to safeguard against thermal damage. The converter will shutdown when the maximum device reference temperature is exceeded. When the over-temperature condition is removed, the converter will automatically restart.

Open-frame:

Parameter	Min	Nom	Max	Unit
V _O Output Over Temperature	110	/	135	°C

Base-plate:

Parameter	Min	Nom	Max	Unit
V _O Output Over Temperature	110	/	125	°C

MECHANICAL SPECIFICATIONS

Mechanical Outlines- Baseplate Module (unit: mm)

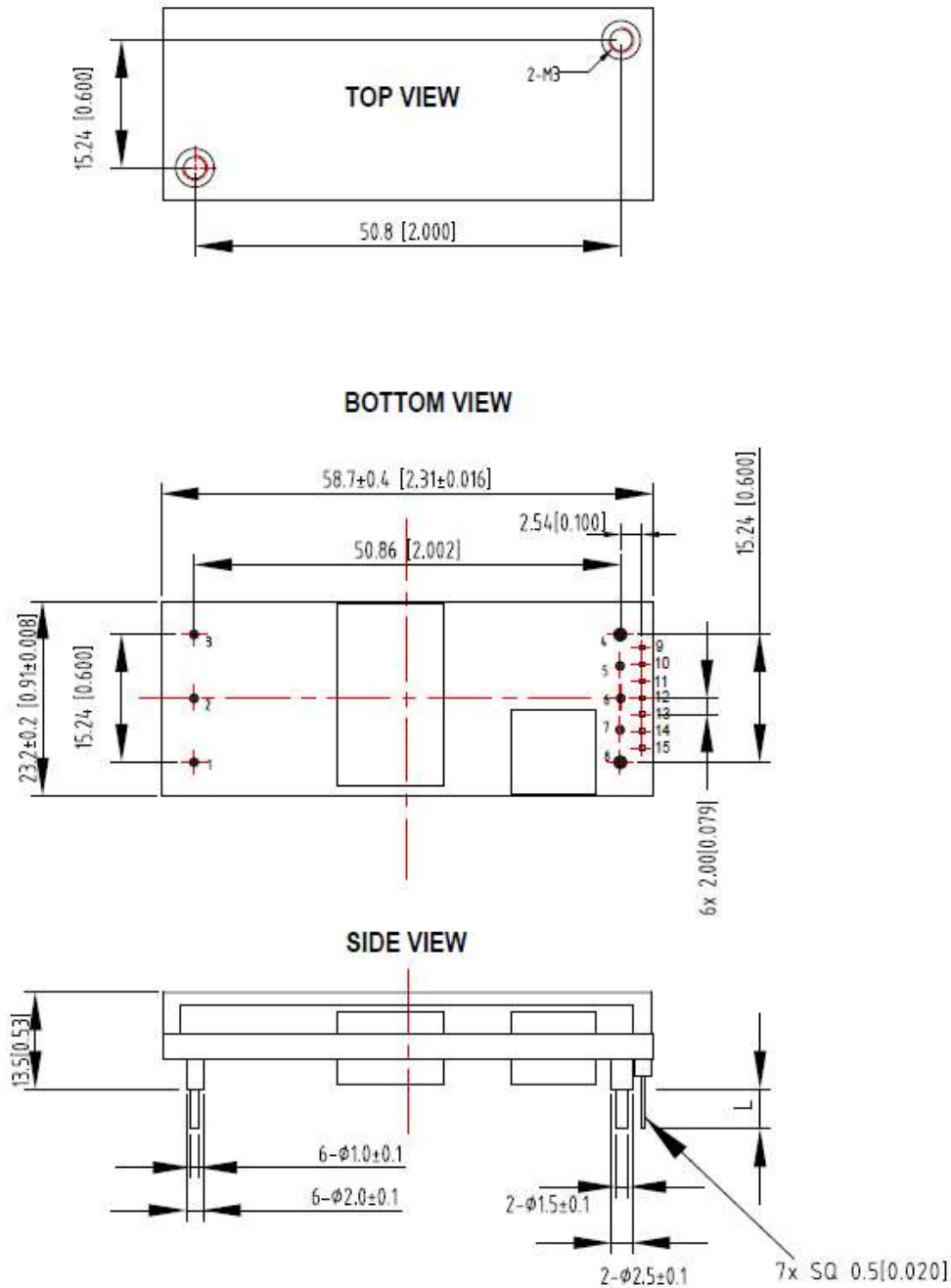

Unit: mm[inch] L: Refer to pin length option
 Tolerance: X.Xmm±0.5mm[X.XX in.±0.02in.]
 X.XXmm±0.25mm[X.XXX in.±0.01in.]

Note: Depth penetration into base plate, of M3 screws used at baseplate mounting holes, not to exceed maximum of 3.0mm.

MECHANICAL SPECIFICATIONS

Pin Length Option

Device code suffix	L
-4	4.8mm ± 0.25 mm
-6	3.8mm ± 0.25 mm
-8	2.8mm ± 0.25 mm
None	5.8mm ± 0.25 mm

Pin Designations

Pin No	Name	Function	Optional
1	Vin+	Positive input voltage	
2	Remote ON/OFF	Remote control	
3	Vin-	Negative input voltage	
4	Vo-	Negative output voltage	
5	-Sense	Remote sense negative	Yes
6	trim/C1	Voltage adjustment	Yes
7	+Sense	Remote sense positive	Yes
8	Vo+	Positive output voltage	
9	C2	Digital	Yes
10	Sig_Gnd		
11	Data		
12	SMBAAlert		
13	Clock		
14	Addr1		
15	Addr0		

ENVIRONMENTAL SPECIFICATIONS

EMC Immunity

ADO300-48S12 series power supply is designed to meet the following EMC immunity specifications.

Table 6. Environmental Specifications		
Document	Description	Criteria
EN55022 DC input port, Class B Limits	Conducted Emission	EN55022 DC input port, Class B Limits
IEC/EN 61000-4-2 Enclosure Port, Level 3	Immunity to Electrostatic Discharge	IEC/EN 61000-4-2 Enclosure Port, Level 3
IEC/EN 61000-4-6, DC input port, Level 2	Immunity to Continuous Conducted Interference	IEC/EN 61000-4-6, DC input port, Level 2
IEC/EN 61000-4-4 DC input port, Level3	Immunity to Electrical Fast Transient	IEC/EN 61000-4-4 DC input port, Level3
IEC/EN 61000-4-5 DC input port	Immunity to Surges Line to Ground(earth): 600V Line to Line: 600V	IEC/EN 61000-4-5 DC input port
EN61000-4-29 DC input port	Immunity to Voltage Dips and Short Interruptions and Voltage Variations	EN61000-4-29 DC input port

Criterion A: Normal performance during and after test.

Criterion B: Output voltage fluctuation or reset is allowed during the test, but recovers to its normal performance automatically after the disturbance ceases.

Criterion C: Temporary loss of output, the correction of which requires operator intervention.

Criterion D: Loss of output which is not recoverable, owing to damage to hardware.

ENVIRONMENTAL SPECIFICATIONS

Safety Certifications

The ADO300-48S12 power supply is intended for inclusion in other equipment and the installer must ensure that it is in compliance with all the requirements of the end application. This product is only for inclusion by professional installers within other equipment and must not be operated as a stand alone product

Table 7. Safety Certifications for ADO300-48S12 power supply system	
Document	Description
UL/CSA 60950	US and Canada Requirements
EN62368	European Requirements
CE	CE Marking
UL94	Materials meet V-0 flammability rating
TUV	International Requirements

ENVIRONMENTAL SPECIFICATIONS

Operating Temperature

The ADO300-48S12 series module will start and operate within stated specifications at an ambient temperature from -40 °C to 85 °C under all load conditions. The storage temperature is -55 °C to 125 °C.

Thermal Considerations - Base plate module

The converter is designed to operate in different thermal environments and sufficient cooling must be provided. For a typical application, There is the thermal derating data of output current vs. ambient air temperature at different air velocity @48Vin for baseplate module in Figure 12b. The temperature at these test points recommend not exceed the values in Table 6.

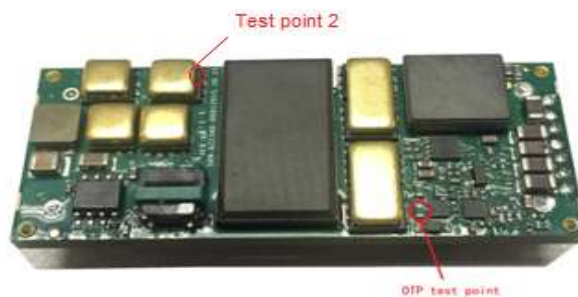

Figure 10 Temperature test point

Table 8 Temperature limit of the test point	
Test Point	Temperature Limit (°C)
OTP test point	109
Test point2	129

For a typical application, figure 11 shows the derating of output current vs. ambient air temperature at different air velocity @48V input.

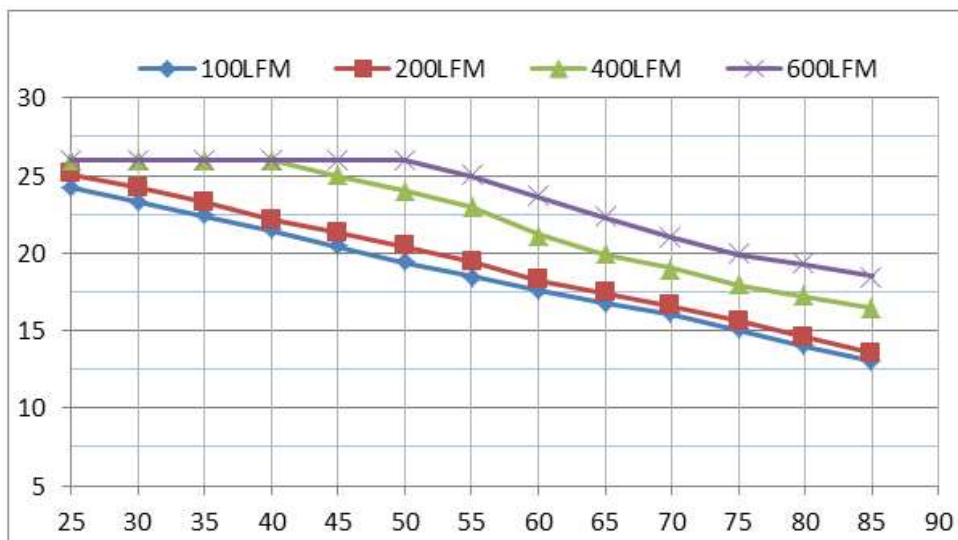

Figure 11 Derating curve

ENVIRONMENTAL SPECIFICATIONS

Thermal Considerations – Baseplate module

ADO300-48S12B is designed to operate in different thermal environments and sufficient cooling must be provided. Proper cooling can be verified by measuring the temperature at the test points as shown in the Figure 12. The temperature at these test points should not exceed the maximum values in Table 9.

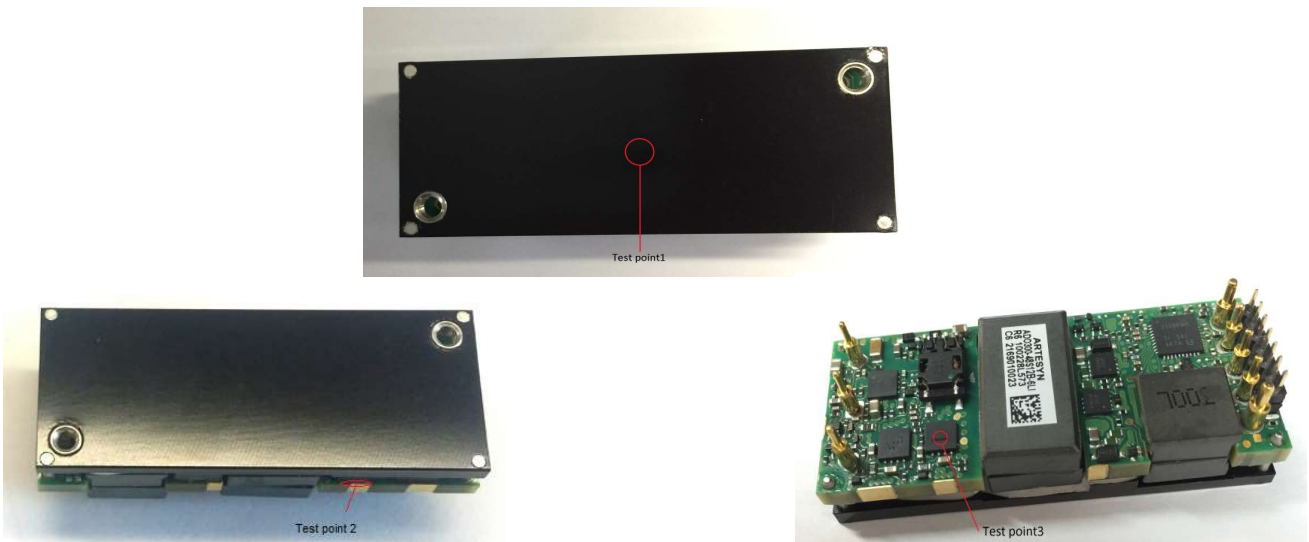

Figure 12 Temperature test point

Table 9 Temperature limit of the test point	
Test Point	Temperature Limit (°C)
Test point1	105
Test point2	128
Test point3	118

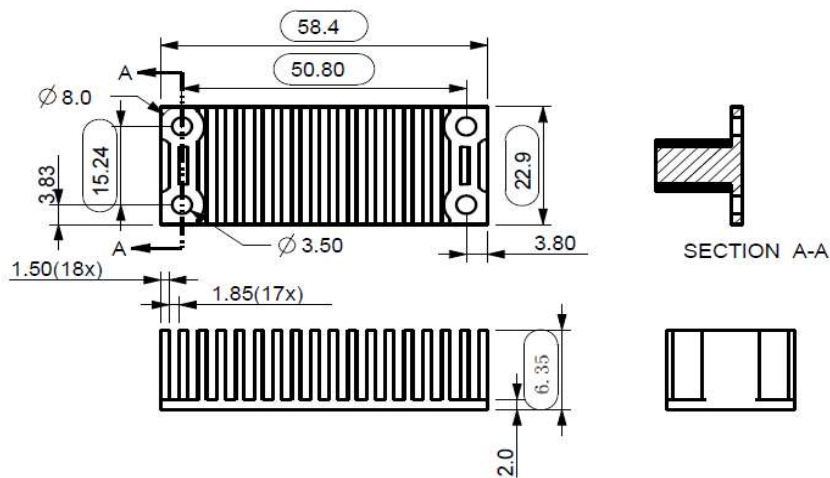

Figure 13

ENVIRONMENTAL SPECIFICATIONS

For a typical application, figure 14 shows the derating of output current vs. ambient air temperature at different air velocity@48V input with a 0.25" heat sink. The heat sink specification is shown in Figure13.

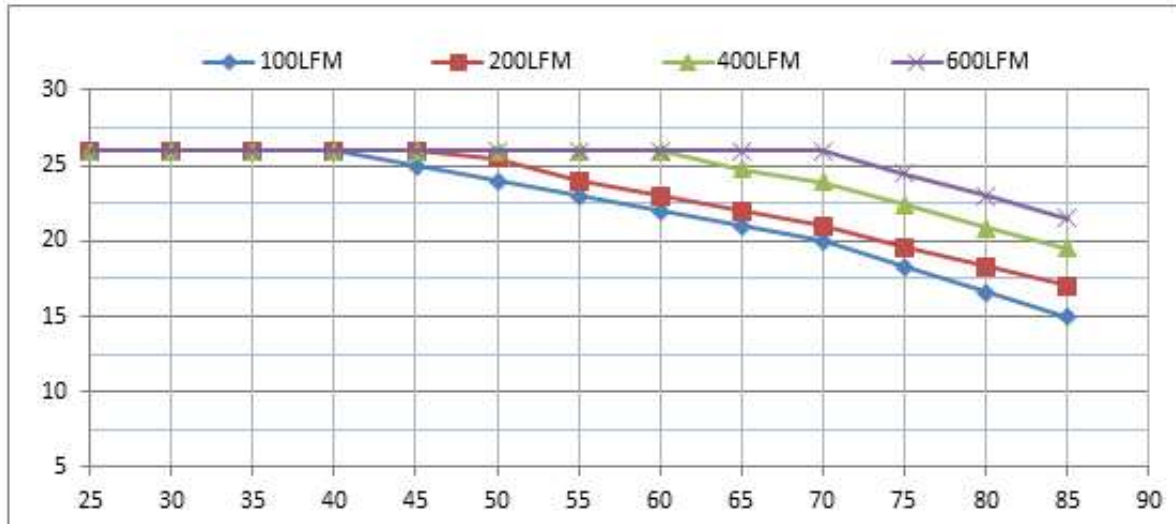

Figure 14 ADO300-48S12B with 0.25" heat sink, output power derating at 48V_{in}, air flowing across the converter from Vin- to Vin+

ENVIRONMENTAL SPECIFICATIONS

Parameter	Unit (pcs)	Test condition
Halt test	4-5	Ta,min -20°C to Ta,max+25°C, 10°C step, Vin = min to max, 0 ~ 100% load
Vibration	3	Frequency range: 5Hz ~ 20Hz, 20Hz ~ 200Hz, A.S.D: 1.0m2/s3, -3db/oct, axes of vibration: X/Y/Z. Time: 30min/axis
Mechanical Shock	3	Type: half sine, Acceleration: 30g, Duration: 6ms, Directions:6, Number of shock: 3times/face
Thermal Shock	3	-55°C to 125°C Temp Dwell Time:30min, Temp change rate: 20°C/min, Unit temperature 20cycles
Thermal Cycling	3	-40°C to 85°C, temperature change rate: 1°C/min, cycles: 2cycles
Humidity	3	40°C, 95%RH, 48h
Solder Ability	15	IPC J-STD-002C-2007

APPLICATION NOTES

Typical Application

Below is the typical application of the ADO300-48S12 series power supply.

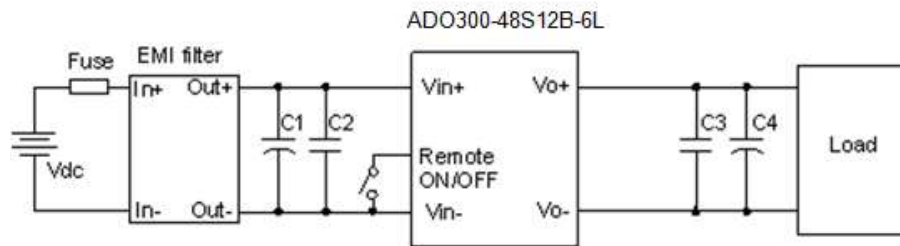

Figure 15 Typical application

C1: 220 μ F/100V electrolytic capacitor, P/N: UPM2A221MPD (Nichicon) or equivalent caps.

C2: 0.1 μ F/100V X7R ceramic capacitor.

C3: 2PCS 22 μ F/16V/X7S capacitor.

C4: 1000 μ F/25V electrolytic capacitor, OSK or POSCAP.

Fuse: External fast blow fuse with a rating of 15A/250Vac. The recommended fuse model is 0314015.P from Karwin Tech limited.

EMI Filter: refer to U1 in Figure 19.

APPLICATION NOTES

Configurable Control Pins

The module contains two configurable control pins, Trim /C1 and C2, referenced to the module secondary SIG_GND. See Mechanical Views for pin locations. The following table list the default factory configurations for the functions assigned to these pins. Additional configurations can be accomplished via the PMBus™ command. Following the table, there is a feature description for each function.

Pin Designation/Function		Configuration
Trim/C1	C2	
Trim	Power Good	Factory Default
On/Off	Power Good	Via PMBus™
Trim	On/Off	Via PMBus™

Remote ON/OFF

Standard Negative remote ON/OFF logic is available in the module . The logic is CMOS and TTL compatible. Remote ON/OFF (ENABLE) can be controlled by an external switch between the on/off terminal and the Vin(-) terminal. The switch can be an open collector or open drain. The voltage between pin Remote ON/OFF and pin Vin- must not exceed the range listed in table “Feature characteristics” to ensure proper operation. The external Remote ON/OFF circuit is highly recommended as shown in figure 16. For the negative logic, if the remote ON/OFF (ENABLE) feature is not used, please maintain the ENABLE pin to Vin(-).

Secondary Remote On/Off

The module contains an additional secondary remote on/off control, via either the Trim/C1 or C2 pin, reference to the output SIG_GND pin. And such pin can be reconfigured as secondary remote on/off pin by the PMBus™ interface including either negative or positive logic. Negative logic turns the module on during a logic low and off during a logic high. Positive logic turns the modules on during a logic high and off during a logic low. The secondary remote on/off can be controlled by an external switch between Trim/C1 or C2 and output SIG_GND pin. The switch can be an open collector or open drain, see Figure 15. If not using the Secondary remote on/off control, the pin may be left N/C.

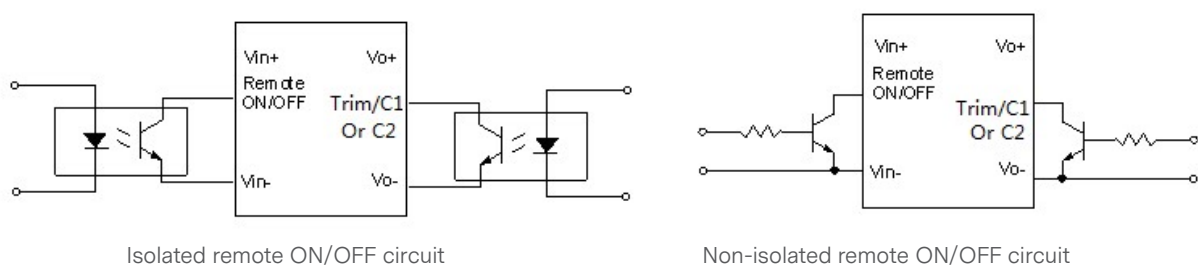

Figure 16 Typical application

APPLICATION NOTES

Parallel and Droop Current Sharing

The module is capable of operating in parallel, and realizing current sharing by droop current sharing method. There is about 150mV output voltage droop from 0A to full output Load, and there is no current sharing pin. By connecting the Vin pin and the Vo pin of the parallel module together, the current sharing can be realized automatically.

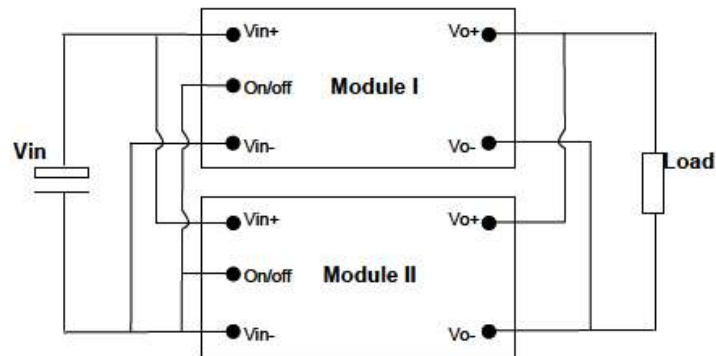

Figure17 Parallel and droop current sharing configuration for no redundancy requirement system

If system has no redundancy requirement, the module can be parallel directly for higher power without adding external oring-fet; whereas, if the redundancy function is required, the external oring-fet should be added.

For a normal parallel operation the following precautions must be observed:

1. The current sharing accuracy equation is:

$$X\% = \left| I_o - \left(I_{total} / N \right) \right| / I_{rated}$$

Where, I_o is the output current of per module; I_{total} is the total load current; N is parallel module numbers; I_{rated} is the rated full load current of per module.

2. To ensure a better steady current sharing accuracy, below design guideline should be followed:

- The inputs of the converters must be connected to the same voltage source; and the PCB trace resistance from Input voltage source to V_{in+} and V_{in-} of each converter should be equalized as much as possible.
- The PCB trace resistance from each converter's output to the load should be equalized as much as possible.
- For accurate current sharing accuracy test, the module should be soldered in order to avoid the unbalance of the touch resistance between the modules to the test board.

3. To ensure the parallel module can start up monotonically without triggering the OCP circuit, below design guideline should be followed:

- Before all of the parallel modules finished start up and PG signal asserts, the total load current should be lower than the rated current of 1 module.
- The ON/OFF pin of the converters should be connected together to keep the parallel modules start up at the same time.
- The under voltage lockout point will slightly vary from unit to unit. The dv/dt of the rising edge of the input source voltage must be greater than 1V/ms to ensure that the parallel module start up at the same time.

4. If fault tolerance is desired in parallel applications, output ORing devices should be used to prevent a single module failure from collapsing the load bus.

APPLICATION NOTES

Power Good, PG

The module provides a Power Good (C2 Pin) feature, to indicate that the output voltage is within the normal output voltage range of the power module. The PG signal will be de-asserted to a low state if any condition such as over temperature, over current, UVLO, OVP, loss of regulation occurs that would result in the output voltage going below the normal voltage range value.

Before all of the parallel modules finished start up and PG signal asserts, the total load current should be lower than the rated current of 1 module.

The PG signal, provided on pin C2, pulled up via a $3.3k\Omega$ resistor to 3.3V internally. For Positive Logic PG (default), the PG signal is HI, when PG is asserted.

If not using the Power Good feature, the pin may be left N/C.

Remote Sense

If the load is far from the unit, connect S+ and S- to the terminal of the load respectively to compensate the voltage drop on the transmission line.

If the sense compensate function is not necessary, connect S+ to Vo+ and S- to Vo- directly.

Input Ripple & Inrush Current and Output Ripple & Noise Test Configuration

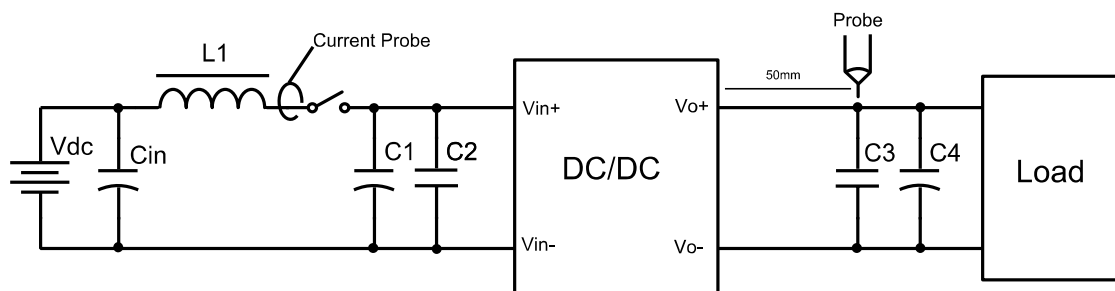

Figure 18 Input ripple & inrush current output ripple & noise test configuration

Vdc: DC power supply

L1: $12\mu\text{H}$

Cin: $220\mu\text{F}/100\text{V}$ typical

C1~C4: See Figure 19

Note: Using a coaxial cable with series 50Ω resistor and $0.68\mu\text{F}$ ceramic capacitor or a ground ring of probe to test output ripple & noise is recommended

APPLICATION NOTES

EMC test conditions

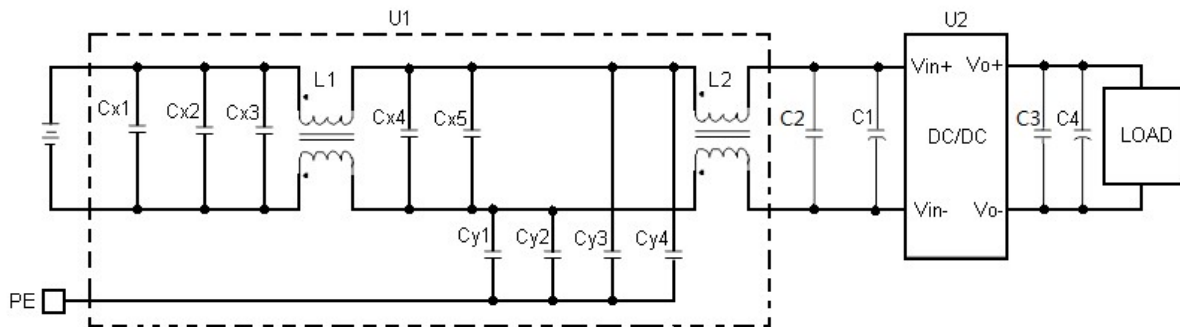

Figure 19 Typical application

C1: 220 μ F/100V electrolytic capacitor, P/N: UPM2A221MPD (Nichicon) or equivalent caps

C2: 0.1 μ F/100V/X7R capacitor

C3: 22 μ F/16V/X7S *2 PCS capacitor

C4: 1000 μ F/25V electrolytic capacitor, P/N: OSK or POSCAP

U1: Input EMC filter

U2: Module to test, ADO300-48S12B-6L

C_{x1}, C_{x2}, C_{x3}, C_{x4}, C_{x5}: 1 μ F/100V/X7R capacitor

C_{y1}, C_{y2}, C_{y3}, C_{y4}: 0.88 μ F/630V/X7R, Y capacitor

L1, L2: 473 μ H, common mode inductor

Fuse: External fast blow fuse with a rating of 15A/250Vac. The recommended fuse model is 0314015.P from Karwin Tech limited.

APPLICATION NOTES

Trim Characteristics

To increase or decrease the output voltage set point, an external resistor is connected between the trim pin and either the Vo+ or Vo-. The trim pin should be left open if this feature is not used. Below Trim equation is only adapt to the module without droop current sharing option code. For the module with droop current sharing option code, please contact Artesyn's technical support team.

Connecting an external resistor between Trim pin and Vo- pin will decrease the output voltage. While connection it between Trim and Vo+ will increase the output voltage. The following equations determine the external resistance to obtain the trimmed output voltage.

$$R_{adj-down} = \frac{511}{\Delta} - 10.22(K\Omega)$$

$$R_{adj-up} = \frac{5.11 \times V_{nom} \times (100 + \Delta)}{1.225 \times \Delta} - \frac{511}{\Delta} - 10.22(K\Omega)$$

Δ : Output voltage change rate against nominal output voltage.

$$\Delta = \frac{100 \times |V_{nom} - V_o|}{V_{nom}}$$

V_{nom} :Nominal output voltage.

For example, to get 13.2V output, the trimming resistor is

$$\Delta = \frac{100 \times |V_{nom} - V_o|}{V_{nom}} = \frac{100 \times |12 - 13.2|}{12} = 10$$

$$R_{adj-up} = \frac{5.11 \times 12 \times (100 + 10)}{1.225 \times 10} - \frac{511}{10} - 10.22 = 489.3(K\Omega)$$

The output voltage can also be trimmed by potential applied at the Trim pin.

$$V_o = (V_{trim} + 1.225) \times 4.8571$$

Where V_{trim} is potential applied at the Trim pin, and V_o is the desired output voltage.

When trimming up, the output current should be decreased accordingly so as not to exceed the maximum output power.

APPLICATION NOTES

The output adjustable range by trim pin is 6V~13.2V; If by PMBus function, the output adjustable range is 5V ~13.2V.

When $V_{in} \geq 44V$, module can trim up. When trim up, the $V_{inmin} = 44V$ at current share. About trim up and down function, we can choose one way between External Resistor and Adjustable via PMBus. As show in the figure20 is the typical output voltage vs. input voltage.

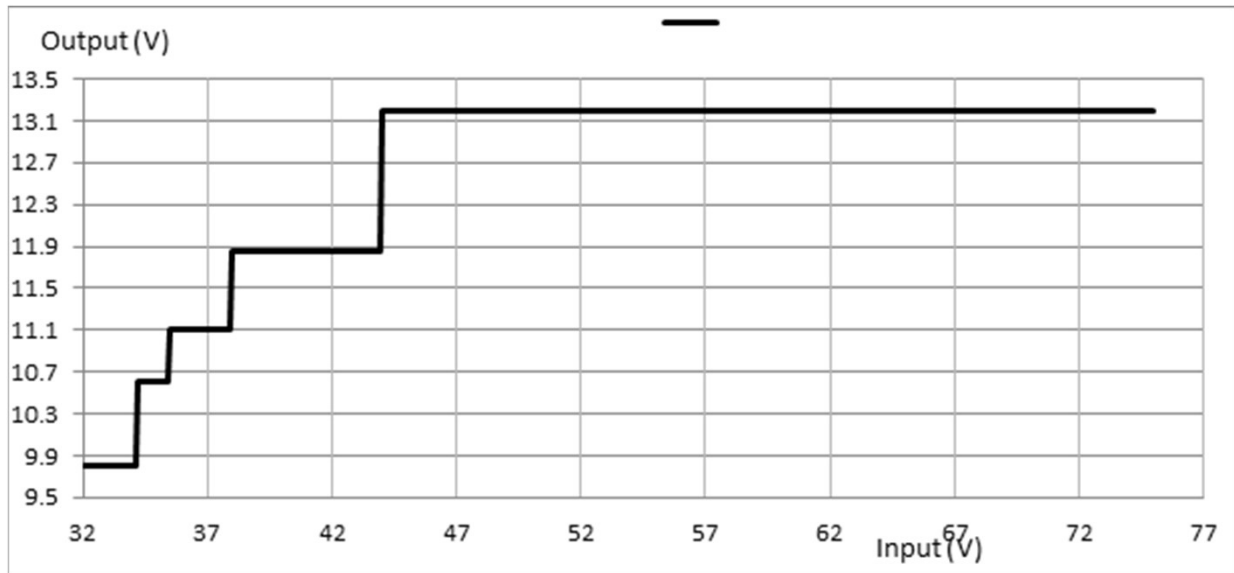

Figure 20 Typical output voltage vs. input voltage

PMBus™ SPECIFICATIONS

PMBus™ communication

Digital Feature Descriptions

The ADO300-48S12B-6LI is equipped with digital PMBus™ interface to allow the module configured and communicate with system controllers. Detailed timing and electrical characteristics of the PMBus™ can be found in the PMB Power Management Protocol Specification, Part 1, revision 1.2, available at <http://PMBUS.org>. The ADO300-48S12B-6LI supports both 100 kHz and 400 kHz bus timing requirements. The ADO300-48S12B-6LI shall stretch the clock, as long as it does not exceed the maximum clock LO period of 35ms. The ADO300-48S12B-6LI will check the Packet Error Checking scheme (PEC) byte, if provided by the PMBus™ master, and include a PEC byte in all responses to the master. The ADO300-48S12B-6LI supports a subset of the commands in the PMBUS 1.2 specification. Most all of the controller parameters can be programmed using the PMBus™ and stored as defaults for later use. All commands that require data input or output use the linear format. The supported commands are described in greater detail below. The ADO300-48S12B-6LI contains non-volatile memory that is used to store configuration settings and scale factors. The settings programmed into the device are not automatically saved into this non-volatile memory though. The STORE_DEFAULT_ALL command must be used to commit the current settings to non-volatile memory as device defaults. The settings that are capable of being stored in non-volatile memory are noted in their detailed descriptions.

PMBus Addressing

The power module can be addressed through the PMBUS using a device address. The module has 36 possible addresses (between 0 to 63 in decimal) which can be set using resistors connected from the ADDR0 and ADDR1 pins to GND as the figure 22. Note that some of these addresses (0 through 12, 40, 44, 45, and 55 in decimal) are reserved according to the SMBus specifications and may not be useable. The address is set in the form of two octal (2 to 7) digits, with each pin setting one digit. The ADDR1 pin sets the high order digit and ADDR0 sets the low order digit. The resistor values suggested for each digit are shown in Table below (1% tolerance resistors are recommended).

Address = $8 \times \text{Addr1} + \text{Addr0}$

Digit	Resistor Value (KΩ)
2	23.7
3	36.5
4	54.9
5	84.5
6	130
7	200

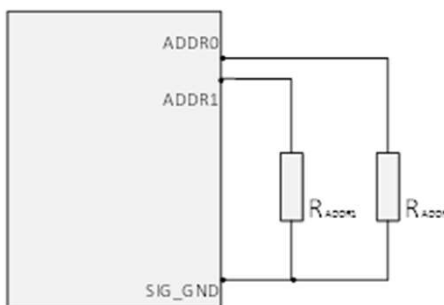

The user must know which I2C addresses are reserved in a system for special functions and set the address of the module to avoid interfering with other system operations. Both 100 kHz and 400 kHz bus speeds are supported by the module. Connection for the PMBUS interface should follow the High Power DC specifications given in section 3.1.3 in the SMBus specification V2.0 for the 400 kHz bus speed or the Low Power DC specifications in section 3.1.2. The complete SMBus specification is available from the SMBus web site, smbus.org.

NOTES: * if ADDR1 pin or ADDR0 pin is floating, the device address is 48. ** if the resistor combination is configured as an invalid address (0 through 12, 40, 44, 45, and 55 in decimal), the device address is 48.

PMBus™ SPECIFICATIONS

PMBus™ Data Format

For commands that set or report any voltage thresholds related to output voltage (including VOUT_COMMAND, VOUT_MARGIN, POWER_GOOD and READ_VOUT), the module supports the linear data format consisting of a two byte value with a 16-bit, unsigned mantissa, and a fixed exponent of -9. The format of the two data bytes is shown below:

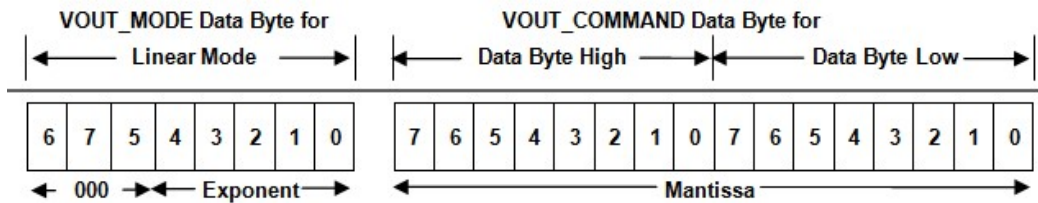

The value of the number is then given by $\text{Value} = \text{Mantissa} \times 2^{-9}$

For commands that set all other thresholds, voltages or report such quantities, the module supports the linear data format consisting of a two byte value with an 11-bit, two's complement mantissa and a 5-bit, two's complement exponent. The format of the two data bytes is shown below:

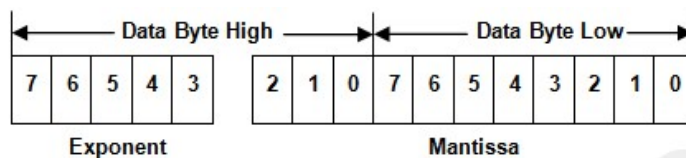

The value of the number is then given by $\text{Value} = \text{Mantissa} \times 2^{\text{Exponent}}$

PMBUS Enabled On/Off

The module can also be turned on and off via the PMBUS interface. The OPERATION command is used to actually turn the module on and off via the PMBUS, Bit [7] in the OPERATION command data byte enables the module, with the following functions:

- 0: Output is disabled
- 1: Output is enabled

PMBus™ SPECIFICATIONS

PMBUS Adjustable Input Under voltage Lockout

The module allows adjustment of the input under voltage lockout and hysteresis. The command VIN_ON allows setting the input voltage turn on threshold, while the VIN_OFF command sets the input voltage turn off threshold. For both the VIN_ON and VIN_OFF commands, possible values range from 31.000 to 36.000V in 0.1V steps. VIN_ON must be 1.5V greater than VIN_OFF. The data associated with VIN_ON and VIN_OFF can be stored to non-volatile memory using the STORE_DEFAULT_ALL command.

PMBUS Adjustable Soft Start Delay and Rise Time

The soft start delay and rise time can be adjusted in the module via PMBUS. The TON_DELAY command sets the delay time in ms, and allows choosing delay times between 10ms and 500ms, with resolution of 0.1ms. The TON_RISE command sets the rise time in ms, and allows choosing soft start times between 20ms and 500ms, with resolution of 0.1ms. When setting TON_RISE, make sure that the charging current for output capacitors can be delivered by the module in addition to any load current to avoid nuisance tripping of the over current protection circuitry during startup. The data associated with TON_RISE and TON_DELAY can be stored to non-volatile memory using the STORE_DEFAULT_ALL command.

- For parallel applications, suggest use factory default parameter for rise time, Vout_droop, Turn-on delay time and so on.

Output Voltage Adjustment Using the PMBUS

The ADO300-48S12B-6LI module output voltage set point is adjusted using the VOUT_COMMAND. The output voltage setting uses the Linear data format, with the 16 bits of the VOUT_COMMAND formatted as an unsigned mantissa, and a fixed exponent of -9 (decimal) (read from VOUT_MODE). $VOUT = \text{Mantissa} \times 2^{-9}$

The range limits for VOUT_COMMAND are 5.00V to 13.20V, and the resolution is 1.171mV. The data associated with VOUT_COMMAND can be stored to non-volatile memory using the STORE_DEFAULT_ALL command.

Output Voltage Margining Using the PMBUS

The ADO300-48S12B-6LI module can also have its output voltage margined via PMBUS commands. The command VOUT_MARGIN_HIGH sets the margin high voltage, while the command VOUT_MARGIN_LOW sets the margin low voltage. Both the VOUT_MARGIN_HIGH and VOUT_MARGIN_LOW commands use the “Linear” mode with the exponent fixed at -9 (decimal). The data associated with VOUT_MARGIN_HIGH and VOUT_MARGIN_LOW can be stored to non-volatile memory using the STORE_DEFAULT_ALL command. The module is commanded to go to the margined high or low voltages using the OPERATION command. Bits [5:2] are used to enable margining as follows:

00XX	Margin
0110	Margin Low (Act on Fault)
1010	Margin High (Act on Fault)

Measuring Input Voltage Using the PMBUS

The module can provide input voltage information using the READ_VIN command. The command returns two bytes of data in the linear format. The upper five bits [7:3] of the high data byte form the two’s complement representation of the exponent. The remaining 11 bits are used for two’s complement representation of the mantissa. During module manufacture, offset and gain correction values are written into the non-volatile memory of the module to null errors in the tolerance and A/D conversion of Vin. The command MFR_VIN_READ_CAL_GAIN can be used to read the gain correction - two bytes consisting of a unsigned 16 bit number. The corrected input voltage reading is then given by:

$$V_{in}(\text{read}) = [(V_{in}(ad) + MFR_VIN_READ_CAL_OFFSET) \times MFR_VIN_READ_CAL_GAIN / 100]$$

PMBus™ SPECIFICATIONS

Measuring Output Current Using the PMBUS

The module measures output current by using the output filter inductor winding resistance as a current sense element. The module can provide output current information using the READ_IOUT command. The command returns two bytes of data in the linear format. The upper five bits [7:3] of the high data byte form the two's complement representation of the exponent. The remaining 11 bits are used for two's complement representation of the mantissa, with the 11th bit fixed at zero since only positive numbers are valid. The READ_IOUT command provides module average output current information. This command only supports positive current sourced from the module. If the converter is sinking current a reading of 0 is provided. Note that the current reading provided by the module is measured in the temperature.

Measuring the Temperature using the PMBUS

The module can provide temperature information using the READ_TEMPERATURE_1 command. The command returns two bytes of data in the linear format. The upper five bits [7:3] of the high data byte form the two's complement representation of the exponent. The remaining 11 bits are used for two's complement representation of the mantissa. Note that the module's temperature sensor is located close to the module hot spot OTP test point" (see Figure 10, and is subjected to temperatures higher than the ambient air temperature near the module. The temperature reading will be highly influenced by module load and airflow conditions.

Reading the Status of the Module using the PMBUS

The module supports a number of status information commands implemented in PMBUS. However, not all features are supported in these commands. A X in the FLAG cell indicates the bit is not supported.

STATUS_WORD: Returns two bytes of information with a summary of the module's fault/warning conditions.

High Byte

Bit Position	Flag	Default Value
15	VOUT fault	0
14	IOUT fault or warning	0
13	Input Voltage fault	0
12	X	0
11	POWER_GOOD#(is negated)	0
10	X	0
9	X	0
8	X	0

PMBus™ SPECIFICATIONS

Low Byte

Bit Position	Flag	Default Value
7	X	0
6	OFF	0
5	VOUT Over voltage	0
4	IOUT Over current	0
3	VIN Under voltage	0
2	Temperature	0
1	X	0
0	X	0

STATUS_VOUT: Returns one byte of information relating to the status of the module's output voltage related faults.

Bit Position	Flag	Default Value
7	VOUT OV Fault	0
6	X	0
5	X	0
4	X	0
3	X	0
2	X	0
1	X	0
0	X	0

STATUS_IOUT: Returns one byte of information relating to the status of the module's output current related faults.

Bit Position	Flag	Default Value
7	IOUT OC Fault	0
6	X	0
5	IOUT OC Warning	0
4	X	0
3	X	0
2	X	0
1	X	0
0	X	0

PMBus™ SPECIFICATIONS

STATUS_INPUT: Returns one byte of information relating to the status of the module's input voltage related faults.

Bit Position	Flag	Default Value
7	VIN OV Fault	0
6	X	0
5	X	0
4	VIN UV Fault	0
3	Module Off(Low VIN)	0
2	X	0
1	X	0
0	X	0

STATUS_TEMPERATURE: Returns one byte of information relating to the status of the module's temperature related faults.

Bit Position	Flag	Default Value
7	OT Fault	0
6	OT Warning	0
5	X	0
4	X	0
3	X	0
2	X	0
1	X	0
0	X	0

Summary of Supported PMBUS Commands

This section outlines the PMBUS command support for the bus converters. Each supported command is outlined in order of increasing command codes with a quick reference table of all supported commands included at the end of the section. Each command will have the following basic information.

Command Name [Code]

Command support

Data format

Factory default

Additional information may be provided in tabular form or other format, if necessary.

PMBus™ SPECIFICATIONS

OPERATION [0x01]

Command support: On/Off Immediate and Margins (Act on Fault). Soft off with sequencing not supported and Margins (Ignore Fault) not supported. Therefore bits 6, 3, 2, 1 and 0 set as read only at factory defaults

Format	8 bit unsigned (bit field)							
Bit Position	7	6	5	4	3	2	1	0
Access	r/w	r	r/w	r/w	r	r	r	r
Function	ON/OFF		Vout Command		N/A		N/A	
Default Value	1	0	0	0	1	0	0	0

CLEAR_FAULTS [0x03]

Command support: All functionality.

STORE_DEFAULT_ALL[0x11]

Command support: All functionality – Stores operating parameters to E²prom memory.

RESTORE_DEFAULT_ALL[0x12]

Command support: All functionality – Restores operating parameters from E²prom memory.

VOUT_MODE[0x20]

Command support: Supported. Factory default: 0x17 – indicates linear mode with exp = -9.

STATUS_TEMPERATURE: Returns one byte of information relating to the status of the module's temperature related faults.

Format	8 bit unsigned (bit field)							
Bit Position	7	6	5	4	3	2	1	0
Access	r	r	r	r	r	r	r	r
Function	Mode(linear)			2's complement exponent				
Default Value	0	0	0	1	0	1	1	1

PMBus™ SPECIFICATIONS

VOUT_COMMAND [0x21]

Data format: 16 bit unsigned mantissa (implied exponent per VOUT_MODE)

Factory default: 12.000V ($12.00 / 2^{-9} \rightarrow 6144 = 0x1800$)

Range limits (max/min): 13.200V/5.000V

Units: volt

Command support: Supported, except when Trim function is selected via MFR_C1_C2_ARA_CONFIG [0xE0].

VOUT_MARGIN_HIGH [0x25]

Range limits (max/min): 13.2/5.0

Units: volt

Command support: read/write support, full functionality except “Ignore faults”.

Note: Range cross-check - value must be greater than VOUT_MARGIN_LOW value.

VOUT_MARGIN_LOW [0x26]

Range limits (max/min): 13.2/5.0

Units: volt

Command support: read/write support, full functionality except “Ignore faults”.

Note: Range cross-check - value must be less than VOUT_MARGIN_HIGH value.

VIN_ON [0x35]

Range limits (max/min): 36/31

Units: volt

Command support: All functionality

Note: Special interlock checks between VIN_ON and VIN_OFF maintain a hysteresis gap of 1V minimum and do not allow the OFF level to be higher than and ON level.

VIN_OFF [0x36]

Range limits (max/min): 35/30

Units: volt

Command support: All functionality

Note: Special interlock checks between VIN_ON and VIN_OFF maintain a hysteresis gap of 1V minimum and do not allow the OFF level to be higher than and ON level

VOUT_OV_FAULT_LIMIT [0x40]

Range limits (max/min): 17/12 (See note 2)

Units: volt

Command support: All functionality

Note:

1. Range cross- check – value must be greater than VOUT_COMMAND value.
2. The maximum OV Fault Limit equals the output set point plus 5V, up to 17V. This is an automatic module protection feature that will override a user-set fault limit if the user limit is set too high.

PMBus™ SPECIFICATIONS

VOUT_OV_FAULT_RESPONSE [0x41]

Command support:

- Response settings (bits RSP0:1) – only a setting of 10, unit shuts down and responds according to the retry settings below, is supported.
- Retry settings (bits RS0:2) – only settings of 000 (unit does not attempt to restart on fault) and 111 unit continuously restarts (normal startup) while fault is present until commanded off, bias power is removed or another fault condition causes the unit to shutdown.
- Delay time setting (bits 0-2) – only DT0:2 = 0 (no delay) supported.
Default Settings: The default settings for the VOUT_OV_FAULT_RESPONSE command are;
- The unit shuts down in response to a VOUT over voltage condition.
- The unit will continuously restart (normal startup) while the VOUT over voltage condition is present until it is commanded off, bias power is removed or another fault condition causes the unit to shutdown.
- The shutdown delay is set to 0 delay cycles.

Format	8 bit unsigned (bit field)							
Bit Position	7	6	5	4	3	2	1	0
Access	r	r	r	r	r	r	r	r
Function	RSP[1]	RSP[0]	RS[2]	RS[1]	RS[0]	DT[2]	DT[1]	DT[0]
Default Value	1	0	1	1	1	0	0	0

IOUT_OC_FAULT_LIMIT [0x46]

Range limits (max/min): 40/20

Units: amp

Command support: All functionality

Note: Range cross-check – value must be greater than IOUT_OC_WARN_LIMIT value.

IOUT_OC_FAULT_RESPONSE [0x47]

Command support:

- Response settings (bits RSP0:1) – only settings of 11, unit shuts down and responds according to the retry settings below, is supported.
- Retry settings (bits RS0:2) – only settings of 000 (unit does not attempt to restart on fault) and 111 unit continuously restarts (normal startup) while fault is present until commanded off, bias power is removed or another fault condition causes the unit to shutdown.
- Delay time setting (bits 0-2) – only DT0:2 = 0 (no delay) supported.
Default Settings: The default settings for the IOUT_OC_FAULT_RESPONSE command are;
- The unit shuts down in response to an IOUT over current condition.
- The unit will continuously restart (normal startup) while the IOUT over current condition is present until it is commanded off, bias power is removed or another fault condition causes the unit to shutdown.
- The shutdown delay is set to 0 delay cycles.

Format	8 bit unsigned (bit field)							
Bit Position	7	6	5	4	3	2	1	0
Access	r	r	r	r	r	r	r	r
Function	RSP[1]	RSP[0]	RS[2]	RS[1]	RS[0]	DT[2]	DT[1]	DT[0]
Default Value	1	1	1	1	1	0	0	0

PMBus™ SPECIFICATIONS

IOUT_OC_WARN_LIMIT [0x4A]

Range limits (max/min): 40/10

Units: amp

Command support: read/write support, functionality complete

Note: Range cross-check – value must be less than IOUT_OC_FAULT_LIMIT value.

OT_FAULT_LIMIT [0x4F]

Range limits (max/min): 135/90

Units: degrees C.

Command support: All functionality

Note: Range cross-check – value must be greater than OT_WARN_LIMIT value.

OT_FAULT_RESPONSE [0x50]

Command support:

- Response settings (bits RSP0:1) – only setting of 10, unit shuts down and responds according to the retry settings below.
- Retry settings (bits RS0:2) – only settings of 000 (unit does not attempt to restart on fault) and 111 unit continuously restarts (normal startup) while fault is present until commanded off, bias power is removed or another fault condition causes the unit to shutdown.
- Delay time setting (bits 0-2) – only DT0:2 = 0 (no delay) supported.
Default Settings: The default settings for the OT_FAULT_RESPONSE command are;
- The unit shuts down in response to an over-temperature condition.
- The unit will continuously restart (normal startup) while the over-temperature condition is present until it is commanded off, bias power is removed or another fault condition causes the unit to shutdown.
- The shutdown delay is set to 0 delay cycles.

Format	8 bit unsigned (bit field)							
Bit Position	7	6	5	4	3	2	1	0
Access	r	r	r	r	r	r	r	r
Function	RSP[1]	RSP[0]	RS[2]	RS[1]	RS[0]	DT[2]	DT[1]	DT[0]
Default Value	1	0	1	1	1	0	0	0

OT_WARN_LIMIT [0x51]

Range limits (max/min): 135/90

Units: degrees C.

Command support: All functionality

Note: Range cross-check – value must be less than OT_FAULT_LIMIT value.

VIN_OV_FAULT_LIMIT [0x55]

Range limits (max/min): 87/79

Units: volt

Command support: All functionality

PMBus™ SPECIFICATIONS

VIN_OV_FAULT_RESPONSE [0x56]

Command support:

- Response settings (bits RSP0:1) – only settings of 11 (The device’s output is disabled while the fault is present.) is supported.
- Retry settings (bits RS0:2) – only settings of 000 unit does not attempt to restart on fault.
- Delay time setting (bits 0-2) – only DT0:2 = 0 (no delay) supported.
Default Settings: The default settings for the VIN_OV_FAULT_RESPONSE command are;
- The unit shuts down in response to a VIN over voltage condition.
- The unit will continuously prepares to restart (normal startup) while the VIN over voltage condition is present until it is commanded off, bias power is removed, the VIN over voltage condition is removed, or another fault condition causes the unit to shutdown.
- The shutdown delay is set to 0 delay cycles.

Format	8 bit unsigned (bit field)							
Bit Position	7	6	5	4	3	2	1	0
Access	r	r	r	r	r	r	r	r
Function	RSP[1]	RSP[0]	RS[2]	RS[1]	RS[0]	DT[2]	DT[1]	DT[0]
Default Value	1	1	0	0	0	0	0	0

POWER_GOOD_ON [0x5E]

Range limits (max/min): 13.2/5.0

Units: volt

Command support: full support

Note: Range cross-check – value must be greater than POWER_GOOD_OFF value by 1.6V.

POWER_GOOD_OFF [0x5F]

Range limits (max/min): 13.2/5.0

Units: volt

Command support: full support

Note: Range cross-check – value must be less than POWER_GOOD_ON value by 1.6V.

STATUS_WORD [0x79]

Command support: full implementation for supported functions (Note 1: Fans, MFR_SPECIFIC, Unknown not supported)

Format	8 bit unsigned (bit field)							
Bit Position	15	14	13	12	11	10	9	8
Access	r	r	r	r	r	r	r	r
Function	VOUT	I/POUT	INPUT	MFR_SPEC ¹	#PWR_GOOD	FAN ¹	OTHER ¹	UNKNOWN ¹

PMBus™ SPECIFICATIONS

Format	8 bit unsigned (bit field)							
Bit Position	7	6	5	4	3	2	1	0
Access	r	r	r	r	r	r	r	r
Function	BUSY ¹	OUTPUT_OFF	VOUT_OV_FAULT	IOUT_OC_FAULT	VIN_UV_FAULT	TEMP	CML ¹	NONE OF ABOVE ¹

Note 1 - Not supported

STATUS_VOUT [0x7A]

Command support: VOUT_OV_FAULT support, all bit reset supported

Format	8 bit unsigned (bit field)							
Bit Position	7	6	5	4	3	2	1	0
Access	r/reset ¹	r/reset	r/reset	r/reset	r/reset	r/reset	r/reset	r/reset
Function	VOUT_OV_FAULT	VOUT_OV_WARN ¹	VOUT_UV_WARN ¹	VOUT_UV_FAULT ¹	VOUT_MAX_WARN ¹	TON_MAX_FAULT ¹	TOFF_MAX_WARN ¹	VOUT_TRACKING_ERROR ¹

Note 1 - Not supported

STATUS_IOUT [0x7B]

Command support: IOUT_OC_FAULT support, all bit reset supported

Format	8 bit unsigned (bit field)							
Bit Position	7	6	5	4	3	2	1	0
Access	r/reset ¹	r/reset	r/reset	r/reset	r/reset	r/reset	r/reset	r/reset
Function	IOUT_OC_FAULT	IOUT_OC_LV_FAULT ¹	IOUT_OC_WARN	IOUT_UC_FAULT ¹	Current Share Fault ¹	In Power Limiting Mode ¹	POUT_OP_FAULT ¹	POUT_OP_WARN ¹

Note 1 - Not supported

STATUS_INPUT [0x7C]

Command support: full implementation for supported functions (Note 1: Fans, MFR_SPECIFIC, Unknown not supported)

Format	8 bit unsigned (bit field)							
Bit Position	7	6	5	4	3	2	1	0
Access	r/reset ¹	r/reset	r/reset	r/reset	r/reset	r/reset	r/reset	r/reset
Function	VIN_OV_FAULT	VIN_OV_WARN ¹	VIN_UV_WARN ¹	VIN_UV_FAULT	Unit Off(low input voltage)	IIN_OC_FAULT ¹	IIN_OC_WARN ¹	PIN_OP_WARN ¹

Note 1 - Not supported

PMBus™ SPECIFICATIONS

STATUS_TEMPERATURE [0x7D]

Format	8 bit unsigned (bit field)							
Bit Position	7	6	5	4	3	2	1	0
Access	r/reset ¹	r/reset	r/reset	r/reset	r/reset	r/reset	r/reset	r/reset
Function	OT_FAULT	OT_WARN	UT_WARN ¹	UT_FAULT ¹	reserved	reserved	reserved	reserved
Default Value	7	6	5	4	3	2	1	0

(1) Not supported

READ_VIN [0x88]

Command support: full support

READ_VOUT [0x8B]

Command support: full support

READ_IOUT [0x8C]

Command support: full support

READ_TEMPERATURE_1 [0x8D]

Command support: full support

MFR_VIN_READ_CAL_GAIN [0xD3]

Factory default: 0x2000

Range limits (max/min): 0x2666/0x1999

Command support: support for VIN gain calibration (factor in flash), lockout per MFR_DEVICE_TYPE

MFR_VIN_READ_CAL_OFFSET [0xD4]

Command support: support for VIN offset calibration (factor in flash), lockout per MFR_DEVICE_TYPE

MFR_FW_REV [0xDB]

Range limits (max/min): 0 - 0xff (0.00 – 15.15)

Units: N/A

Command support: full read support

PMBus™ SPECIFICATIONS

MFR_C1_C2_ARA_CONFIG [0xE0]

Command Code

Command support: full support.

Command	MFR_C1_C2_ARA_CONFIG							
Format	8 bit unsigned (bit field)							
Bit Position	7	6	5	4	3	2	1	0
Access	r	r	r	r/w	r/w	r/w	r/w	r/w
Function	Reserved			ARA	Assignment Table			
Default Value	0	0	0	0	0	0	0	0

Bit	Description	Value	Meaning
7:5	Reserved	000	Reserved
4	ARA	0	ARA not functional, module remains at resistor programmed address when SMBLAERT is asserted
		1	ARA functional, module responds to ARA only, when SMBLAERT is asserted
3:0	PIN Configuration	0000	T/C1 pin: ON/OFF (Secondary) C2 pin: POWER_GOOD
		0001	T/C1 pin: TRIM C2 pin: POWER_GOOD
		0010	T/C1 pin: TRIM C2 pin: ON/OFF (Secondary)

MFR_C2_LOGIC [0xE1]

Command Code

Command support: full support (bits 0 and 1) as follows

Command	MFR_C2_ARA_LOGIC								
Format	8 bit unsigned (bit field)								
Bit Position	7	6	5	4	3	2	1		0
Access	r	r	r	r	r	r	r/w		r/w
Function	Reserved						On/Off(primary & secondary) combination		logic
Default Value	0	0	0	0	0	0	0		0

PMBus™ SPECIFICATIONS

Bit	Description	Value	Meaning
7:2	Reserved	000000	Reserved
1	ON/OFF Configuration	0	Secondary side on/off pin state, when mapped to either T/C1 or C2, is ignored
		1	Secondary side on/off
0	Secondary Side ON/OFF Logic	0	Negative Logic (Low Enable: Input < 0.8V wrt Vout(-))
		1	Positive Logic (High Enable: Input > 2.0V wrt Vout(-))

MFR_PGOOD_POLARITY [0xE6]

Command support: full support (bit 0) as follows:

Bit 0:

0 = Negative PGOOD logic (module PGOOD asserted when pin is LO, PGOOD de-asserted when pin is HI)

1 = Positive PGOOD logic (module PGOOD de-asserted when pin is LO, PGOOD asserted when pin is HI)

Command	MFR_PGOOD_POLARITY							
Format	8 bit unsigned (bit field)							
Bit Position	7	6	5	4	3	2	1	0
Access	r	r	r	r	r	r	r	r/w
Function	Reserved							logic
Default Value	0	0	0	0	0	0	0	1

MFR_MODULE_DATE_LOC_SN [0x9C]

Command support: read/write support for 12 byte block, lockout per MFR_DEVICE_TYPE

PMBus™ SPECIFICATIONS

PMBus™ Command Quick Reference Table

Command Code	Command Name	Default Value	Access Type	Data Bytes	Transfer type	Data Format	Date Unit
0x01	OPERATION	0x80	R/W	1	byte	Bit field	N/A
0x03	CLEAR_FAULTS	none	Send	0	byte	N/A	N/A
0x11	STORE_DEFAULT_ALL	none	Send	0	byte	N/A	N/A
0x12	RESTORE_DEFAULT_ALL	none	Send	0	byte	N/A	N/A
0x20	VOUT_MODE	0x17	Read	1	byte	mode + exp	N/A
0x21	VOUT_COMMAND	12.000V	R/W	2	word	VOUT linear	Volts
0x25	VOUT_MARGIN_HIGH	13.200V	R/W	2	word	VOUT linear	Volts
0x26	VOUT_MARGIN_LOW	5.000V	R/W	2	word	VOUT linear	Volts
0x28	VOUT_DROOP	6	R/W	2	word	VOUT linear	mV/A
0x35	VIN_ON	34.000V	R/W	2	word	linear11	V
0x36	VIN_OFF	32.000V	R/W	2	word	linear11	V
0x40	VOUT_OV_FAULT_LIMIT	15.000V	R/W	2	word	VOUT linear	V
0x41	VOUT_OV_FAULT_RESPONSE	0xB8	Read	1	byte	Bit field	N/A
0x46	IOUT_OC_FAULT_LIMIT	35.000A	R/W	2	word	linear11	Amps
0x47	IOUT_OC_FAULT_RESPONSE	0xF8	Read	1	byte	Bit field	N/A
0x4A	IOUT_OC_WARN_LIMIT	28.000A	R/W	2	word	linear11	Amps
0x4F	OT_FAULT_LIMIT	115°C	R/W	2	word	linear11	Deg. C
0x50	OT_FAULT_RESPONSE	0xB8	Read	1	byte	Bit field	N/A
0x51	OT_WARN_LIMIT	96°C	R/W	2	word	linear11	Deg. C
0x55	VIN_OV_FAULT_LIMIT	85V	R/W	2	word	linear11	V
0x56	VIN_OV_FAULT_RESPONSE	0xC0	Read	1	byte	Bit field	N/A
0x5E	POWER_GOOD_ON	10.100V	R/W	2	word	VOUT linear	V
0x5F	POWER_GOOD_OFF	8.500V	R/W	2	word	VOUT linear	V
0x60	TON_DELAY	20ms	R/W	2	word	linear11	mSec

PMBus™ SPECIFICATIONS

PMBus™ Command Quick Reference Table

Command Code	Command Name	Default Value	Access Type	Data Bytes	Transfer type	Data Format	DATA UNITS
0x61	TON_RISE	30ms	R/W	2	word	linear11	mSec
0x79	STATUS_WORD	N/A	Read	2	word	Bit field	N/A
0x7A	STATUS_VOUT	N/A	Read	1	byte	Bit field	N/A
0x7B	STATUS_IOUT	N/A	Read	1	byte	Bit field	N/A
0x7C	STATUS_INPUT	N/A	Read	1	byte	Bit field	N/A
0x7D	STATUS_TEMPERATURE	N/A	Read	1	byte	Bit field	N/A
0x88	READ_VIN	N/A	Read	2	word	linear11	V
0x8B	READ_VOUT	N/A	Read	2	word	VOUT linear	V
0x8C	READ_IOUT	N/A	Read	2	word	linear11	Amps
0x8D	READ_TEMP1	N/A	Read	2	word	linear11	Deg. C
0x98	PMBUS_REVISION	1.2	Read	1	byte	Bit Field	N/A
0x9B	MFR_FW_REV	N/A	Read	3	block	char	N/A
0xD3	MFR_VIN_READ_CAL_GAIN	MS	R/W	2	word	Uint16	N/A
0xD4	MFR_VIN_READ_CAL_OFF	MS	R/W	2	word	Uint16	N/A
0xE0	MFR_C1_C2_ARA_CONFIG	0x01	R/W	1	byte	Bit field	N/A
0xE1	MFR_C2_LOGIC	0x01	R/W	1	byte	Bit field	N/A
0xE6	MFR_PGOOD_POLARITY	0x01	R/W	1	byte	Bit field	N/A
0x9C	MFR_MOD_DATE_LOC_SN	China. SZ	Read	9	block	char	N/A

SOLDERING INFORMATION

Soldering

The ADO300-48S12-6L(I) is intended for standard manual, reflow or wave soldering.

When reflow soldering is used, the temperature on pins is specified to maximum 260°C for maximum 10s.

When wave soldering is used, the temperature on pins is specified to maximum 260°C for maximum 7s.

When soldering by hand, the iron temperature should be maintained at 300°C ~ 380°C and applied to the converter pins for less than 10s. Longer exposure can cause internal damage to the converter.

Cleaning of solder joint can be performed with cleaning solvent IPA or simulative.

The ADO300-48S12B-6L(I) is intended for standard manual or wave soldering.

When wave soldering is used, the temperature on pins is specified to maximum 255°C for maximum 7s.

When soldering by hand, the iron temperature should be maintained at 300°C ~ 380°C and applied to the converter pins for less than 10s. Longer exposure can cause internal damage to the converter.

Cleaning of solder joint can be performed with cleaning solvent IPA or simulative.

For module with the baseplate, they are intended for wave soldering assembly onto system boards; please do not subject such modules through reflow temperature profile.

RECORD OF REVISION AND CHANGES

Issue	Date	Description	Originators
1.0	06.28.2016	First Issue	A.Li
1.1	10.03.2016	Update the picture	K. Wang
1.2	11.26.2016	Update by the documents given by marketing	A.Li
1.3	11.30.2016	Updated the Vout_margin_high value	A.Li
1.4	5.31.2017	Delete PMBus™ Address part	A.Li
1.5	12.08.2017	Update the trim characteristic	A. Zhang
1.6	02.05.2018	Update the specification	K. Wang
1.7	03.21.2018	Update the specification	K. Wang
1.8	09.19.2018	Update the mechanical drawing	K. Wang
1.9	05.15.2019	Update the trim formula Update some spec	K. Wang
2.0	03.11.2020	Update Mechanical Drawing	K. Wang
2.1	08.18.2020	1. Update 62368 2. Update information for GG	K. Wang
2.2	03.31.2021	Update Mechanical Drawing Add ADO300-48S12B-4L Update safety part	V. Guo



For international contact information,
visit advancedenergy.com.

powersales@aei.com (Sales Support)
productsupport.ep@aei.com (Technical Support)
+1 888 412 7832

ABOUT ADVANCED ENERGY

Advanced Energy (AE) has devoted more than three decades to perfecting power for its global customers. AE designs and manufactures highly engineered, precision power conversion, measurement and control solutions for mission-critical applications and processes.

Our products enable customer innovation in complex applications for a wide range of industries including semiconductor equipment, industrial, manufacturing, telecommunications, data center computing, and medical. With deep applications know-how and responsive service and support across the globe, we build collaborative partnerships to meet rapid technological developments, propel growth for our customers, and innovate the future of power.

PRECISION | POWER | PERFORMANCE

Specifications are subject to change without notice. Not responsible for errors or omissions. ©2020 Advanced Energy Industries, Inc. All rights reserved. Advanced Energy®, and AE® are U.S. trademarks of Advanced Energy Industries, Inc.